

Project Name:	Type:
Part Number:	Date:

SELECTFIT 6" RETROFIT DOWNLIGHT

SPECIFICATION FEATURES

- **Mechanical** - SELECTFIT, with integrated driver, retrofits existing commercial housings and is field accessible from below the ceiling. Stainless steel spring action clips accommodate 1/2" to 2" ceiling thicknesses.
- **Electrical** - Field select from three lumen outputs using SelectDrive technology. Universal 120-277V or 120V only, 50/60 Hz drivers available. Universal 0-10V drivers dimmable to 5% with low end cutoff. 120V drivers are dimmable to 10% using TRIAC or ELV dimmers.
- **Optical** - Self flanged spun aluminum reflector, painted matte white. Optional clear aluminum trim insert available. High resistance polycarbonate optical lens, with smooth diffusion. 90° beam angle. Field select color temperature between either 3000K/3500K/4000K or 2700/5000K. LED binned to 3-step SDCM to ensure color uniformity, with minimum 80 CRI.
- **Thermal** - Die cast heat sink maximizes passive thermal management and achieves a L70 rated lifetime of 50,000 hours. Ambient temperature rated from -13°F to 95°F (-25°C to 35°C).
- **Compliance and Warranty** - ETL Classified and Listed for wet locations. Certified air-tight per ASTM 283-04. IC Rated for direct contact with insulation. Complies with FCC 47CFR Part 15B consumer limits for EMI/RFI emissions. 5 year parts warranty for complete fixture. Optional 10 Year Extended Warranty available, subject to same terms, conditions and installation requirements as standard 5 Year Warranty.



110422



BENEFITS

- Field select lumen output
- Field select CCT
- Quick and easy installation
- 0-10V or 120V dimmable
- Long life time, L70 Rated for 50,000 hours

APPLICATIONS

- Commercial
- Educational
- Retail
- Hospitality
- Outdoor Under Covered Ceilings

ORDERING INFORMATION

Series	Size	CRI	CCT	Dimming
<input checked="" type="checkbox"/> SLFT SELECTFIT	<input checked="" type="checkbox"/> 6 6" 700 / 1,000 / 1,500lm	<input checked="" type="checkbox"/> 80 CRI 80	<input type="checkbox"/> CCTS Selectable CCT 3000 / 3500 / 4000K <input type="checkbox"/> CCT2750* Selectable CCT 2700 / 5000K	<input type="checkbox"/> DIM120V 120V - Line voltage dimming <input type="checkbox"/> DIM010UNV 120-277V - 0-10V dimming

*Available in DIM010UNV only

LINE DRAWINGS

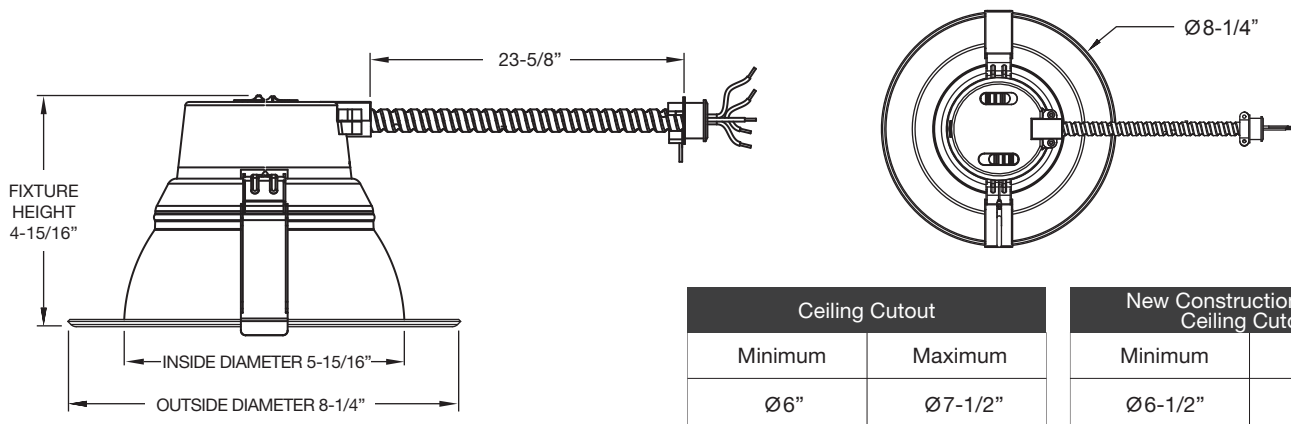

Ceiling Cutout		New Construction Frame Ceiling Cutout	
Minimum	Maximum	Minimum	Maximum
Ø6"	Ø7-1/2"	Ø6-1/2"	Ø7-1/4"



SELECTFIT 6" RETROFIT DOWNLIGHT

TECHNICAL INFORMATION						
Dimming	Input Voltage	Input Frequency	Input Current	Input Power	THD Power	Power Factor
DIM120	120V	50 / 60Hz	0.07 / 0.09 / 0.13A	8 / 10 / 15W	<20%	>0.9
DIM010VUNV	120V	50 / 60Hz	0.06 / 0.08 / 0.13A	8 / 10 / 15W	<20%	>0.9
	277V		0.03 / 0.04 / 0.06A			

PHOTOMETRY

SLFT6/80CCTS/DIM120V (3500K Selected, High)

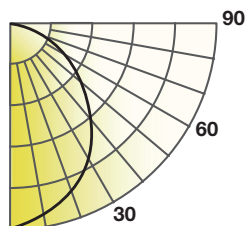

Lumens: 1696 lm
 Power: 15 W
 Efficacy: 112 lm/W
 CRI: 80+
 Spacing Criteria: 1.25
 Beam Angle: 89°

Candlepower Distribution	
Angle (°)	Average (cd)
0	850
5	845
15	807
25	725
35	507
45	415
55	231
65	101
75	45
85	7
90	0

Initial Footcandles		
Height (ft)	Fc	Diameter (ft)
8	13	15
9	10	17
10	9	19
12	6	23
15	4	29

Zonal Lumen Summary		
Zone	Lumens	%Fixt
0-30	639	38
0-40	1007	59
0-60	1540	91
0-90	1696	100

Lumen Output Coefficient			
CCT	3000K	3500K	4000K
Low Lumen output	0.50	0.53	0.51
Med Lumen output	0.63	0.67	0.65
High Lumen output	0.95	1.00	0.97

SLFT6/80CCT2750/DIM010UNV (5000K Selected, High)

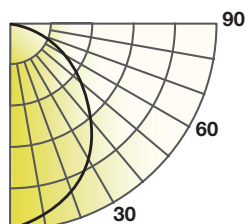

Lumens: 1573 lm
 Power: 15 W
 Efficacy: 107 lm/W
 CRI: 80+
 Spacing Criteria: 1.25
 Beam Angle: 90°

Candlepower Distribution	
Angle (°)	Average (cd)
0	784
5	779
15	745
25	668
35	547
45	387
55	213
65	85
75	43
85	6
90	0

Initial Footcandles		
Height (ft)	Fc	Diameter (ft)
8	12	16
9	10	18
10	8	20
12	5	24
15	3	29

Zonal Lumen Summary		
Zone	Lumens	%Fixt
0-30	590	38
0-40	931	59
0-60	1427	91
0-90	1573	100

Lumen Output Coefficient		
CCT	2700K	5000K
Low Lumen output	0.52	0.54
Med Lumen output	0.65	0.68
High Lumen output	0.98	1.00



SELECTFIT 6" RETROFIT DOWNLIGHT

PERFORMANCE

SLFT6/80CCTS/DIMxxx – LOW/MEDIUM/HIGH – 8 / 10 / 15W - NOMINAL*

CCT	3000K			3500K			4000K		
	Low	Med	High	Low	Med	High	Low	Med	High
Output									
Lumens	803	1019	1529	851	1075	1605	819	1043	1557
LPW	100	102	102	106	108	107	102	104	104

SLFT6/80CCT2750/DIMxxx – LOW/MEDIUM/HIGH – 8 / 10 / 15W - NOMINAL*

CCT2750	2700K			5000K		
	Low	Med	High	Low	Med	High
Output						
Lumens	803	1004	1514	834	1051	1545
LPW	100	100	101	104	105	103

*The above values are nominal only and may vary slightly depending on the dimming and voltage applied







ACCESSORY ORDERING INFORMATION

Product	Model	Description	Pictures	Dimensions
35158	SLFT/TRIM6/CC	6" Clear Trim Insert (Field Installation)		
98568	GOOFRING6	6" Goof Ring - Outer Diameter 10-1/2"		
35122	NCFJB6	New construction frame for T-Grid ceilings and stud/joist mounting		
35126	NCFBFB	Field Installable Butterfly Brackets For New Construction Frame		
35125	NCFEMB	Field Installable Emergency Bracket For New Construction Frame		
98501	NCPLATE/T4689	New Construction Plate for T-Grid ceilings		
98502	NCPLATE468	New Construction Plate for Stud/Joist ceilings		

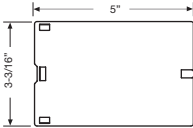

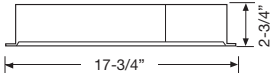
SELECTFIT 6" RETROFIT DOWNLIGHT

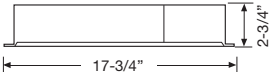
ACCESSORY ORDERING INFORMATION

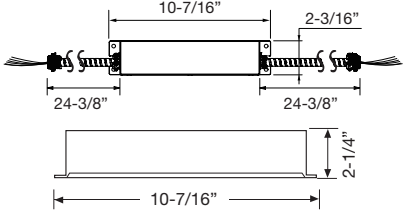
Product	Model	Description	Pictures	Dimensions
98583	NCPLATEJB	Junction box for New Construction Plates		
58012	35EMINVERTER	35W Emergency Inverter (Field Installation)		
58013	35EMINVERTER/CEC	California Title 20 Compliant 35W Emergency Inverter (Field Installation)		
98003	23EMDRIVER	California Title 20 Compliant 23W Emergency LED Driver (Field Installation)		

ORDERING GUIDE

Product	Model
98542	SLFT6/80CCTS/DIM120V
98543	SLFT6/80CCTS/DIM010UNV
98544	SLFT6/80CCT2750/DIM010UNV

10 YEAR EXTENDED WARRANTY

Model	SLFT6/10YEARWARRANTY

Note: All rights reserved. All sizes and specifications are subject to change at any time without notice.