

Project Name:	Type:
Part Number:	Date:

THINFIT 6" COMMERCIAL DOWNLIGHT

SPECIFICATION FEATURES

- **Mechanical** - Shallow die cast aluminum heat sink with a low profile external driver is ideal for new or remodel construction. Two rugged spring clips allow for both easy installation and field accessibility below the ceiling.
- **Electrical** - 120V voltage, 50/60Hz external driver, dims to 10% using most forward and reverse phase dimmers. Plenum rated cable with quick connect for easy installation. Go to www.greencreative.com for complete dimmer compatibility list.
- **Optical** - Edge lighting technology featuring a PMMA light guide plate and smooth polycarbonate lens ensures an even light emitting surface. Available in 2700K, 3000K and 4000K with a minimum of 90 CRI.
- **Thermal** - Die cast aluminum heat sink with it's edge lighting design maximizes thermal dissipation. L70 rated lifetime of 50,000 hours. Fixture operating temperature: -4°F to 95°F (-25°C to 35°C)
- **Compliance and warranty** - ETL Listed for wet location. Certified air-tight per ASTM 283-04, IC rated for direct contact with insulation. 5 year parts warranty for complete fixture.



062923



BENEFITS

- Quick and easy installation with spring action clip
- External driver with quick connector for easy wiring
- Suitable for shallow ceiling applications
- Install almost everywhere with Wet Location, IC and Air-tight ratings
- Edge lighting technology for gentle and smooth diffusion

APPLICATIONS

- Commercial
- Residential
- Educational
- Hospitality
- Retail

ORDERING INFORMATION

Series	Size	CRI	CCT	Driver
<input checked="" type="checkbox"/> 12NCDL New Construction Downlight 12W	<input checked="" type="checkbox"/> R6DIM 6"	<input checked="" type="checkbox"/> 9 CRI 90	<input type="checkbox"/> 27 2700K <input type="checkbox"/> 30 3000K <input type="checkbox"/> 40 4000K	<input checked="" type="checkbox"/> EXT 120V - Line voltage dimming

LINE DRAWINGS

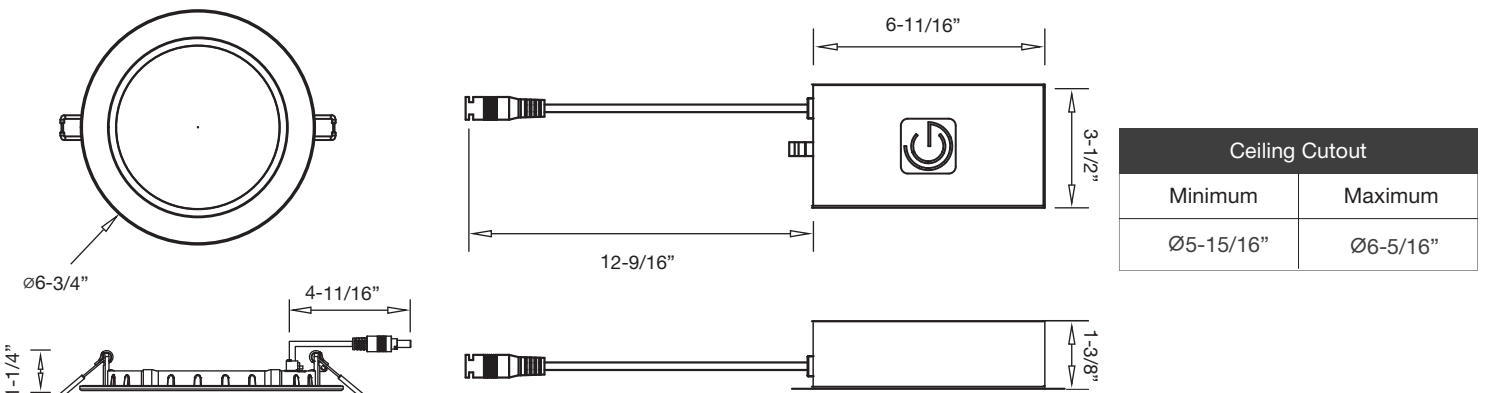

THINFIT 6" COMMERCIAL DOWNLIGHT

TECHNICAL INFORMATION

Dimming	Input Voltage	Input Frequency	Input Current	Input Power	THD Power	Power Factor
Forward or Reverse Phase	120V	50 / 60Hz	0.10A	12W	<20%	>0.9

PHOTOMETRY

12NCDLR6DIM/930/EXT

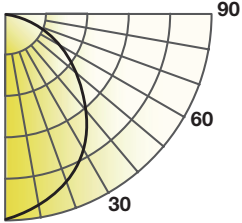

Lumens: 982 lm
 Power: 12 W
 Efficacy: 80 lm/W
 CRI: 90+
 Spacing Criteria: 1.25
 Beam Angle: 113°

Candlepower Distribution	
Angle (°)	Average (cd)
0	339
5	337
15	325
25	301
35	267
45	225
55	176
65	124
75	68
85	15
90	0

Initial Footcandles		
Height (ft)	Fc	Diameter (ft)
8	5	24
9	4	27
10	3	30
12	2	36
15	2	45

Zonal Lumen Summary		
Zone	Lumens	%Fixture
0-30	263	27
0-40	433	44
0-60	766	78
0-90	982	100

Coefficient		
2700K	3000K	4000K
0.99	1.00	1.10

PERFORMANCE











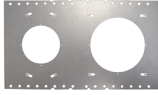
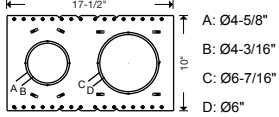
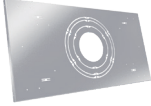
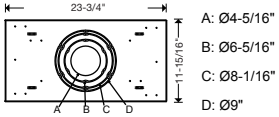

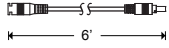

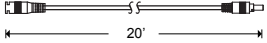

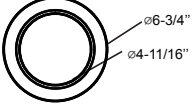

12NCDLR6DIM/9xx/EXT

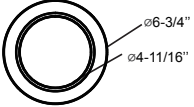
	2700K	3000K	4000K
CCT	2700K	3000K	4000K
Lumens	969	982	1078
LPW	79	80	86

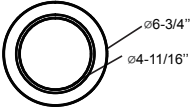
ORDERING GUIDE

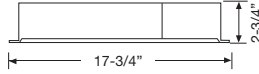
Product	Model
98107	12NCDLR6DIM/927/EXT
98108	12NCDLR6DIM/930/EXT
98109	12NCDLR6DIM/940/EXT

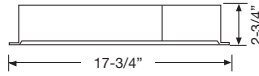
THINFIT 6" COMMERCIAL DOWNLIGHT

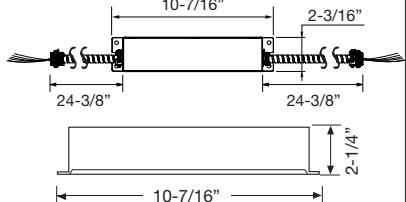
ACCESSORY ORDERING INFORMATION				
Product	Model	Description	Pictures	Dimenions
98280	NCDL46RPLATE	4" & 6" THINFIT EXT Series New Construction Plate for Stud/Joist Mounting		 A: Ø4-5/8" B: Ø4-3/16" C: Ø6-7/16" D: Ø6"
98501	NCPLATE/T4689	New Construction or Remodel Plate for T-Grid Ceilings		 A: Ø4-5/16" B: Ø6-5/16" C: Ø8-1/16" D: Ø9"
98236	NCDLCON6	THINFIT EXT 120V - 6 foot extension cable		
98237	NCDLCON20	THINFIT EXT 120V - 20 foot extension cable		
97848	DLNC6GOOF/R	6" THINFIT EXT Series GOOF RING		 Ø8-5/8" Ø6-1/4"
98348	NCDLR6TRIMBL	6" THINFIT EXT Series Black Trim		 Ø6-3/4" Ø4-11/16"
98349	NCDLR6TRIMBN	6" THINFIT EXT Series Brushed Nickel Trim		 Ø6-3/4" Ø4-11/16"
98350	NCDLR6TRIMBZ	6" THINFIT EXT Series Bronze Trim		 Ø6-3/4" Ø4-11/16"
58012	35EMINVERTER	35W Emergency Inverter (Field Installation)		 17-3/4" 2-3/4"
58013	35EMINVERTER/CEC	California Title 20 Compliant 35W Emergency Inverter (Field Installation)		 17-3/4" 2-3/4"
98003	23EMDRIVER	California Title 20 Compliant 23W Emergency LED Driver (Field Installation)		 10-7/16" 2-3/16" 2-1/4" 24-3/8" 24-3/8"

Note: All rights reserved. All sizes and specifications are subject to change at any time without notice.