

| | |
|---------------|-------|
| Project Name: | Type: |
| Part Number: | Date: |

THINFIT 8" COMMERCIAL DOWNLIGHT

SPECIFICATION FEATURES

- **Mechanical** - Shallow die cast aluminum heat sink with a low profile external driver is ideal for new or remodel construction. Two rugged spring clips allow for both easy installation and field accessibility below the ceiling.
- **Electrical** - 120V voltage, 50/60Hz external driver, dims to 10% using most forward and reverse phase dimmers. Plenum rated cable with quick connect for easy installation. Go to www.greencreative.com for complete dimmer compatibility list.
- **Optical** - Edge lighting technology featuring a PMMA light guide plate and smooth polycarbonate lens ensures an even light emitting surface. Available in 2700K, 3000K and 4000K with a minimum of 90 CRI.
- **Thermal** - Die cast aluminum heat sink with it's edge lighting design maximizes thermal dissipation. L70 rated lifetime of 50,000 hours. Fixture operating temperature: -4°F to 95°F (-25°C to 35°C)
- **Compliance and warranty** - ETL Listed for wet location. Certified air-tight per ASTM 283-04, IC rated for direct contact with insulation. 5 year parts warranty for complete fixture.



062923



BENEFITS

- Quick and easy installation with spring action clip
- External driver with quick connector for easy wiring
- Suitable for shallow ceiling applications
- Install almost everywhere with Wet Location, IC and Air-tight ratings
- Edge lighting technology for gentle and smooth diffusion

APPLICATIONS

- Commercial
- Residential
- Educational
- Hospitality
- Retail

ORDERING INFORMATION

| Series | Size | CRI | CCT | Driver |
|---|--|--|---|---|
| <input checked="" type="checkbox"/> 24.5NCDL New Construction Downlight 24.5W | <input checked="" type="checkbox"/> R8DIM 8" | <input checked="" type="checkbox"/> 9 CRI 90 | <input type="checkbox"/> 27 2700K | <input checked="" type="checkbox"/> EXT 120V - Line voltage dimming |
| | | | <input type="checkbox"/> 30 3000K | |
| | | | <input type="checkbox"/> 40 4000K | |

LINE DRAWINGS

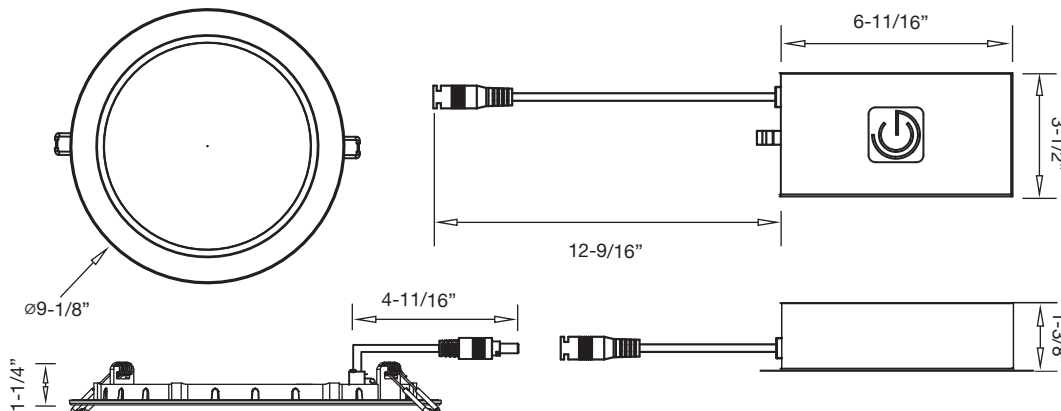

| Ceiling Cutout | |
|-----------------------|-----------------------|
| Minimum | Maximum |
| $\varnothing 8-1/16"$ | $\varnothing 8-7/16"$ |



THINFIT 8" COMMERCIAL DOWNLIGHT

TECHNICAL INFORMATION

| Dimming | Input Voltage | Input Frequency | Input Current | Input Power | THD Power | Power Factor |
|--------------------------|---------------|-----------------|---------------|-------------|-----------|--------------|
| Forward or Reverse Phase | 120V | 50 / 60Hz | 0.20A | 24.5W | <20% | >0.9 |

PHOTOMETRY

24.5NCDLR8DIM/930/EXT

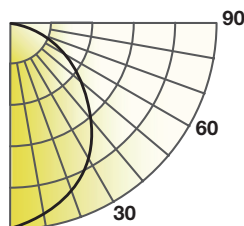

Lumens: 2139 lm
 Power: 24 W
 Efficacy: 89 lm/W
 CRI: 90+
 Spacing Criteria: 1.26
 Beam Angle: 113°

| Candlepower Distribution | |
|--------------------------|--------------|
| Angle (°) | Average (cd) |
| 0 | 740 |
| 5 | 736 |
| 15 | 708 |
| 25 | 656 |
| 35 | 580 |
| 45 | 487 |
| 55 | 382 |
| 65 | 266 |
| 75 | 150 |
| 85 | 37 |
| 90 | 1 |

| Initial Footcandles | | |
|---------------------|----|---------------|
| Height (ft) | Fc | Diameter (ft) |
| 8 | 12 | 25 |
| 9 | 9 | 28 |
| 10 | 8 | 31 |
| 12 | 5 | 37 |
| 15 | 3 | 46 |

| Zonal Lumen Summary | | |
|---------------------|--------|----------|
| Zone | Lumens | %Fixture |
| 0-30 | 574 | 27 |
| 0-40 | 940 | 44 |
| 0-60 | 1665 | 78 |
| 0-90 | 2139 | 100 |

| Coefficient | | |
|-------------|-------|-------|
| 2700K | 3000K | 4000K |
| 0.96 | 1.00 | 1.09 |

PERFORMANCE

24.5NCDLR8DIM/9xx/EXT











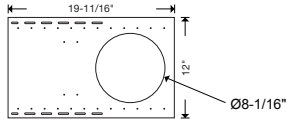
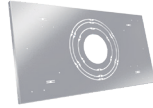
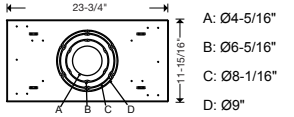

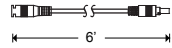

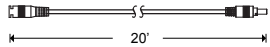

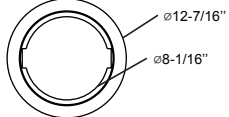

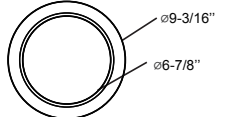
| | 2700K | 3000K | 4000K |
|--------|-------|-------|-------|
| CCT | 2700K | 3000K | 4000K |
| Lumens | 2050 | 2139 | 2325 |
| LPW | 83 | 89 | 97 |

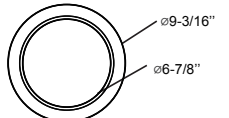
ORDERING GUIDE

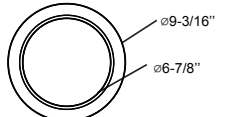
| Product | Model |
|---------|-----------------------|
| 98110 | 24.5NCDLR8DIM/927/EXT |
| 98111 | 24.5NCDLR8DIM/930/EXT |
| 98112 | 24.5NCDLR8DIM/940/EXT |

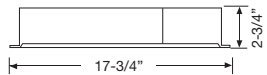

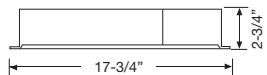
THINFIT 8" COMMERCIAL DOWNLIGHT

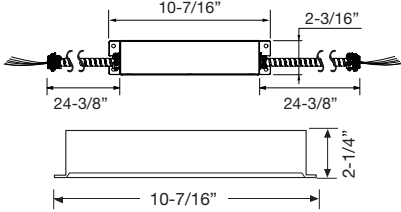
| ACCESSORY ORDERING INFORMATION | | | | |
|--------------------------------|------------------|---|--|---|
| Product | Model | Description | Pictures | Dimenions |
| 98981 | NCDL8RPLATE | 8" THINFIT EXT Series New Construction Plate for Stud/Joist Mounting |  |  |
| 98501 | NCPLATE/T4689 | New Construction or Remodel Plate for T-Grid Ceilings |  |  |
| 98236 | NCDLCON6 | THINFIT EXT 120V - 6 foot extension cable |  |  |
| 98237 | NCDLCON20 | THINFIT EXT 120V - 20 foot extension cable |  |  |
| 98238 | DLNC8GOOF/R | 8" THINFIT EXT Series GOOF RING |  |  |
| 98365 | NCDLR8TRIMBL | 8" THINFIT EXT Series Black Trim |  |  |
| 98366 | NCDLR8TRIMBN | 8" THINFIT EXT Series Brushed Nickel Trim |  |  |
| 98367 | NCDLR8TRIMBZ | 8" THINFIT EXT Series Bronze Trim |  |  |
| 58012 | 35EMINVERTER | 35W Emergency Inverter (Field Installation) |  |  |
| 58013 | 35EMINVERTER/CEC | California Title 20 Compliant 35W Emergency Inverter (Field Installation) |  |  |
| 98003 | 23EMDRIVER | California Title 20 Compliant 23W Emergency LED Driver (Field Installation) |  |  |

Note: All rights reserved. All sizes and specifications are subject to change at any time without notice.