

|               |       |
|---------------|-------|
| Project Name: | Type: |
| Part Number:  | Date: |



GREENCREATIVE

# INNOFIT PLUS SERIES

## SPECIFICATION FEATURES

- Mechanical** - The INNOFIT PLUS Downlight is built with a die cast aluminum housing and proprietary integrated IC-rated potted driver providing a great thermal management system to ensure the long life of electronic components. This series is for both new construction and retrofit applications, it can be installed directly into drywall or ceiling grid. Stainless steel spring action clips allow for both easy direct installation from 1/2" to 2" ceiling thicknesses and field accessibility below the ceiling for service or replacement. Post painted in matte white for standard fixture.
- Electrical** - Field select from three lumen outputs using SelectDrive technology. There are 120V ELV/TRIAC Dimming or 0-10V Dimming drivers options for maximum adaptability in any spaces whether it's commercial, residential or mixed. Rated for 120 to 277V, 50/60 Hz the driver is 0-10V dimmable to 5% with low-end cut off. Rated for 120V, the driver is Forward and Reverse phase dimmable down to 10%. Please consult dimmer compatibility for additional information. Sound rating <22db.
- Optical** - Self flanged spun aluminum reflector, painted with high reflection matte white offers a uniform, comfortable appearance. High resistance and non yellowing polycarbonate lens creates a low-glare wide angle light diffusion. Featuring SelectKelvin technology, CCT are adjustable to 3000K/3500K/4000K with switches in the field to meet the requirements of numerous applications. LED binning within 3 SDCM maximum. Offered in minimum 80 CRI. 105° optical wide beam angle standard.
- Thermal** - Die cast heat sink maximizes passive thermal management and achieves a L70 calculated lifetime of 100,000 hours, at 25°C, meeting TM-21-19 requirements. Ambient temperature rated from -13°F to 113°F (-25°C to 45°C). IC installation for IC rated parts limited to ambient temperature +35°C /95.0°F for 4"/6"/8" and +30°C /86.0°F for 9.5".
- Compliance and Warranty** – ETL Classified and Listed for wet location from the bottom once properly installed. Certified air-tight per ASTM 283-04. Complies with FCC 47CFR Part 15B consumer limits for EMI/RFI emissions at 120V. Suitable for use in clothes closets when installed in accordance with the NEC 410.16 spacing requirements. All the items are certified IC for direct contact with insulation. 5 Year Warranty for complete fixture. Optional 10 Year Extended Warranty available, subject to same terms, conditions and installation requirements as standard 5 Year Warranty.

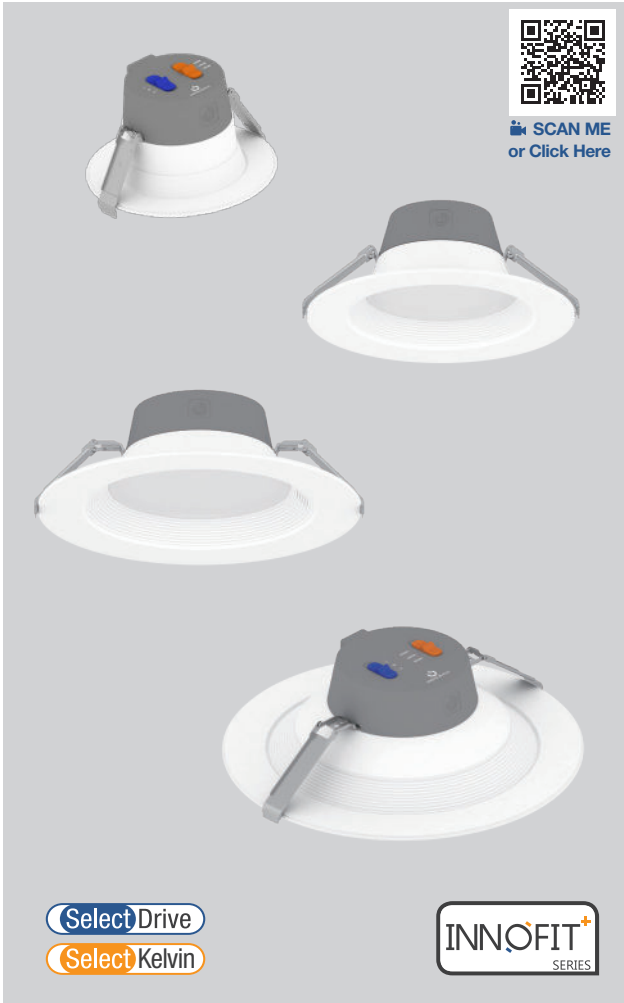

SCAN ME or Click Here

060123



## BENEFITS

- Up to 140LPW high light efficacy
- 120V and 0-10V Dimming options provide the easy remodeling, direct mount or retrofitting installation dimming compatibility
- SelectKelvin technology to choose from three color temperatures including 3000K, 3500K, 4000K
- SelectDrive technology allow to select from 3 lumen outputs
- Install virtually anywhere with Wet Location, IC rated models and Air-tight ratings
- Long life time in high ambient temperature range installation

## APPLICATIONS

- Commercial
- Retail
- Hospitality
- Education
- Outdoor under covered ceilings



# INNOFIT PLUS SERIES

## ORDERING INFORMATION

ORDERING EXAMPLE: INFTP6/8CCT3S/DIM010UNV

| Model Series                           | Size                                | CRI                 | CCT  | Driver   |
|--|-------------------------------------|---------------------|--|--|
| <b>INFTP</b><br>INNOFIT PLUS Downlight | <b>4</b><br>4" 700/1050/1400lm      | <b>8</b><br>CRI 80+ | <b>CCT3S</b><br>Selectable CCT 3000 / 3500 / 4000K | <b>DIM010UNV</b><br>120-277V, 50/60Hz. 0-10V dimming at 120-277V. (Dimmable to 5%)                         |
|  | <b>6</b><br>6" 1180/1700/2100lm     |                     |  | <b>DIM120V<sup>1</sup></b><br>120V, 50/60Hz, Forward/Reverse phase dimming at 120V only. (Dimmable to 10%) |
|  | <b>8</b><br>8" 1560/2080/3000lm     |                     |  |  |
|  | <b>9.5</b><br>9.5" 2100/3150/3650lm |                     |  |  |

<sup>1</sup> DIM120V only available in 6" and 8"

## LINE DRAWINGS

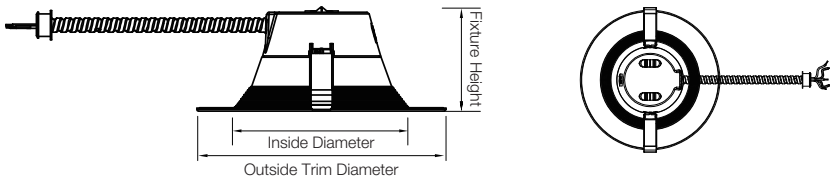

| Fixture  | Inside Diameter | Outside Trim Diameter | Fixture Height |
|----------|-----------------|-----------------------|----------------|
| INFTP4   | 4-1/16"         | 5-7/8"                | 3-7/16"        |
| INFTP6   | 5-15/16"        | 8-5/16"               | 3-7/16"        |
| INFTP8   | 7-1/2"          | 10-1/4"               | 3-7/16"        |
| INFTP9.5 | 8-7/16"         | 11-1/4"               | 3-7/16"        |

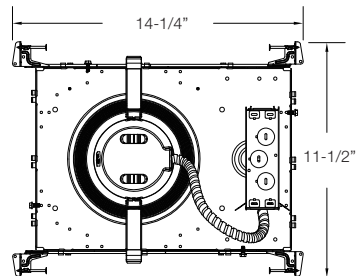
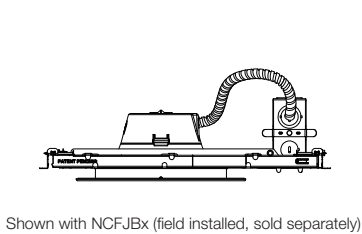

| Remodel / Retrofit / Direct Mount Ceiling Cutout |         |          |  |
|--|---------|----------|--|
| Type   | Minimum | Maximum  |  |
| INFTP4/8CCT3S/DIM010UNV                          | 4-1/8"  | 5-1/8"   |  |
| INFTP6/8CCT3S/DIM010UNV                          | 6-1/16" | 7-1/2"   |  |
| INFTP6/8CCT3S/DIM120V                            | 6-1/16" | 7-1/2"   |  |
| INFTP8/8CCT3S/DIM010UNV                          | 7-9/16" | 9-7/16"  |  |
| INFTP8/8CCT3S/DIM120V                            | 7-9/16" | 9-7/16"  |  |
| INFTP9.5/8CCT3S/DIM010UNV                        | 8-9/16" | 10-7/16" |  |

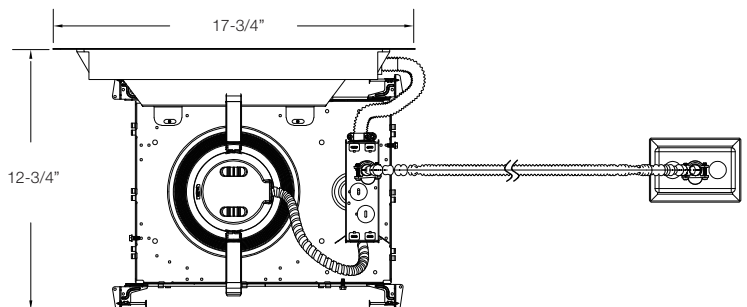
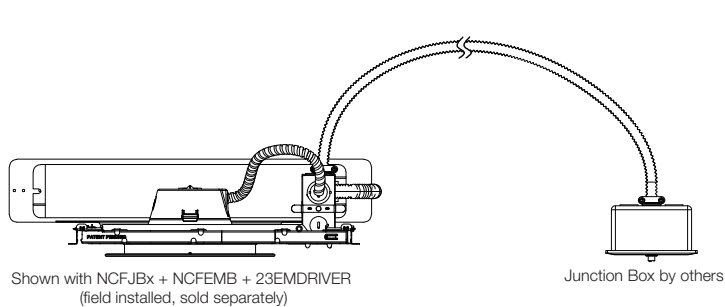



# INNOFIT PLUS SERIES

## TECHNICAL INFORMATION

| Type | Dimming   | Input Voltage | Input Frequency | Input Current | Input Power   | THD Power | Power Factor | Flicker Index | Sound Rating |
|------|-----------|---------------|-----------------|---------------|---------------|-----------|--------------|---------------|--------------|
| 4"   | 0-10V     | 120-277V      | 50-60Hz         | 44mA          | 6 / 9 / 12W   | <20%      | >0.9         | <30%          | <22db        |
| 6"   | 0-10V     | 120-277V      |                 | 135mA         | 9 / 13 / 16W  |           |              |               |              |
| 8"   | 0-10V     | 120-277V      |                 | 194mA         | 12 / 16 / 23W |           |              |               |              |
| 9.5" | 0-10V     | 120-277V      |                 | 234mA         | 16 / 24 / 28W |           |              |               |              |
| 6"   | ELV/TRIAC | 120V          |                 | 134mA         | 9 / 13 / 16W  |           |              |               |              |
| 8"   | ELV/TRIAC | 120V          |                 | 192mA         | 12 / 16 / 23W |           |              |               |              |

## NOMINAL PERFORMANCE











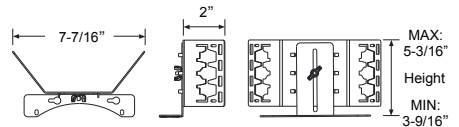

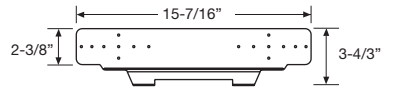
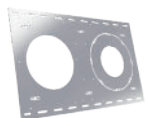
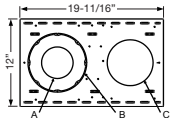

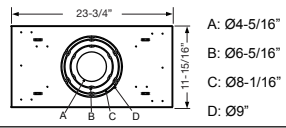

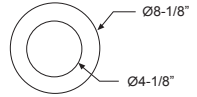
| Product                   | Wattage (W) | 3000KCCT / CRI80 |                | 3500KCCT / CRI80 |                | 4000KCCT / CRI80 |                |
|---------------------------|-------------|------------------|----------------|------------------|----------------|------------------|----------------|
|                           |             | Lumens (lm)      | Efficacy (LPW) | Lumens (lm)      | Efficacy (LPW) | Lumens (lm)      | Efficacy (LPW) |
| INFTP4/8CCT3S/DIM010UNV   | 6           | 680              | 113            | 700              | 117            | 700              | 117            |
|                           | 9           | 1,015            |                | 1,050            |                | 1,050            |                |
|                           | 12          | 1,350            |                | 1,400            |                | 1,400            |                |
| INFTP6/8CCT3S/DIM010UNV   | 9           | 1,130            | 126            | 1,180            | 131            | 1,180            | 131            |
|                           | 13          | 1,640            |                | 1,700            |                | 1,700            |                |
|                           | 16          | 2,000            |                | 2,100            |                | 2,100            |                |
| INFTP8/8CCT3S/DIM010UNV   | 12          | 1,510            | 126            | 1,560            | 130            | 1,560            | 130            |
|                           | 16          | 2,015            |                | 2,080            |                | 2,080            |                |
|                           | 23          | 2,900            |                | 3,000            |                | 3,000            |                |
| INFTP9.5/8CCT3S/DIM010UNV | 16          | 2,000            | 126            | 2,100            | 131            | 2,100            | 131            |
|                           | 24          | 3,000            |                | 3,150            |                | 3,150            |                |
|                           | 28          | 3,500            |                | 3,650            |                | 3,650            |                |
| INFTP6/8CCT3S/DIM120V     | 9           | 1,130            | 126            | 1,180            | 131            | 1,180            | 131            |
|                           | 13          | 1,640            |                | 1,700            |                | 1,700            |                |
|                           | 16          | 2,000            |                | 2,100            |                | 2,100            |                |
| INFTP8/8CCT3S/DIM120V     | 12          | 1,510            | 126            | 1,560            | 130            | 1,560            | 130            |
|                           | 16          | 2,015            |                | 2,080            |                | 2,080            |                |
|                           | 23          | 2,900            |                | 3,000            |                | 3,000            |                |

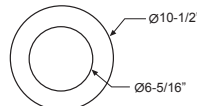
## ACCESSORY ORDERING INFORMATION

| Product | Model    | Description   | Pictures | Dimensions |
|---------|----------|---|----------|------------|
| 35121   | NCFJB4   | 4" New Construction Frame for T-Grid ceilings and stud/joist mounting   |          |            |
| 35122   | NCFJB6   | 6" New Construction Frame for T-Grid ceilings and stud/joist mounting   |          |            |
| 35123   | NCFJB8   | 8" New Construction Frame for T-Grid ceilings and stud/joist mounting   |          |            |
| 35124   | NCFJB9.5 | 9.5" New Construction Frame for T-Grid ceilings and stud/joist mounting |          |            |

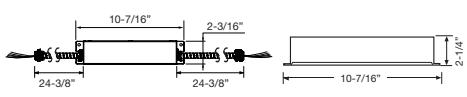

# INNOFIT PLUS SERIES

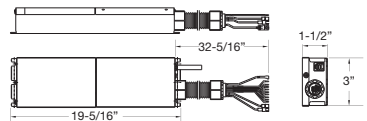
| ACCESSORY ORDERING INFORMATION |                   |  |  |  |
|--------------------------------|-------------------|--|--|--|
| Product                        | Model             | Description  | Pictures   | Dimensions   |
| 35126                          | NCFBFB            | Field Installable Butterfly Brackets For New Construction Frame  |    |  <p>7-7/16" (width)<br/>2" (height)<br/>MAX: 5-3/16" Height<br/>MIN: 3-9/16" Height</p>   |
| 35125                          | NCFEMB            | Field Installable Brackets For emergency Driver or Inverter with New Construction Frame  |    |  <p>15-7/16" (length)<br/>2-3/8" (height)<br/>3-4/3" (height)</p>   |
| 98502                          | NCPLATE468        | 4", 6" and 8" New Construction Plate for Stud/Joist Mounting   |    |  <p>19-11/16" (width)<br/>12" (height)<br/>A: Ø4-5/16"<br/>B: Ø8-1/16"<br/>C: Ø6-5/16"</p>  |
| 98501                          | NCPLATE/T4689     | New Construction or Remodel Plate for T-Grid Ceilings  |    |  <p>23-3/4" (width)<br/>11-15/16" (height)<br/>A: Ø4-5/16"<br/>B: Ø6-5/16"<br/>C: Ø8-1/16"<br/>D: Ø9"</p>                           |
| 98569                          | GOOFRING4         | 4" Goof Ring - Outer Diameter 8-1/8"   |   |  <p>Ø8-1/8" (outer diameter)<br/>Ø4-1/8" (inner diameter)</p>  |
| 98568                          | GOOFRING6         | 6" Goof Ring - Outer Diameter 10-1/2"  |  |  <p>Ø10-1/2" (outer diameter)<br/>Ø6-5/16" (inner diameter)</p>   |
| 98567                          | GOOFRING8         | 8" Goof Ring - Outer Diameter 12-1/2"  |  |  <p>Ø12-1/2" (outer diameter)<br/>Ø8-1/2" (inner diameter)</p>  |
| 98566                          | GOOFRING9.5       | 9.5" Goof Ring - Outer Diameter 14-3/16"   |  |  <p>Ø14-3/16" (outer diameter)<br/>Ø8-7/8" (inner diameter)</p>   |
| 98003                          | 23EMDRIVER        | California Title 20 Compliant 23W Emergency LED Driver (Field Installation)  |  |  <p>10-7/16" (length)<br/>2-3/16" (width)<br/>24-3/8" (length)<br/>24-3/8" (length)<br/>10-7/16" (length)<br/>2-1/4" (height)</p> |
| FHUPS1-UNV-25L-SD              | FHUPS1-UNV-25L-SD | 25W Emergency Micro Inverter for field installation to use with 0-10V Driver options. 100-277VAC (up to 150W with use of 0-10V dimming). CEC Compliant |  |  <p>1-1/2" (height)<br/>3" (height)<br/>19-5/16" (length)<br/>32-5/16" (length)</p>   |



# INNOFIT PLUS SERIES

## ORDERING GUIDE

| Product | Model                     | Case Quantity |
|---------|---------------------------|---------------|
| 36994   | INFTP4/8CCT3S/DIM010UNV   | 6pcs          |
| 36995   | INFTP6/8CCT3S/DIM010UNV   | 6pcs          |
| 36996   | INFTP8/8CCT3S/DIM010UNV   | 6pcs          |
| 36997   | INFTP9.5/8CCT3S/DIM010UNV | 6pcs          |
| 36991   | INFTP6/8CCT3S/DIM120V     | 6pcs          |
| 36992   | INFTP8/8CCT3S/DIM120V     | 6pcs          |

## CERTIFICATION INFORMATION

| Product | Model                     | ES ID#  |
|---------|---------------------------|---------|
| 36991   | INFTP6/8CCT3S/DIM120V     | 2456040 |
| 36992   | INFTP8/8CCT3S/DIM120V     | 2453283 |
| 36994   | INFTP4/8CCT3S/DIM010UNV   | 2453211 |
| 36995   | INFTP6/8CCT3S/DIM010UNV   | 2467215 |
| 36996   | INFTP8/8CCT3S/DIM010UNV   | 2467427 |
| 36997   | INFTP9.5/8CCT3S/DIM010UNV | 2467575 |



# INNOFIT PLUS SERIES

## PHOTOMETRY

INFTP4/8CCT3S/DIM010UNV (at 3500K)

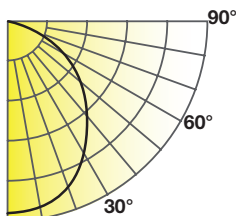

Lumens: 1,352 lm  
 CBCP: 631 cd  
 Power: 12 W  
 Efficacy: 120 lm/W  
 CRI: 80  
 Spacing Criteria: 1.2  
 Beam Angle: 93°

| Candlepower Distribution |              | Initial Footcandles |    |               | Zonal Lumen Summary |        |       |
|--------------------------|--------------|---------------------|----|---------------|---------------------|--------|-------|
| Angle (°)                | Average (cd) | Height (ft)         | Fc | Diameter (ft) | Zone                | Lumens | %Fixt |
| 10                       | 602          | 8                   | 10 | 17            | 0-30                | 468    | 35    |
| 20                       | 561          | 10                  | 6  | 21            | 0-40                | 742    | 55    |
| 30                       | 487          | 12                  | 4  | 25            | 0-60                | 1,191  | 88    |
| 40                       | 387          | 15                  | 3  | 32            | 0-90                | 1,350  | 100   |
| 50                       | 278          | 20                  | 2  | 42            |                     |        |       |
| 60                       | 163          |                     |    |               |                     |        |       |
| 70                       | 72           |                     |    |               |                     |        |       |
| 80                       | 15           |                     |    |               |                     |        |       |
| 90                       | 0            |                     |    |               |                     |        |       |

INFTP6/8CCT3S/DIM010UNV (at 3500K)

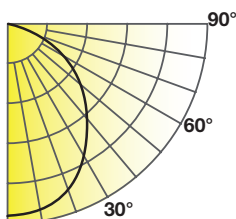

Lumens: 2,078 lm  
 CBCP: 882 cd  
 Power: 16 W  
 Efficacy: 137 lm/W  
 CRI: 80  
 Spacing Criteria: 1.2  
 Beam Angle: 101°

| Candlepower Distribution |              | Initial Footcandles |    |               | Zonal Lumen Summary |        |       |
|--------------------------|--------------|---------------------|----|---------------|---------------------|--------|-------|
| Angle (°)                | Average (cd) | Height (ft)         | Fc | Diameter (ft) | Zone                | Lumens | %Fixt |
| 10                       | 851          | 8                   | 14 | 19            | 0-30                | 660    | 32    |
| 20                       | 792          | 10                  | 9  | 24            | 0-40                | 1,062  | 51    |
| 30                       | 700          | 12                  | 6  | 29            | 0-60                | 1,787  | 86    |
| 40                       | 580          | 15                  | 4  | 36            | 0-90                | 2,075  | 100   |
| 50                       | 444          | 20                  | 2  | 48            |                     |        |       |
| 60                       | 283          |                     |    |               |                     |        |       |
| 70                       | 132          |                     |    |               |                     |        |       |
| 80                       | 19           |                     |    |               |                     |        |       |
| 90                       | 0            |                     |    |               |                     |        |       |

INFTP8/8CCT3S/DIM010UNV (at 3500K)

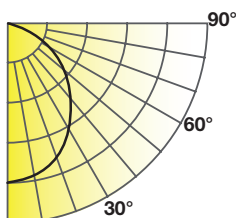

Lumens: 3,026 lm  
 CBCP: 1,191 cd  
 Power: 24 W  
 Efficacy: 141 lm/W  
 CRI: 80  
 Spacing Criteria: 1.2  
 Beam Angle: 106°

| Candlepower Distribution |              | Initial Footcandles |    |               | Zonal Lumen Summary |        |       |
|--------------------------|--------------|---------------------|----|---------------|---------------------|--------|-------|
| Angle (°)                | Average (cd) | Height (ft)         | Fc | Diameter (ft) | Zone                | Lumens | %Fixt |
| 10                       | 1,147        | 8                   | 19 | 21            | 0-30                | 895    | 30    |
| 20                       | 1,071        | 10                  | 12 | 27            | 0-40                | 1,149  | 48    |
| 30                       | 954          | 12                  | 8  | 32            | 0-60                | 2,506  | 83    |
| 40                       | 812          | 15                  | 5  | 40            | 0-90                | 3,021  | 100   |
| 50                       | 645          | 20                  | 3  | 53            |                     |        |       |
| 60                       | 457          |                     |    |               |                     |        |       |
| 70                       | 200          |                     |    |               |                     |        |       |
| 80                       | 47           |                     |    |               |                     |        |       |
| 90                       | 0            |                     |    |               |                     |        |       |



# INNOFIT PLUS SERIES

## PHOTOMETRY

INFTP9.5/8CCT3S/DIM010UNV (at 3500K)

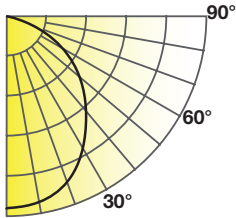

Lumens: 3,771 lm  
CBCP: 1,467 cd  
Power: 28 W  
Efficacy: 143 lm/W  
CRI: 80  
Spacing Criteria: 1.2  
Beam Angle: 107°

| Candlepower Distribution |              | Initial Footcandles |    |               | Zonal Lumen Summary |        |       |
|--------------------------|--------------|---------------------|----|---------------|---------------------|--------|-------|
| Angle (°)                | Average (cd) | Height (ft)         | Fc | Diameter (ft) | Zone                | Lumens | %Fixt |
| 10                       | 1,417        | 8                   | 23 | 21            | 0-30                | 1,105  | 29    |
| 20                       | 1,324        | 10                  | 15 | 27            | 0-40                | 1,790  | 48    |
| 30                       | 1,184        | 12                  | 10 | 32            | 0-60                | 3,097  | 82    |
| 40                       | 1,004        | 15                  | 7  | 40            | 0-90                | 3,764  | 100   |
| 50                       | 796          | 20                  | 4  | 54            |                     |        |       |
| 60                       | 569          |                     |    |               |                     |        |       |
| 70                       | 321          |                     |    |               |                     |        |       |
| 80                       | 77           |                     |    |               |                     |        |       |
| 90                       | 0            |                     |    |               |                     |        |       |

INFTP6/8CCT3S/DIM120V (at 3500K)

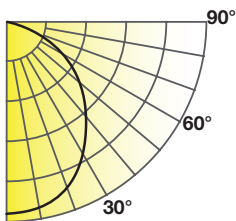

Lumens: 2,023 lm  
CBCP: 857 cd  
Power: 16 W  
Efficacy: 132 lm/W  
CRI: 80  
Spacing Criteria: 1.2  
Beam Angle: 101°

| Candlepower Distribution |              | Initial Footcandles |    |               | Zonal Lumen Summary |        |       |
|--------------------------|--------------|---------------------|----|---------------|---------------------|--------|-------|
| Angle (°)                | Average (cd) | Height (ft)         | Fc | Diameter (ft) | Zone                | Lumens | %Fixt |
| 10                       | 826          | 8                   | 13 | 19            | 0-30                | 641    | 32    |
| 20                       | 769          | 10                  | 9  | 24            | 0-40                | 1,032  | 51    |
| 30                       | 780          | 12                  | 6  | 29            | 0-60                | 1,738  | 86    |
| 40                       | 566          | 15                  | 4  | 37            | 0-90                | 2,020  | 100   |
| 50                       | 433          | 20                  | 2  | 49            |                     |        |       |
| 60                       | 281          |                     |    |               |                     |        |       |
| 70                       | 131          |                     |    |               |                     |        |       |
| 80                       | 19           |                     |    |               |                     |        |       |
| 90                       | 0            |                     |    |               |                     |        |       |

INFTP8/8CCT3S/DIM120V (at 3500K)

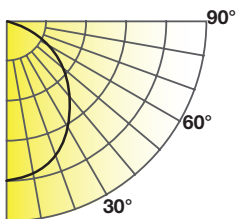

Lumens: 2,907 lm  
CBCP: 1,136 cd  
Power: 24 W  
Efficacy: 128 lm/W  
CRI: 80  
Spacing Criteria: 1.2  
Beam Angle: 106°

| Candlepower Distribution |              | Initial Footcandles |    |               | Zonal Lumen Summary |        |       |
|--------------------------|--------------|---------------------|----|---------------|---------------------|--------|-------|
| Angle (°)                | Average (cd) | Height (ft)         | Fc | Diameter (ft) | Zone                | Lumens | %Fixt |
| 10                       | 1,101        | 8                   | 18 | 19            | 0-30                | 860    | 30    |
| 20                       | 1,027        | 10                  | 11 | 24            | 0-40                | 1,393  | 48    |
| 30                       | 926          | 12                  | 8  | 29            | 0-60                | 2,408  | 83    |
| 40                       | 781          | 15                  | 5  | 37            | 0-90                | 2,902  | 100   |
| 50                       | 619          | 20                  | 3  | 49            |                     |        |       |
| 60                       | 438          |                     |    |               |                     |        |       |
| 70                       | 240          |                     |    |               |                     |        |       |
| 80                       | 48           |                     |    |               |                     |        |       |
| 90                       | 0            |                     |    |               |                     |        |       |

Note: All rights reserved. All sizes and specifications are subject to change at any time without notice.