

Project Name:	Type:
Part Number:	Date:



GREENCREATIVE

SPECFIT 6" NEW CONSTRUCTION

SPECIFICATION FEATURES

- **Mechanical** - Galvanized steel plaster frame. Low profile bar hangers with non-pass through construction and leveling flanges contain integral tee bar clip and preinstalled nail. Bar hangers are adjustable from 13-1/4" to 24-1/2" and can be installed in suspended T-Grid or wood joist ceilings. Attached junction box with quick connect MC cable allows for easy fixture wiring. The reflector's spring action clips allow for a secure installation in ceilings from 1/2" to 2" thick. The reflector opening allows a $\pm 5^\circ$ adjustability for perfect ceiling alignment.
- **Electrical** - Two selectable lumen output driver options with SelectDrive technology. The 120V, 50/60 Hz driver is forward or reverse phase dimmable to 5%. The 120-277V, 50/60 Hz driver is 0-10V dimmable to 5% with a low end cutoff and comes with a 12V auxiliary port that provides power for field installed sensors and control modules. Static lumen output driver options include the Signify Xitanium 1% dimming driver as well as the Lutron 5-Series Ecosystem driver which provides smooth dimming to 5% and the Lutron Hi-Lume 1% EcoSystem driver with Soft-On, Fade-to-Black which dims to 1%. EldoLED ECOdrive and SOLODrive drivers are available in 0-10V and DALI configurations and dim smoothly to 1% and 0.1% respectively. Enlighted compact sensors and Philips EasySense sensors are field installable and directly integrate with the factory provided Philips Xitanium driver and Sensor Ready Bridge.
- **Optical** - Self-flanged plated polycarbonate reflector. 40° optical cutoff. Field interchangeable optical lenses. Five beam distributions range from 15° to 75°. Wall wash field installed accessory. COB LED binned to 3-step SDCM to ensure color uniformity in 2700K, 3000K, 3500K, 4000K or 5000K CCT. Minimum 90 CRI. 97 CRI with TRUE CHROMA available in 3000K only.
- **Thermal** - Die cast heat sink. L70 lifetime of 100,000 hours. Fixture operating temperature: -13°F to +95°F (-25°C to 35°C).
- **Compliance and Warranty** - ETL Listed for Damp locations. Suitable for exterior under canopy mounting when utilizing OUT Outdoor Debris Ingress Protection option. 5 year parts warranty for complete fixture. Optional 10 Year Extended Warranty available, subject to same terms, conditions and installation requirements as standard 5 Year Warranty.



060623



BENEFITS

- Get the right amount of light with SelectDrive technology
- 42° optical cutoff reduces glare and make the space more comfortable
- Reflectors can be easily adjusted $\pm 5^\circ$ from below the ceiling
- Field interchangeable optics ensure smooth light levels
- Large variety of dimming and sensor control options
- Exceptional color rendering and uniformity

APPLICATIONS

- Commercial Office
- Hospitality
- Retail
- Educational
- Healthcare
- Exterior Under Canopy*

*Applicable with OUT Outdoor Debris Ingress Protection option.

DIMENSIONS

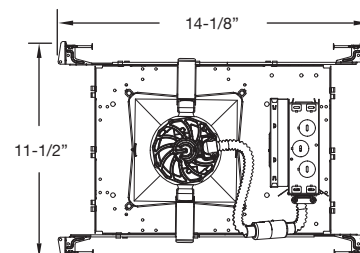
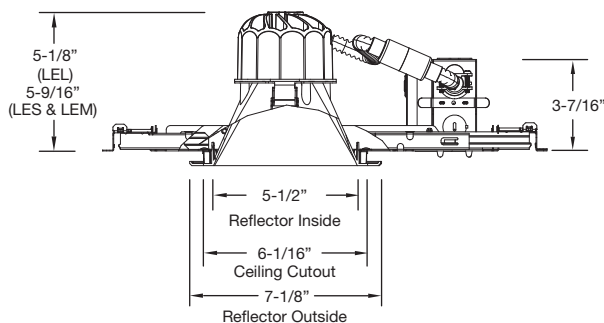



SPECFIT 6" NEW CONSTRUCTION

DIMENSIONS

with / Sensor

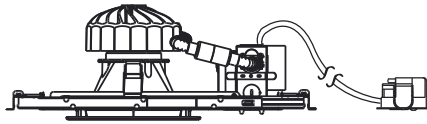

Philips EasySense sensor shown.
Enlighted compact sensor also available.

with / EM

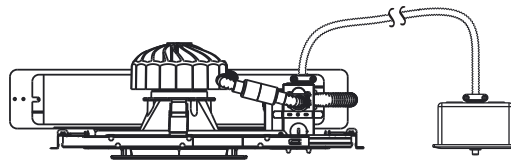

EM Test Switch shown.
Single gang j-box by others.

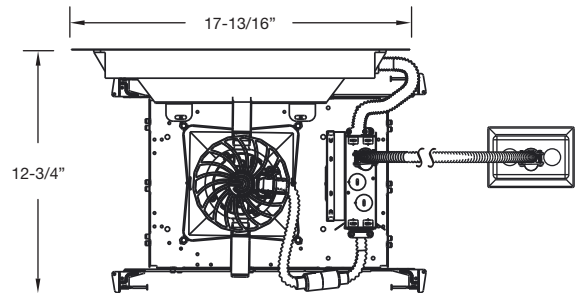
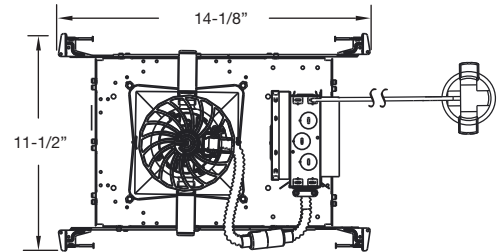

ORDERING EXAMPLE

A complete fixture consists of one light engine and one reflector.

SelectDrive Light Engine: SPFSTS6LEL9035KDIM010UNVMDOUTEM

Reflector: ADS6CC

SelectDrive Light Engines

Frame Housing	Light Engine	CRI	CCT	Driver	Optical Distribution	Options ⁷
<input type="checkbox"/> SPFSTS6 SPECFIT Specfit New Construction 6"	<input type="checkbox"/> LES Small Light Engine 500-700-1000 lumens	<input type="checkbox"/> 90 90+ CRI	<input type="checkbox"/> 27 2700K	<input type="checkbox"/> KDIM120V SelectDrive 120V, 50/60Hz Forward/Reverse Phase 10% dimming	<input type="checkbox"/> SP¹¹ Spot 15° Beam Angle	<input type="checkbox"/> SD347 347V - 240V Step Down Transformer
	<input type="checkbox"/> LEM Medium Light Engine 1500-2000-2500 lumens	<input type="checkbox"/> 97³ 97 CRI 3000K True Chroma	<input type="checkbox"/> 30 3000K	<input type="checkbox"/> KDIM010UNV² SelectDrive 120-277V, 50/60Hz 0-10V 10% dimming	<input type="checkbox"/> MD¹ Medium (Installed Standard) 60° Beam angle	<input type="checkbox"/> EM⁴ 10W Pre-installed Emergency Backup
	<input type="checkbox"/> LEL Large Light Engine 3000-4000-5000 lumens		<input type="checkbox"/> 35 3500K		<input type="checkbox"/> VN Very Narrow 25° Beam angle	<input type="checkbox"/> EM⁴-CEC 10W Pre-installed Emergency Backup California Compliant
			<input type="checkbox"/> 40 4000K		<input type="checkbox"/> NR Narrow 40° Beam angle	<input type="checkbox"/> OUT Outdoor Debris Ingress Protection
			<input type="checkbox"/> 50 5000K		<input type="checkbox"/> WD Wide 75° Beam angle	<input type="checkbox"/> WET¹⁰ Field installable wet location gasketed ring
						<input type="checkbox"/> BAA Buy America(n) Act Compliant

Reflectors

Shape	Finish
<input type="checkbox"/> ADS6 6" Square Reflector	<input type="checkbox"/> CC Clear Diffuse Trim and Flange <input type="checkbox"/> WH Matte White Trim and Flange <input type="checkbox"/> CZ¹² Customized Trim and Flange

¹ Medium Lens Optic comes installed as standard, if other optic distribution selected the lens will ship separately and require field installation. / ² Dims to 5% with low end cutoff. Dimmer compatibility available on website. / ³ CRI97 TRUE CHROMA is only available in 3000K only. It is made to order (MTO) for the lumen values of 3000 and above, including the LEL light engine. / ⁴ EM cannot be combined with SD347 or SD480 option / ⁷ Options are factory installed and come with the Light Engine and Driver. / ¹⁰ Wet location makes the downlight ETL certified for WET location installation, separate gasketed ring will be provided with the light engine for field installation. WET location is not compatible with any sensor options. / ¹¹ SP optic is not available with LEL model. / ¹² Please contact factory for customized finish color or customized reflectors for feasibility and lead times.

SPECFIT 6" NEW CONSTRUCTION

ORDERING EXAMPLE

A complete fixture consists of one light engine and one reflector.

Philips Light Engine W/ Enlighted Micro Sensor: SPFTS6LE259040PSRUNVWENLS-IOT Reflector: ADS6CC	Lutron EcoSystem Light Engine: SPFTS6LE159027LUT-5UNVNR Reflector: ADS6BL
Philips Light Engine W/ EasySense Sensor: SPFTS6LE509030PSRUNWVNES Reflector: ADS6CW	EldoLED Light Engine SOLOdrive: SPFTS6LE209035ELD-S010UNVWD Reflector: ADS6WH

ORDERING INFORMATION

Fixed Output Light Engines

Frame Housing	Light Engine	CRI	CCT	Driver	Optical Distribution	Options ⁷
<input type="checkbox"/> SPFTS6 SPECFIT Specfit New Construction 6"	<input type="checkbox"/> LE05 500 lumens	<input type="checkbox"/> 90 90+CRI	<input type="checkbox"/> 27 2700K	<input type="checkbox"/> PSRUNV Signify 0-10V Driver + Sensor Ready Bridge, 1% Dimming, 120-277V	<input type="checkbox"/> SP¹⁰ Spot 15° Beam Angle	<input type="checkbox"/> SD347 347V - 240V Step Down Transformer
	<input type="checkbox"/> LE07 700 lumens	<input type="checkbox"/> 97³ 97 CRI 3000K True Chroma	<input type="checkbox"/> 30 3000K	<input type="checkbox"/> LUT-1UNV Lutron EcoSystem 1% Dimming, 120-277V	<input type="checkbox"/> MD¹ Medium (Installed Standard) 60° Beam angle	<input type="checkbox"/> EM⁴ 10.7W Emergency Backup
	<input type="checkbox"/> LE10 1,000 lumens		<input type="checkbox"/> 35 3500K	<input type="checkbox"/> LUT-L3DUNV Lutron Hi-Lume 3-Wire 1% Dimming, 120-277V	<input type="checkbox"/> VN Very Narrow 25° Beam angle	<input type="checkbox"/> EM⁴ -CEC California Title 20 Compliant 10.7W Emergency Backup
	<input type="checkbox"/> LE15 1,500 lumens		<input type="checkbox"/> 40 4000K	<input type="checkbox"/> ELD-E010UNV EldoLED ECOdrive 0-10V 1%, 120-277V	<input type="checkbox"/> NR Narrow 40° Beam angle	<input type="checkbox"/> ES⁵ Philips EasySense ceiling mount sensor
	<input type="checkbox"/> LE20 2,000 lumens		<input type="checkbox"/> 50 5000K	<input type="checkbox"/> ELD-EDALIUNV EldoLED ECOdrive DALI 1%, 120-277V	<input type="checkbox"/> WD Wide 75° Beam angle	<input type="checkbox"/> ENLS⁶-IL Enlighted Two Wire ENLIGHTENED ONE Compact Sensor
	<input type="checkbox"/> LE25 2,500 lumens			<input type="checkbox"/> ELD-S010UNV EldoLED SOLOdrive 0-10V 0.1%, 120-277V		<input type="checkbox"/> ENLS⁶-CL Enlighted Two Wire CONNECTED LIGHTING Compact Sensor
	<input type="checkbox"/> LE30 3,000 lumens			<input type="checkbox"/> ELD-SDALIUNV EldoLED SOLOdrive DALI 0.1%, 120-277V		<input type="checkbox"/> ENLS⁶-IOT Enlighted Two Wire IOT Compact Sensor
	<input type="checkbox"/> LE40 4,000 lumens			<input type="checkbox"/> XT010UNV Signify 0-10V Driver 1% Dimming, 120-277V		<input type="checkbox"/> OUT Outdoor Debris Ingress Protection
	<input type="checkbox"/> LE50⁹ 5,000 lumens					<input type="checkbox"/> WET⁹ Field installable wet location gasketed ring
						<input type="checkbox"/> BAA Buy America(n) Act Compliant

Reflectors

Shape	Finish
<input type="checkbox"/> ADS6 6" Square Reflector	<input type="checkbox"/> CC Clear Diffuse Trim and Flange <input type="checkbox"/> WH Matte White Trim and Flange <input type="checkbox"/> CZ¹¹ Customized Trim and Flange

¹ Medium Lens Optic comes installed as standard, if other optic distribution selected the lens will ship separately and require field installation / ³ CRI97 TRUE CHROMA is only available in 3000K only. It is made to order (MTO) for the lumen values of 3000 and above, including the LEL light engine. / ⁴ EM cannot be combined with SD347 or SD480 option / ⁵ Philips EasySense ceiling mounted sensor is only available with the PSRUNV driver / ⁶ Enlighted Two Wire Compact Sensor with ceiling mount is only available with the PSRUNV driver. / ⁷ Options are factory installed and come with the Light Engine and Driver. / ⁸ LE50 is not available with LUT-1UNV. / ⁹ Wet location makes the downlight ETL certified for WET location installation, separate gasketed ring will be provided with the light engine for field installation. WET location is not compatible with any sensor options. / ¹⁰ SP optic is not available with LEL model. / ¹¹ Please contact factory for customized finish color or customized reflectors for feasibility and lead times.



SPECFIT 6" NEW CONSTRUCTION

ACCESSORY ORDERING INFORMATION				
Product	Model	Description	Pictures	Dimensions
98079	ADWAW	Wall Wash (Field Installed on Lens)		
35126	NCFBFB	Set of Two Field Installable Butterfly Brackets For New Construction Rough-in Frame		
35125	NCFEMB	Field Installable Emergency Bracket For New Construction Rough-in Frame		

10 YEAR EXTENDED WARRANTY

Model	SPFTS6 / LE _{xx} / 10YEARWARRANTY*
<p>*Where xx = Fixture Light Engine lumen output designation. Example: 10 Year Warranty Part Number for SPFTS6/LEM or SPFTS6/LE20 Light engine is SPFTS6/LEM/10YEARWARRANTY and SPFTS6/LE20/10YEARWARRANTY respectively.</p>	



SPECFIT 6" NEW CONSTRUCTION

TECHNICAL INFORMATION

Light Engine	Input Voltage	Input Frequency	Input Current	Input Power	THD Power	Power Factor
LESXXXX	120 / 277V	50 / 60Hz	0.115 / 0.047A	13W	<20%	>0.9
LEMXXXX	120 / 277V	50 / 60Hz	0.270 / 0.114A	31.5W	<20%	>0.9
LELXXXX	120 / 277V	50 / 60Hz	0.530 / 0.217A	60W	<20%	>0.9
LE05XXXX	120 / 277V	50 / 60Hz	0.056 / 0.024A	6.5W	<20%	>0.9
LE07XXXX	120 / 277V	50 / 60Hz	0.073 / 0.034A	8.5W	<20%	>0.9
LE10XXXX	120 / 277V	50 / 60Hz	0.112 / 0.047A	13W	<20%	>0.9
LE15XXXX	120 / 277V	50 / 60Hz	0.154 / 0.068A	18W	<20%	>0.9
LE20XXXX	120 / 277V	50 / 60Hz	0.218 / 0.092A	25.5W	<20%	>0.9
LE25XXXX	120 / 277V	50 / 60Hz	0.269 / 0.116A	31.5W	<20%	>0.9
LE30XXXX	120 / 277V	50 / 60Hz	0.318 / 0.133A	37.5W	<20%	>0.9
LE40XXXX	120 / 277V	50 / 60Hz	0.411 / 0.165A	48.5W	<20%	>0.9
LE50XXXX	120 / 277V	50 / 60Hz	0.487 / 0.203A	57.5W	<20%	>0.9

NOMINAL PERFORMANCE

LES (LE05 / LE07 / LE10) - Low / Medium / High - 6.5 / 8.5 / 13W

CCT	2700K			3000K			3500K			4000K			5000K		
	Low	Medium	High	Low	Medium	High	Low	Medium	High	Low	Medium	High	Low	Medium	High
Output**	Im LPW	Im LPW	Im LPW	Im LPW	Im LPW	Im LPW	Im LPW	Im LPW	Im LPW	Im LPW	Im LPW	Im LPW	Im LPW	Im LPW	Im LPW
Finish	Im LPW	Im LPW	Im LPW	Im LPW	Im LPW	Im LPW	Im LPW	Im LPW	Im LPW	Im LPW	Im LPW	Im LPW	Im LPW	Im LPW	Im LPW
Clear Diffuse	500 77	700 82	1,000 80	525 81	735 86	1,050 84	550 85	770 91	1,100 88	575 88	805 95	1,150 92	580 89	810 95	1,165 93
White	495 76	693 82	990 79	520 80	728 86	1,040 83	545 84	762 90	1,089 87	569 88	797 94	1,139 91	574 88	802 94	1,153 92

LEM (LE15 / LE20 / LE25) - Low / Medium / High - 18.0 / 25.5 / 31.5W

CCT	2700K			3000K			3500K			4000K			5000K		
	Low	Medium	High	Low	Medium	High	Low	Medium	High	Low	Medium	High	Low	Medium	High
Output**	Im LPW	Im LPW	Im LPW	Im LPW	Im LPW	Im LPW	Im LPW	Im LPW	Im LPW	Im LPW	Im LPW	Im LPW	Im LPW	Im LPW	Im LPW
Finish	Im LPW	Im LPW	Im LPW	Im LPW	Im LPW	Im LPW	Im LPW	Im LPW	Im LPW	Im LPW	Im LPW	Im LPW	Im LPW	Im LPW	Im LPW
Clear Diffuse	1,600 89	2,125 83	2,500 79	1,632 91	2,169 85	2,550 81	1,664 92	2,210 87	2,600 83	1,696 94	2,253 88	2,650 84	1,713 95	2,275 89	2,677 85
White	1,584 88	2,104 82	2,475 78	1,616 90	2,147 84	2,525 80	1,647 91	2,188 86	2,574 82	1,679 93	2,230 87	2,624 83	1,696 94	2,252 88	2,650 84

LEL (LE30 / LE40 / LE50) - Low / Medium / High - 37.5 / 48.5 / 60.0W

CCT	2700K			3000K			3500K			4000K			5000K		
	Low	Medium	High	Low	Medium	High	Low	Medium	High	Low	Medium	High	Low	Medium	High
Output**	Im LPW	Im LPW	Im LPW	Im LPW	Im LPW	Im LPW	Im LPW	Im LPW	Im LPW	Im LPW	Im LPW	Im LPW	Im LPW	Im LPW	Im LPW
Finish	Im LPW	Im LPW	Im LPW	Im LPW	Im LPW	Im LPW	Im LPW	Im LPW	Im LPW	Im LPW	Im LPW	Im LPW	Im LPW	Im LPW	Im LPW
Clear Diffuse	3,325 89	4,085 84	4,750 79	3,360 90	4,080 84	4,800 80	3,500 93	4,250 88	5,000 83	3,640 97	4,420 91	5,200 87	3,640 97	4,420 91	5,200 87
White	3,292 88	4,044 83	4,703 78	3,326 89	4,039 83	4,752 79	3,465 92	4,208 87	4,950 82	3,604 96	4,376 90	5,148 86	3,604 96	4,376 90	5,148 86

** Lumen output are based on rated lumens, for exact value please refer to the IES files



SPECFIT 6" NEW CONSTRUCTION

PHOTOMETRY

SPFTS6-LES9035-KDIM010-UNV-VN-ADS6CC

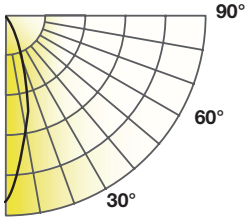

Lumens: 1,220 lm
CBCP: 4,292 cd
Power: 11 W
Efficacy: 98 lm/W
CRI: 90+
Spacing Criteria: 0.42
Beam Angle: 26°

Candlepower Distribution		Initial Footcandles			Zonal Lumen Summary		
Angle (°)	Average (cd)	Height (ft)	Fc	Diameter (ft)	Zone	Lumens	%Fixt
10	2,545	4	236	1.8	0-30	1,094	90%
20	1,189	6	105	2.7	0-40	1,192	98%
30	316	8	59	3.6	0-60	1,219	100%
40	66	10	38	4.5	0-90	1,219	100%
50	12	12	26	5.4			
60	0						
70	0						
80	0						
90	0						

SPFTS6-LES9035-KDIM010-UNV-NR-ADS6CC

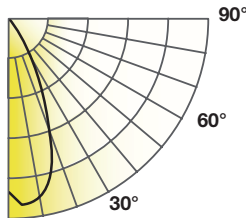

Lumens: 1,240 lm
CBCP: 2,379 cd
Power: 11 W
Efficacy: 100 lm/W
CRI: 90+
Spacing Criteria: 0.67
Beam Angle: 43°

Candlepower Distribution		Initial Footcandles			Zonal Lumen Summary		
Angle (°)	Average (cd)	Height (ft)	Fc	Diameter (ft)	Zone	Lumens	%Fixt
10	2,206	4	205	3.1	0-30	1,084	87%
20	1,371	6	91	4.7	0-40	1,216	98%
30	444	8	51	6.2	0-60	1,239	100%
40	72	10	33	7.8	0-90	1,239	100%
50	12	12	23	9.4			
60	0						
70	0						
80	0						
90	0						

SPFTS6-LES9035-KDIM010-UNV-MD-ADS6CC

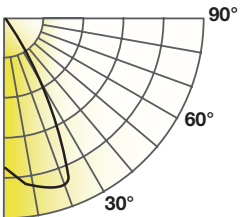

Lumens: 1,257 lm
CBCP: 1,396 cd
Power: 11 W
Efficacy: 101 lm/W
CRI: 90+
Spacing Criteria: 0.90
Beam Angle: 64°

Candlepower Distribution		Initial Footcandles			Zonal Lumen Summary		
Angle (°)	Average (cd)	Height (ft)	Fc	Diameter (ft)	Zone	Lumens	%Fixt
10	1,308	4	121	5.0	0-30	952	76%
20	1,250	6	54	7.5	0-40	1,201	96%
30	696	8	30	10.0	0-60	1,256	100%
40	169	10	19	12.4	0-90	1,256	100%
50	20	12	13	14.9			
60	1						
70	0						
80	0						
90	0						



SPECFIT 6" NEW CONSTRUCTION

PHOTOMETRY

SPFTS6-LES9035-KDIM010-UNV-WD-ADS6CC

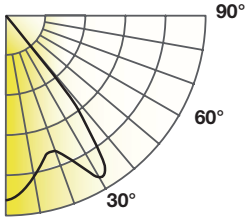

Lumens: 1,250 lm
CBCP: 900 cd
Power: 11 W
Efficacy: 101 lm/W
CRI: 90+
Spacing Criteria: 1.22
Beam Angle: 81°

Candlepower Distribution		Initial Footcandles			Zonal Lumen Summary		
Angle (°)	Average (cd)	Height (ft)	Fc	Diameter (ft)	Zone	Lumens	%Fixt
10	755	4	70	6.8	0-30	642	51%
20	706	6	31	10.2	0-40	1,080	86%
30	846	8	18	13.6	0-60	1,250	100%
40	467	10	11	17.1	0-90	1,250	100%
50	76	12	8	20.5			
60	1						
70	0						
80	0						
90	0						

SPFTS6-LEM9035-KDIM010-UNV-VN-ADS6CC

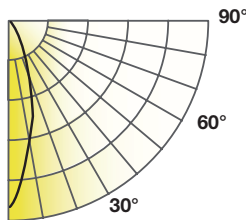

Lumens: 2,613 lm
CBCP: 9,216 cd
Power: 28 W
Efficacy: 81 lm/W
CRI: 90+
Spacing Criteria: 0.42
Beam Angle: 26°

Candlepower Distribution		Initial Footcandles			Zonal Lumen Summary		
Angle (°)	Average (cd)	Height (ft)	Fc	Diameter (ft)	Zone	Lumens	%Fixt
10	5,323	4	495	1.8	0-30	2,340	90%
20	2,507	6	220	2.8	0-40	2,552	98%
30	698	8	124	3.7	0-60	2,610	100%
40	144	10	79	4.6	0-90	2,611	100%
50	30	12	55	5.5			
60	1						
70	0						
80	0						
90	0						

SPFTS6-LEM9035-KDIM010-UNV-NR-ADS6CC

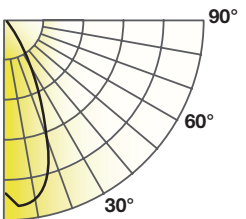

Lumens: 2,663 lm
CBCP: 5,360 cd
Power: 28 W
Efficacy: 82 lm/W
CRI: 90+
Spacing Criteria: 0.63
Beam Angle: 41°

Candlepower Distribution		Initial Footcandles			Zonal Lumen Summary		
Angle (°)	Average (cd)	Height (ft)	Fc	Diameter (ft)	Zone	Lumens	%Fixt
10	4,951	4	460	3.0	0-30	2,357	89%
20	2,936	6	204	4.5	0-40	2,617	98%
30	968	8	115	6.0	0-60	2,661	100%
40	151	10	74	7.5	0-90	2,661	100%
50	14	12	51	9.0			
60	1						
70	0						
80	0						
90	0						



SPECFIT 6" NEW CONSTRUCTION

PHOTOMETRY

SPFST6-LEM9035-KDIM010-UNV-MD-ADS6CC

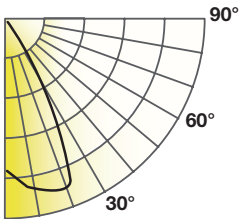

Lumens: 2,680 lm
CBCP: 2,976 cd
Power: 28 W
Efficacy: 81 lm/W
CRI: 90+
Spacing Criteria: 0.91
Beam Angle: 64°

Candlepower Distribution		Initial Footcandles			Zonal Lumen Summary		
Angle (°)	Average (cd)	Height (ft)	Fc	Diameter (ft)	Zone	Lumens	%Fixt
10	2,802	4	260	5.0	0-30	2,025	76%
20	2,655	6	116	7.5	0-40	2,555	95%
30	1,539	8	65	10.0	0-60	2,677	100%
40	395	10	42	12.5	0-90	2,678	100%
50	20	12	29	15.0			
60	2						
70	0						
80	0						
90	0						

SPFST6-LEM9035-KDIM010-UNV-WD-ADS6CC

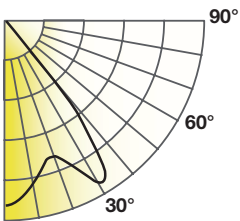

Lumens: 2,684 lm
CBCP: 1,900 cd
Power: 28 W
Efficacy: 83 lm/W
CRI: 90+
Spacing Criteria: 1.19
Beam Angle: 81°

Candlepower Distribution		Initial Footcandles			Zonal Lumen Summary		
Angle (°)	Average (cd)	Height (ft)	Fc	Diameter (ft)	Zone	Lumens	%Fixt
10	1,626	4	151	6.9	0-30	1,378	51%
20	1,521	6	67	10.3	0-40	2,318	86%
30	1,826	8	38	13.7	0-60	2,681	100%
40	1,037	10	24	17.1	0-90	2,683	100%
50	155	12	17	20.6			
60	3						
70	0						
80	0						
90	0						

SPFST6-LEL9035-KDIM010-UNV-VN-ADS6CC

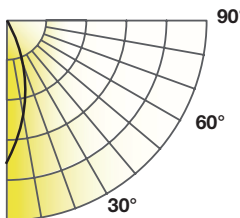

Lumens: 4,765 lm
CBCP: 10,381 cd
Power: 28 W
Efficacy: 79 lm/W
CRI: 90+
Spacing Criteria: 0.55
Beam Angle: 34°

Candlepower Distribution		Initial Footcandles			Zonal Lumen Summary		
Angle (°)	Average (cd)	Height (ft)	Fc	Diameter (ft)	Zone	Lumens	%Fixt
10	1,626	4	151	2.4	0-30	1,378	51%
20	1,521	6	67	3.7	0-40	2,318	86%
30	1,826	8	38	4.9	0-60	2,681	100%
40	1,037	10	24	6.1	0-90	2,683	100%
50	155	12	17	7.3			
60	3						
70	0						
80	0						
90	0						



SPECFIT 6" NEW CONSTRUCTION

PHOTOMETRY

SPFSTS6-LEL9035-KDIM010-UNV-NR-ADS6CC

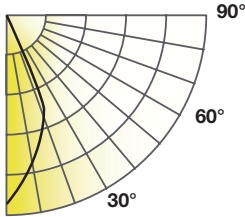

Lumens: 5,079 lm
CBCP: 9,154 cd
Power: 53 W
Efficacy: 86 lm/W
CRI: 90+
Spacing Criteria: 0.68
Beam Angle: 45°

Candlepower Distribution		Initial Footcandles			Zonal Lumen Summary		
Angle (°)	Average (cd)	Height (ft)	Fc	Diameter (ft)	Zone	Lumens	%Fixt
10	7,593	4	705	3.3	0-30	4,198	83%
20	5,198	6	313	5.0	0-40	4,943	97%
30	2,044	8	176	6.6	0-60	5,071	100%
40	467	10	113	8.3	0-90	5,074	100%
50	40	12	78	9.9			
60	5						
70	1						
80	0						
90	0						

SPFSTS6-LEL9035-KDIM010-UNV-MD-ADS6CC

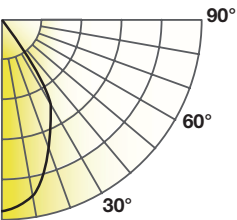

Lumens: 5,113 lm
CBCP: 6,346 cd
Power: 53 W
Efficacy: 86 lm/W
CRI: 90+
Spacing Criteria: 0.80
Beam Angle: 59°

Candlepower Distribution		Initial Footcandles			Zonal Lumen Summary		
Angle (°)	Average (cd)	Height (ft)	Fc	Diameter (ft)	Zone	Lumens	%Fixt
10	5,593	4	520	3.9	0-30	3,603	71%
20	4,188	6	231	5.9	0-40	4,887	96%
30	3,109	8	130	7.9	0-60	5,104	100%
40	816	10	83	9.9	0-90	5,108	100%
50	74	12	58	11.8			
60	6						
70	1						
80	0						
90	0						

SPFSTS6-LEL9035-KDIM010-UNV-WD-ADS6CC

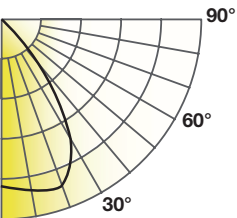

Lumens: 5,212 lm
CBCP: 4,102 cd
Power: 53 W
Efficacy: 88 lm/W
CRI: 90+
Spacing Criteria: 1.07
Beam Angle: 72°

Candlepower Distribution		Initial Footcandles			Zonal Lumen Summary		
Angle (°)	Average (cd)	Height (ft)	Fc	Diameter (ft)	Zone	Lumens	%Fixt
10	4,015	4	373	3.9	0-30	3,152	61%
20	3,849	6	166	5.9	0-40	4,643	89%
30	3,108	8	93	7.9	0-60	5,199	100%
40	1,581	10	60	9.9	0-90	5,207	100%
50	220	12	41	11.8			
60	12						
70	3						
80	0						
90	0						