

Date		Notes
Project		
Type	Qty	

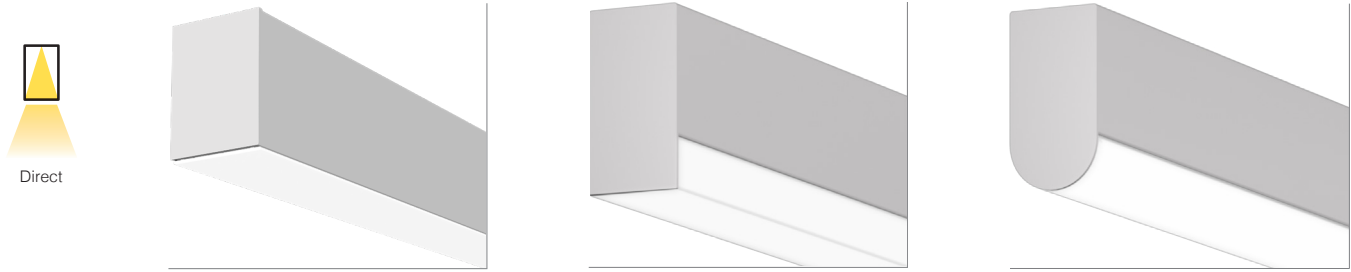

### Features

- PRFL-22-D may be suspended, surface or wall mounted.
- Three LED optimized lens options for smooth illumination end-to-end.
- High efficacy LEDs in 80 or 90 CRI; static white or tunable white.
- BIOS SkyBlue available LEDs in white, dim-to-warm and tunable white.
- Programmable driver for custom lumen packages. 0-10V dimming to 1%.

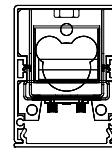

FL lens

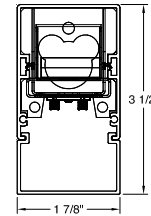

DS1 lens

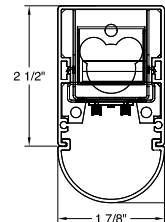

DR1 lens

### Ordering Guide

MODEL	OPTICS	CCT <sup>1</sup>	LUMENS	LENGTH <sup>3</sup>	MOUNTING <sup>4</sup>	FINISH	OPTIONS
<b>PRFL-22-D</b>							
PRFL-22-D Direct	FL = Frosted Acrylic Flush Lens DS1 = 1" Square Drop Lens DR1 = 1" Round Drop Lens	27 = 2700K 80CRI 30 = 3000K 80CRI 35 = 3500K 80CRI 40 = 4000K 80CRI 50 = 5000K 80CRI  90 CRI add *9* Ex: 940 = 4000K @ 90 CRI  <b>BIOS SkyBlue<sup>2</sup></b> Spectrally optimized circadian solutions.	<b>FL LENS</b> LO = 525/ft (5W/ft, 105LPW)  SO = 700/ft (7W/ft, 100LPW)  <b>DS1 LENS</b> LO = 570/ft (5W/ft, 114LPW)  SO = 760/ft (7W/ft, 108LPW)  <b>DR1 LENS</b> LO = 560/ft (5W/ft, 112LPW)  SO = 750/ft (7W/ft, 107LPW)  Consult factory for additional lumen packages.  All values nominal	2 = 2 ft 3 = 3 ft 4 = 4 ft 5 = 5 ft 6 = 6 ft 7 = 7 ft 8 = 8 ft  For other enter row length (e.g. 48 = 48 ft)	AC = Aircraft Cable  PD = Pendant Stem  S = Surface  WM = Wall Mount	W = White  CC = Custom Color  AMW = Anti-Microbial White	<b>DIMMING DRIVERS</b> DIM10 = 0-10V (1.0%) - Standard DIMSR = 0-10V (5.0%) Sensor Ready DIMST = Step Dimming (40%/100%) DALI = DALI (5.0%)  <b>LUTRON™ DIMMING DRIVERS</b> LDE1 = Hi-Lume™ 1% EcoSystem™ L3DA3W = Hi-Lume™ 1% 3-Wire  <b>SENSORS &amp; CONTROLS</b> ESN = Philips EasySense ENL = Enlighted Sensor VDO = Vive Sensor by Lutron AWNR = Athena RF/Node AWNS = Athena Sensor CAS = Casambi Bluetooth  <b>EMERGENCY</b> EMC = Emergency Circuit GTD = Generator Transfer Device EPC4 = 4W Emergency Battery Pack EPC7 = 7W Emergency Battery Pack EPC10 = 10W Emergency Battery Pack EPC12 = 12W Emergency Battery Pack  Please contact Day-O-Lite directly for drivers, sensors, wireless controls or emergency options not listed above.

<sup>1</sup> CCT @ 80+CRI, 3SDCM. For 90CRI add prefix \*9\*; ex: 935 = 3500K, 90CRI.

<sup>2</sup> BIOS SkyBlue Biological Static & Dynamic page 2.

<sup>3</sup> See page 3 for actual fixture lengths, mounting locations.

<sup>4</sup> See page 5 for suspension and wall mount details.



## BIOS SkyBlue

BIOS SkyBlue biological technology brings the benefits of blue skies inside. BIOS SkyBlue is the only spectrally optimized circadian solution to pinpoint the region that drives wellness benefits including: increased alertness, enhanced productivity, better mood, and better sleep. More information may be found at [www.bioslighting.com](http://www.bioslighting.com) or by contacting Day-O-Lite directly.

## BIOS Biological Static - Daytime Solution

BIOS Biological Static solutions are designed for daytime applications. BIOS Static Biological LED features key BIOS SkyBlue™ (490nm) for maximum daytime circadian impact. BIOS Static Biological LED Light Engines are available in 3000K, 3500K, and 4000K. Lighting controls are easy; simply switch the lights on/off or the lights can be dimmed using a single-channel constant current (CC) LED driver with any standard dimming interface.

Applications:

- Spaces occupied during the daytime ~7am – 7pm
- K-12 Schools / Higher Education
- Offices
- Daytime Adult Care Facilities
- Medical Offices

BIOS Biological Static  
Ordering Codes:

- B30** = 3000K
- B35** = 3500K
- B40** = 4000K

BIOS Biological Static 3500K

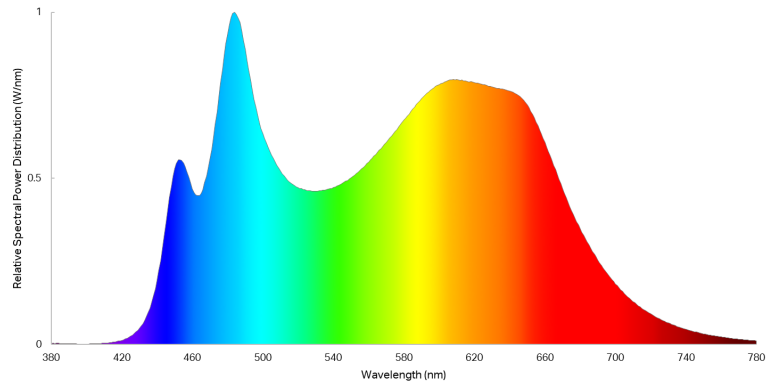

## BIOS Biological Dynamic - Day & Night Solution A

BIOS Biological Dynamic solutions are designed to transition from daytime to evening in a dim-to-warm protocol. The daytime CCT includes full BIOS SkyBlue™ (490nm) for maximum daytime circadian impact, while the evening spectrum removes BIOS SkyBlue™ altogether, providing a minimal circadian stimulus after hours. Available in 3000K-2700K, 3500K-3000K and 4000K-3500K. Simply dim the lights in the evening to remove the daytime SkyBlue wavelengths (490nm) and convert your lights from day mode to night mode via a single controller (0-10V, ELV, DMX, Wireless).

## BIOS Biological Tunable White - Day & Night Solution B

BIOS Biological Tunable solutions are designed to transition from daytime to evening in a dim-to-warm protocol. The daytime CCT includes full BIOS SkyBlue™ (490nm) for maximum daytime circadian impact, while the evening spectrum removes BIOS SkyBlue™ altogether, providing a minimal circadian stimulus after hours. Available in 3000K-2700K, 3500K-3000K and 4000K-3500K. Simply dim the lights in the evening to remove the daytime SkyBlue wavelengths (490nm) and convert your lights from day mode to night mode via a single controller (0-10V, ELV, DMX, Wireless).

BIOS Biological Tunable is also compatible with two-channel color tuning systems. Simply dim the lights in the evening to convert your lights from day mode to night mode via a multi-channel controller (0-10V, ELV, DMX, Wireless). 3000K, 3500K and 4000K CCTs all dim to 2700K.

Applications:

- Spaces occupied overnight (~ 7pm to 7am)
- 24-hour spaces
- Shiftwork & Hospitals
- Senior Living, Alzheimer's Dementia & Assisted Living
- Higher Education, including student and staff
- Workplace, including areas occupied after 7pm

BIOS Biological  
Dynamic White  
Ordering Codes:

- B30D** = 3000K-2700K
- B35D** = 3500K-3000K
- B40D** = 4000K-3500K

BIOS Biological  
Tunable White  
Ordering Codes:

- B30T** = 3000K-2700K
- B35T** = 3500K-2700K
- B40T** = 4000K-2700K

BIOS Biological Dynamic 3500K

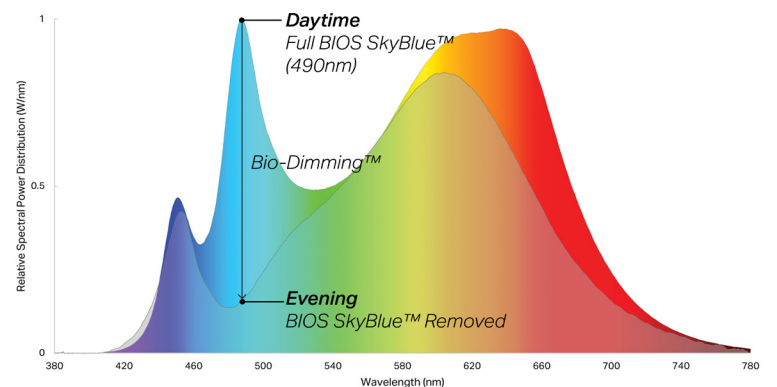

### Individual Fixtures & Continuous Rows

NOMINAL LENGTH	ACTUAL LENGTH	SUSP. 1 O.C.	SUSP. 2 O.C.	SUSP. 3 O.C.
4'	3' 8-1/2"	41 1/2"		
8'	7' 5"	86"		
12'	11' 1-1/2"	86"	44 1/2"	
16'	14' 10"	86"	89"	
20'	18' 6-1/2"	86"	89"	44 1/2"
24'	22' 3"	86"	89"	89"

Individual fixtures and rows are continuously illuminated and joined with included aligner brackets and hardware. Power feed locations and mounting locations are shown below.

Continuous rows longer than 8' and patterns, including EPC/EMC and sensor locations must be approved prior to manufacturing. See following page to specify patterns.

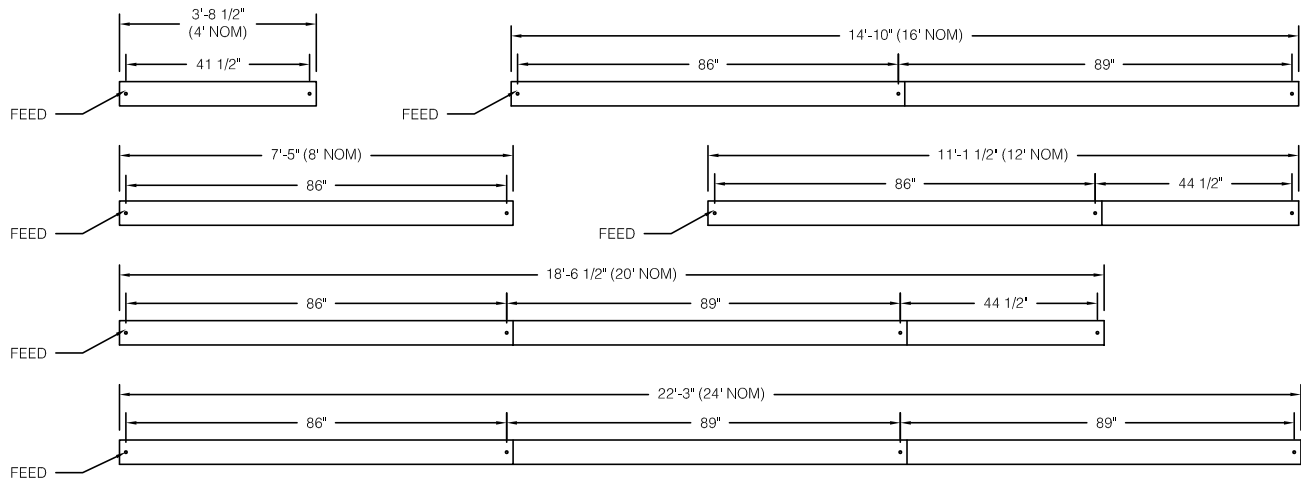

### Emergency & Sensor Locations

EPC will control entire length of individual fixtures. Individual fixtures of differing lengths will deliver the same lumens under EPC power (a 4' fixture will deliver the same total lumens over half the length of an 8' fixture). EMC controlled individual fixtures will deliver lumens per foot as originally specified, unless dimmed at time of power loss. Consult factory for EMC dimming override device.



For individual fixtures to 8' EPC/EMC will power entire fixture.

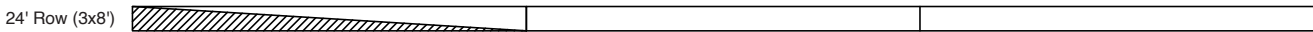

For continuous rows longer than 8' one EPC/EMC will be located in the feed section (end-left) of the row as shown below.

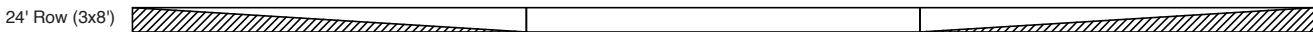

If two EPC/EMC's are required their default locations will be in the feed section (end-left) and last section (end-right) as below.



Custom placement of one or more EPC/EMC's must be clearly identified during ordering.



SENSORS (Integral) for individual fixtures will control entire length of fixture and will be located on feed end of fixture.

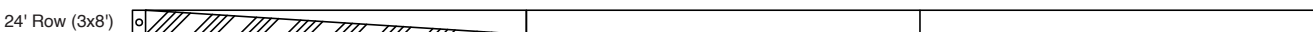

SENSORS for rows by default will control the feed section (end-left) of the row. Sensors can control more than an 8' section within a row. Consult factory for sensor/section options, or for multiple sensors in a continuous row.

## Pattern Guide

Profile may be specified in patterns of virtually any configuration. All patterns and corners are continuously illuminated and joined with included aligner brackets and joining hardware. See examples below for pattern suggestions. Day-O-Lite's custom manufacturing capabilities allow the specification of custom angled connectors to make arbitrary patterns possible. (See ILX example below).

All corners and connectors are fully welded to ensure correct dimensions and "square" joinery when assembled.

## How to Specify

1. Submit your pattern to Day-O-Lite in dimensioned CAD file or submit a fully dimensioned PDF file.
2. If EPC/EMC or Sensors are to be included their location needs to be clearly noted.
3. Day-O-Lite will design your pattern to as close as is nominally possible given standard LED module lengths, including connectors.
4. Day-O-Lite will supply a detailed drawing for approval with final dimensions. All patterns must be approved prior to manufacture.

## Pattern Examples

## Illuminated Connectors

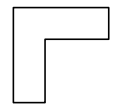
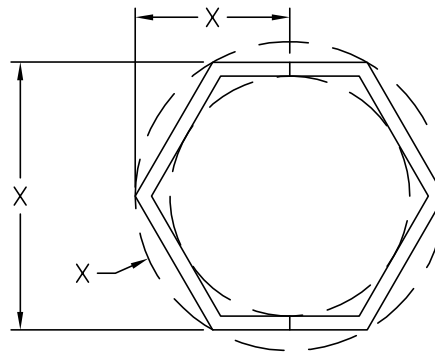
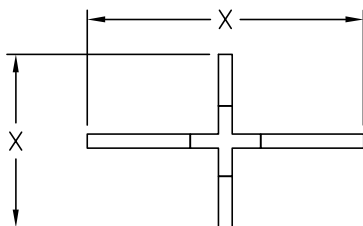
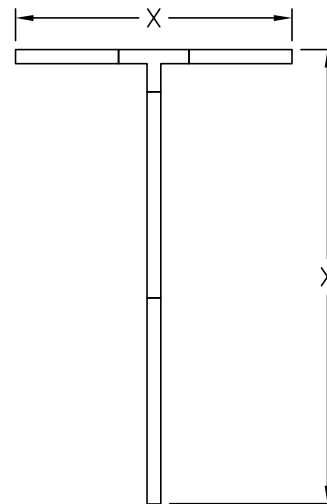
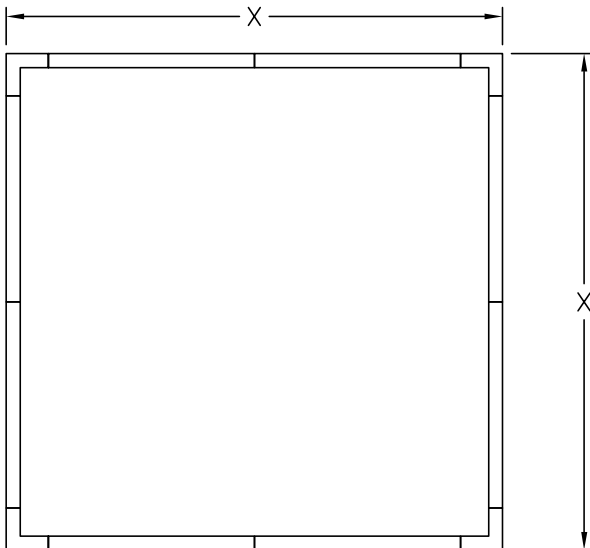

**ILC2 = 90° Corner**

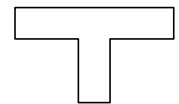

**ILC3 = 90° Tee**

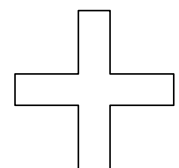

**ILC4 = 90° Cross**

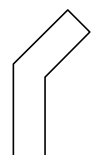

**ILCX = X° Custom**

## Standard Suspensions

Standard suspension options include adjustable self-locking aircraft cables (AC) and rigid pendant stems (PD). AC assembly is 48" x 1/16" with a 5" feed canopy and 2" suspension canopies. 60" 18 gauge power and 22 gauge dimming control SJT feed.

PD assemblies are 5/8" dia. (or 3/8" IP) hollow stem for power feed by others, 24" is standard. Consult factory for longer suspension lengths and other mounting options.

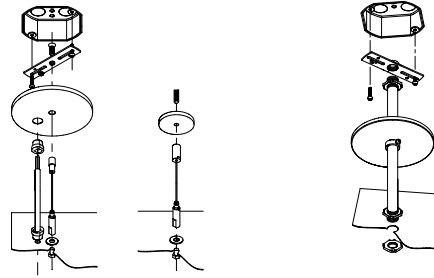

AC = Aircraft Cable

PD = Pendant Stem

## Photometry

PRFL-22-D-FL-40-LO-4  
FL Lens

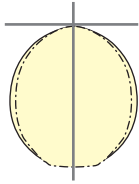

4000K CCT  
WATTS: 20  
LUMENS: 2100  
LPW: 105  
Distribution:  
100% Direct

PRFL-22-D-FL-40-SO-4  
FL Lens

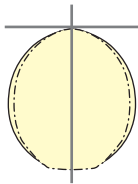

4000K CCT  
WATTS: 27  
LUMENS: 2800  
LPW: 100  
Distribution:  
100% Indirect

PRFL-22-D-FL-40-LO-4  
DS1 Lens

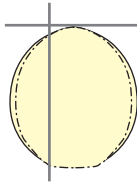

4000K CCT  
WATTS: 20  
LUMENS: 2280  
LPW: 114  
Distribution:  
100% Direct

PRFL-22-D-FL-40-SO-4  
DS1 Lens

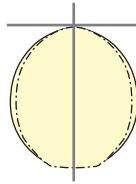

4000K CCT  
WATTS: 27  
LUMENS: 3040  
LPW: 108  
Distribution:  
100% Indirect

PRFL-22-D-FL-40-LO-4  
DR1 Lens

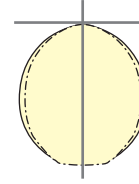

4000K CCT  
WATTS:  
LUMENS: 2240  
LPW: 112  
Distribution:  
100% Direct

PRFL-22-D-FL-40-SO-4  
DR1 Lens

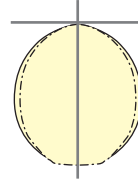

4000K CCT  
WATTS: 27  
LUMENS: 3000  
LPW: 107  
Distribution:  
100% Indirect

## Specifications

**CONSTRUCTION:** Extruded aluminum housing.

**REFLECTOR:** Die-formed steel finished in highly reflective baked white enamel.

**OPTICS:** LED optimized Acrylic (ACR) lens is standard. Clear Acrylic (CA) dust covers also available for indirect applications.

**LEDS:** LED modules in 30/35/40 & 50K CCT, 80/90CRI.  $L_{70} = 1000,000$  hours. 3 SDCM color consistency; field replaceable.

**DRIVER** Standard driver is Class 2 AOC 0-10V to 1%, 120/277V input, PF > 90%, THD < 20 @ 120V. Additional dimming protocols available. All drivers prewired from factory for connection to control system (by others), field replaceable.

**MOUNTING** Standard options include adjustable self-locking aircraft cables (AC), and rigid pendant stems (PD). AC assembly is 48" x 1/16" with a 5" feed canopy and 2" suspension canopies. 18 gauge power and 22 gauge dimming control SJT feed. May also be wall mounted to a 2"x4" J-box or surface mounted.

**FINISH:** Finished in baked white enamel. Canopies, pendant stems and wall brackets are white enamel unless otherwise specified.

**CERTIFICATION:** Luminaires are cETLus listed conforming to UL STD. 1598 and certified to CSA STD C22.2 NO. 250.0. Suitable for dry locations. Union Made in the United States of America. I.B.E.W. RoHS compliant.