

JEDI COMPACT

Powerful Compact Linear Adjustable Projector Floodlight

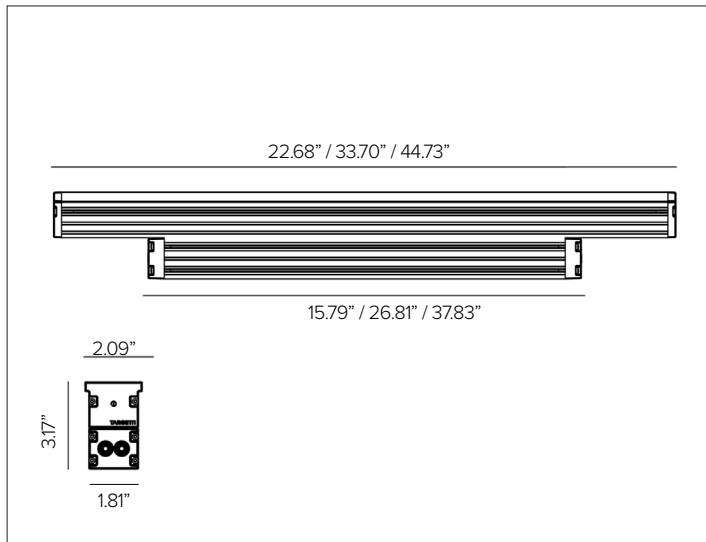

CONCEPT

Powerful compact linear LED adjustable projector floodlight.

MECHANICAL CHARACTERISTICS

Housing	2.09"W X 3.17"D
Materials	Extruded anodized aluminum 15μ body with extra clear 5mm thick flat glass.
Finish	● Natural
Power Connection	Pre-wired from driver enclosure with 2ea 20inL cables: Belden 18-2 direct burial 0-10V for dimming and SJ00W 18-3 for power. Lead and Solo configurations provided with 2ea 10ftL lead dimming and power cables. IP68 disconnects included. For Permapost configuration only, fixtures are supplied with field attached IP68 connectors. See In-line Connection Configuration for detailed diagrams.
Functionality	The body of the fixture is adjustable and can be installed away from the mounting surface using accessory snap brackets.
Mounting	To be completed with surface adjustable mounting bracket or landscape permapost mounting, see available options.
Weight	5.73lbs (22.68"L) / 7.94lbs (33.70"L) / 9.92lbs (44.73"L)
Protection	IP67
Impact	IK08

CERTIFICATIONS

cULus Wet Location Listed.
 Tested in accordance with LM-79-08.
 Compliant for California installations.
 RoHS3 EU 215/863

WARRANTY

5 year limited warranty
 ^Fixture suitable for use in marine grade environments. Not to be in direct contact with salt or corrosive agents for extended periods of time.

SUSTAINABILITY

Luminaire designed for disposal/recycling at end-of-life. Replaceable LED light source and control gear by a Targetti technician.

ELECTRICAL CHARACTERISTICS

Power Supply	Integral electronic 0–10V dimmable driver to 1% dim range.
Wattage	28W (22.68"L) / 40W (33.70"L) / 53W (44.73"L). Consult factory for derated options.
Voltage	Universal Voltage 120-277V AC 50/60Hz
Safe Flicker	PstLM<=1 and SVM<=1 (IEC TR 61547-1 and IEC TR 63158)

SOURCE

SP: High efficiency LED emitter. WW / WG / FL: Linear high efficiency LED board.

TM30	CCT (Nominal)	CRI	Rf	Rg	SDCM
	2700K	80	83	97.3	3
	3000K	80	82.9	97	3
	3500K	80	83.6	96.5	3
	4000K	80	82.6	95.7	3

Ra90 available upon request

OPTIC

Optical system is dependent on beam angle. WW / WG / FL is comprised of a primary cylindrical methacrylate lens and a high reflectance anodized aluminum reflector with an integrated holographic filter. SP is comprised of individual lenses for more precise beam and higher intensity.

Beam	WW 59°x115°	WG 15°x76°	FL 32°x85°	SP 11°x11°
Delivered Lumens	2700K 2428Lm	2684Lm	2413Lm	2371Lm
	3000K 2586Lm	2858Lm	2570Lm	2501Lm
	3500K 2646Lm	2924Lm	2630Lm	2655Lm
	4000K 2706Lm	2991Lm	2690Lm	2744Lm
Efficacy	113Lm/W max. Refer to photometric graphs for specific values.			
Lifetime	WW / WG / FL: L95/B10 30,000hrs at max TA +25°C, L91/B10 50,000hrs at max TA +25°C SP: L96/B10 30,000hrs at max TA +25°C, L95/B10 50,000hrs at max TA +25°C			
Photobiological Classification	Low risk safety RG1			

JEDI COMPACT

SPECIFICATION INFORMATION

JE	C											
1	2	3	4	5	6	7	8	9	10	11	12	
Ex: JECO41WW2430S / 1E3304						REQUIRED	OPTIONAL		REQUIRED	OPTIONAL		

1 - PRODUCT CODE	2 - TYPE	2 - TYPE	3 - DRIVER	4 - OPTICS	5 - LENGTH	6 - KELVIN	7 - CABLE	8 - OPTICAL ACCESSORY	9 - LONGER LEAD CONNECTION CABLE	10 - JUMPER CONNECTION CABLE	11 - MOUNTING	12 - EXTERNAL OPTICAL ACCESSORY
JE — JEDI	C — Compact	O — Outdoor	10 — 0–10V	WW — WW 59°x115° WG — WG 15°x76° FL — FL 32°x85° SP^B — SP 11°x11°	24 — 22.68" 36 — 33.70" 48 — 44.73"	27 — 2700K 30 — 3000K 35 — 3500K 40 — 4000K	L — Lead C — Center E — End S — Solo P — Permapost	LV^B — Integral Anti-Glare Louver	25ft Cable See section for details 50ft Cable See section for details	5ft Jumper See section for details 10ft Jumper See section for details 20ft Jumper See section for details	Short Bracket See section for details Long Bracket See section for details Permapost See section for details	Symmetric Grid See section for details Asymmetric Grid See section for details Fixed Visor See section for details Adjustable Visor See section for details

^B LV option not available with SP optic.

OPTIC VERSIONS

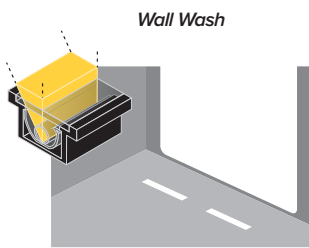

Wall Wash

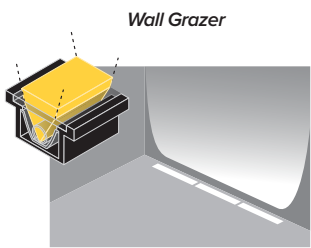

Wall Grazer

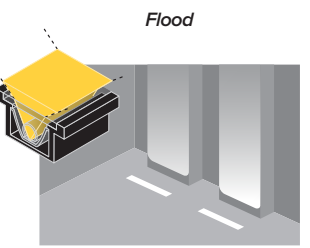

Flood

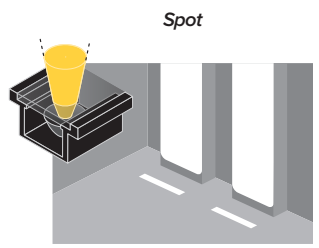

Spot



Integral Louver (WW optic)

Optional integral anti-glare louver, factory installed inside fixture.

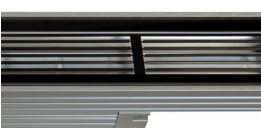

Integral Louver (WG & FL optics)

Optional integral anti-glare louver, factory installed inside fixture.

No Louver Option (SP optic only)

JEDI COMPACT

7 – CABLE

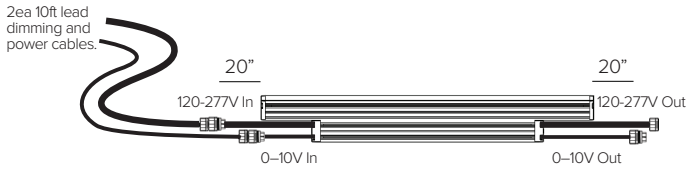

Lead – 2ea 20inL cables: Belden 18/2 direct burial 0-10V for dimming and SJOOW 18/3 for power. 2ea 10ft lead dimming and power cables. IP68 disconnects included.

Part No. **L**



Center – 2ea 20inL cables: Belden 18/2 direct burial 0-10V for dimming and SJOOW 18/3 for power. IP68 disconnects included.

Part No. **C**

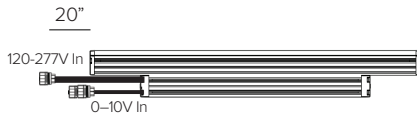

End – 1ea 20inL cables: Belden 18/2 0-10V direct burial for dimming and SJOOW 18/3 for power. IP68 disconnects included.

Part No. **E**

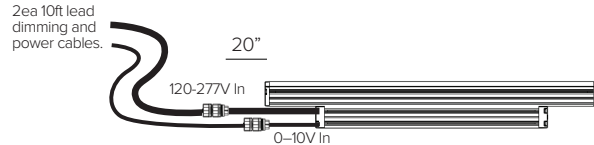

Solo – 1ea 20inL cables: Belden 18/2 direct burial 0-10V for dimming and SJOOW 18/3 for power. 1ea 10ft lead dimming and power cables. 1ea IP68 disconnects included.

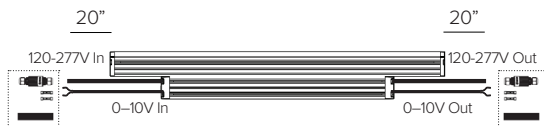

Part No. **S**



Permapost – 2ea 20inL cables: Belden 18/2 direct burial 0-10V for dimming and SJOOW 18/3 for power. Supplied with 2ea IP68 connector kits. **For use with JECOPP24 mounting accessory only.**

Part No. **P**

IP68 connector kit.

-  IP68 Field Connector
-  Heat Shrink Waterproof Connector
-  4" Waterproof Heat-shrink tube

2ea Lead / Center Fixture
1ea Solo / End fixture

8 – LONGER LEAD CONNECTION CABLE KIT (OPTIONAL)



JEDI COMPACT INTEGRAL optional longer lead kit includes 1ea SJOOW line voltage power and 1ea 18–2 dimming lead cables with female IP68 quick disconnect at one end. **Cables can be field cut for percise installation.**

Length 25ft

Power Cable Gauge 16–3

Part No. **JEC10LEAD-25**

9 – JUMPER CONNECTION CABLE KIT (OPTIONAL)



JEDI COMPACT INTEGRAL jumper kit includes 1ea SJOOW line voltage power and 1ea 18–2 dimming lead cables with female IP68 quick disconnect at one end. **Connectors can be field removed and re-attached to modify lengths for percise installation.**

Length 5FT 10FT

Power Cable Gauge 18–3 16–3

Part No. **JEC10JUMP-05 JEC10JUMP-10**

JEDI COMPACT

10 – MOUNTING (REQUIRED)

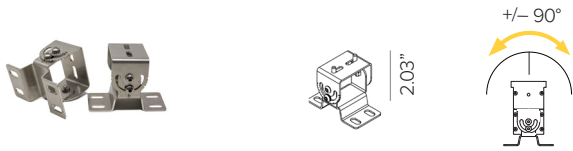

JEDI COMPACT short stainless steel mounting bracket for surface installation (2pcs).

Part No. **1E3304**

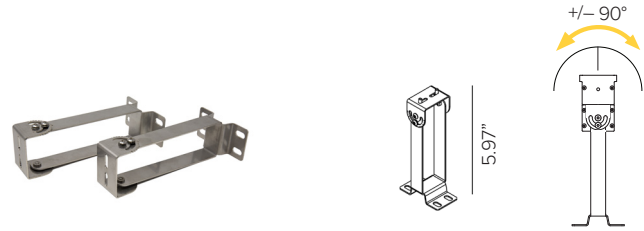

JEDI COMPACT long stainless steel mounting bracket for surface installation (2pcs).

Part No. **1E3306**

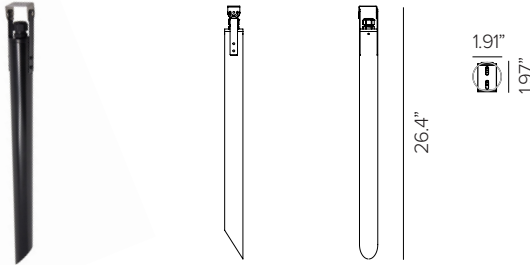

JEDI COMPACT aluminum permapost with stainless steel long mounting bracket (2pcs) and (2pcs) stabilizers.

Finish ● Deep Black

Part No. **JECOPP24**

11 – EXTERNAL ACCESSORY (OPTIONAL)

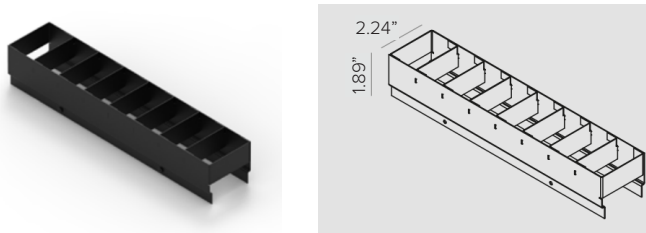

JEDI COMPACT external symmetric stainless steel grid. **To be used with SP / FL / WG optics only.**

Finish ● Deep Black

Length 11.02" 22.68" 33.70" 44.73"

Part No. **1E3900 1E3901 1E3902 1E3903**

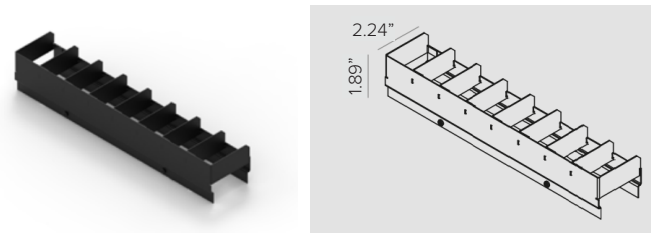

JEDI COMPACT external asymmetric stainless steel grid.

Finish ● Deep Black

Length 11.02" 22.68" 33.70" 44.73"

Part No. **1E3904 1E3905 1E3906 1E3907**

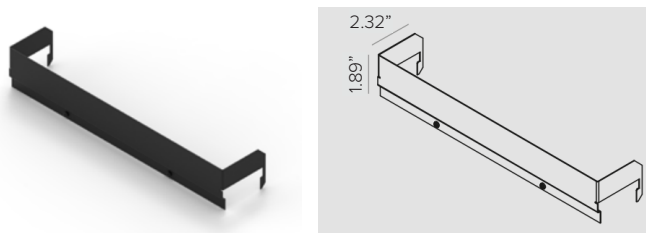

JEDI COMPACT external fixed stainless steel visor.

Finish ● Deep Black

Length 11.41" 22.68" 33.70" 44.73"

Part No. **1E3908 1E3909 1E3910 1E3911**

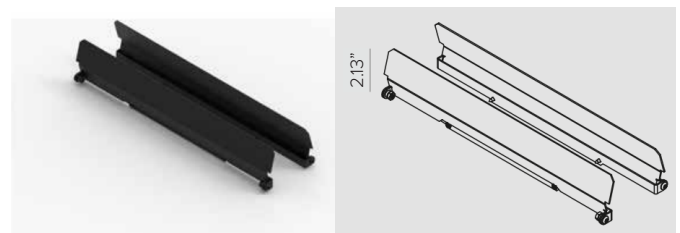

JEDI COMPACT external adjustable stainless steel visor.

Finish ● Deep Black

Length 11.65" 22.68" 33.70" 44.73"

Part No. **1E3912 1E3913 1E3914 1E3915**

JEDI COMPACT

PERMAPOST INSTALLATION DIAGRAM

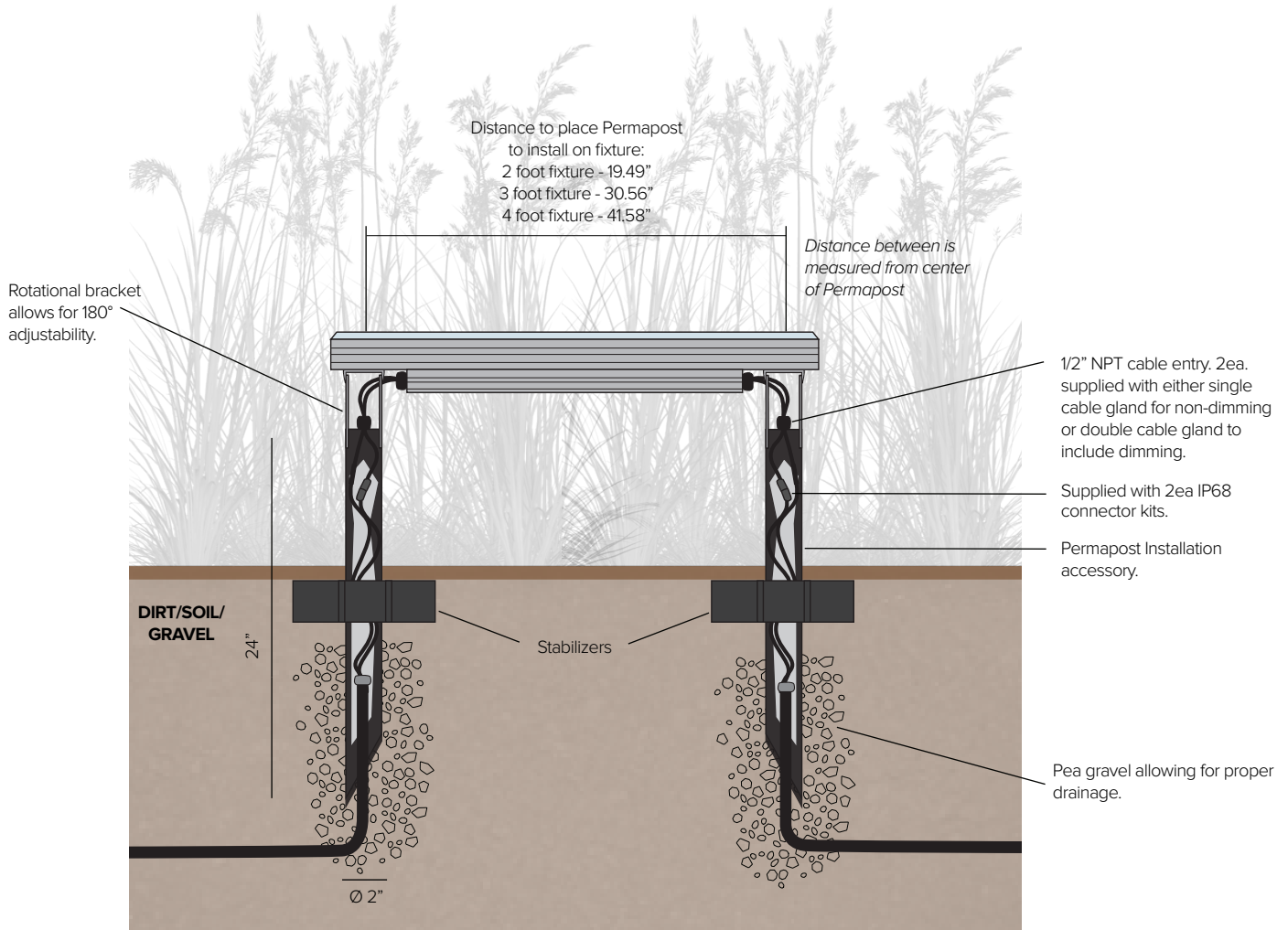

JEDI COMPACT

PHOTOMETRY

24" WALL WASHER



2700K		H(m)	D1(m)	D2(m)	Emax(lx)
Ra84		115°	59°		
Fixture Power	28W	1	3.12	1.34	2171
Source Flux	3230lm	2	6.23	2.67	543
Fixture Flux	2428lm	3	9.35	4.01	241
Efficacy	87lm/W	4	12.47	5.35	136
TS1092	I _{max} =774cd/klm	I _{max}	2499cd	5	15.59 6.69 87



3000K		H(m)	D1(m)	D2(m)	Emax(lx)
Ra84		115°	59°		
Fixture Power	28W	1	3.12	1.34	2312
Source Flux	3440lm	2	6.23	2.67	578
Fixture Flux	2586lm	3	9.35	4.01	257
Efficacy	92lm/W	4	12.47	5.35	145
TS1092	I _{max} =774cd/klm	I _{max}	2661cd	5	15.59 6.69 92



3500K		H(m)	D1(m)	D2(m)	Emax(lx)
Ra84		115°	59°		
Fixture Power	28W	1	3.12	1.34	2366
Source Flux	3520lm	2	6.23	2.67	591
Fixture Flux	2646lm	3	9.35	4.01	263
Efficacy	95lm/W	4	12.47	5.35	148
TS1092	I _{max} =774cd/klm	I _{max}	2723cd	5	15.59 6.69 95



4000K		H(m)	D1(m)	D2(m)	Emax(lx)
Ra84		115°	59°		
Fixture Power	28W	1	3.12	1.34	2420
Source Flux	3600lm	2	6.23	2.67	605
Fixture Flux	2706lm	3	9.35	4.01	269
Efficacy	97lm/W	4	12.47	5.35	151
TS1092	I _{max} =774cd/klm	I _{max}	2785cd	5	15.59 6.69 97

36" WALL WASHER



2700K		H(m)	D1(m)	D2(m)	Emax(lx)
Ra84		115°	59°		
Fixture Power	40W	1	3.12	1.34	3257
Source Flux	4845lm	2	6.23	2.67	814
Fixture Flux	3643lm	3	9.35	4.01	362
Efficacy	91lm/W	4	12.47	5.35	204
TS1093	I _{max} =774cd/klm	I _{max}	3749cd	5	15.59 6.69 130



3000K		H(m)	D1(m)	D2(m)	Emax(lx)
Ra84		115°	59°		
Fixture Power	40W	1	3.12	1.34	3469
Source Flux	5160lm	2	6.23	2.67	867
Fixture Flux	3880lm	3	9.35	4.01	385
Efficacy	97lm/W	4	12.47	5.35	217
TS1093	I _{max} =774cd/klm	I _{max}	3992cd	5	15.59 6.69 139



3500K		H(m)	D1(m)	D2(m)	Emax(lx)
Ra84		115°	59°		
Fixture Power	40W	1	3.12	1.34	3550
Source Flux	5280lm	2	6.23	2.67	887
Fixture Flux	3970lm	3	9.35	4.01	394
Efficacy	99lm/W	4	12.47	5.35	222
TS1093	I _{max} =774cd/klm	I _{max}	4085cd	5	15.59 6.69 142



4000K		H(m)	D1(m)	D2(m)	Emax(lx)
Ra84		115°	59°		
Fixture Power	40W	1	3.12	1.34	3630
Source Flux	5400lm	2	6.23	2.67	908
Fixture Flux	4060lm	3	9.35	4.01	403
Efficacy	102lm/W	4	12.47	5.35	227
TS1093	I _{max} =774cd/klm	I _{max}	4178cd	5	15.59 6.69 145

48" WALL WASHER



2700K		H(m)	D1(m)	D2(m)	Emax(lx)
Ra84		115°	59°		
Fixture Power	53W	1	3.12	1.34	4343
Source Flux	6460lm	2	6.23	2.67	1086
Fixture Flux	4858lm	3	9.35	4.01	483
Efficacy	92lm/W	4	12.47	5.35	271
TS1093	I _{max} =774cd/klm	I _{max}	4998cd	5	15.59 6.69 174



3000K		H(m)	D1(m)	D2(m)	Emax(lx)
Ra84		115°	59°		
Fixture Power	53W	1	3.12	1.34	4625
Source Flux	6880lm	2	6.23	2.67	1156
Fixture Flux	5173lm	3	9.35	4.01	514
Efficacy	98lm/W	4	12.47	5.35	289
TS1093	I _{max} =774cd/klm	I _{max}	5323cd	5	15.59 6.69 185

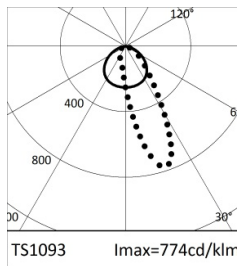

3500K		H(m)	D1(m)	D2(m)	Emax(lx)
Ra84		115°	59°		
Fixture Power	53W	1	3.12	1.34	4733
Source Flux	7040lm	2	6.23	2.67	1183
Fixture Flux	5294lm	3	9.35	4.01	526
Efficacy	100lm/W	4	12.47	5.35	296
TS1093	I _{max} =774cd/klm	I _{max}	5447cd	5	15.59 6.69 189



4000K		H(m)	D1(m)	D2(m)	Emax(lx)
Ra84		115°	59°		
Fixture Power	53W	1	3.12	1.34	4840
Source Flux	7200lm	2	6.23	2.67	1210
Fixture Flux	5414lm	3	9.35	4.01	538
Efficacy	102lm/W	4	12.47	5.35	303
TS1093	I _{max} =774cd/klm	I _{max}	5571cd	5	15.59 6.69 194

JEDI COMPACT

PHOTOMETRY

24" WALL GRAZER



2700K		H(m)	D1(m)	D2(m)	Emax(lx)		
Ra84		76°	15°				
Fixture Power	28W	1	1.55	0.26	5169		
Source Flux	3230lm	2	3.10	0.51	1292		
Fixture Flux	2684lm	3	4.65	0.77	574		
Efficacy	96lm/W	4	6.21	1.02	323		
TS1088	I _{max} =1600cd/klm	I _{max}	5169cd	5	7.76	1.28	207



3000K		H(m)	D1(m)	D2(m)	Emax(lx)		
Ra84		76°	15°				
Fixture Power	28W	1	1.55	0.26	5505		
Source Flux	3440lm	2	3.10	0.51	1376		
Fixture Flux	2858lm	3	4.65	0.77	612		
Efficacy	102lm/W	4	6.21	1.02	344		
TS1088	I _{max} =1600cd/klm	I _{max}	5505cd	5	7.76	1.28	220



3500K		H(m)	D1(m)	D2(m)	Emax(lx)		
Ra84		76°	15°				
Fixture Power	28W	1	1.55	0.26	5633		
Source Flux	3520lm	2	3.10	0.51	1408		
Fixture Flux	2924lm	3	4.65	0.77	626		
Efficacy	104lm/W	4	6.21	1.02	352		
TS1088	I _{max} =1600cd/klm	I _{max}	5633cd	5	7.76	1.28	225

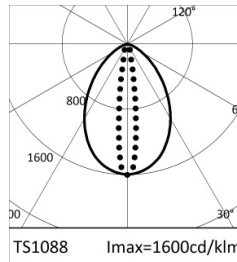

4000K		H(m)	D1(m)	D2(m)	Emax(lx)		
Ra84		76°	15°				
Fixture Power	28W	1	1.55	0.26	5761		
Source Flux	3600lm	2	3.10	0.51	1440		
Fixture Flux	2991lm	3	4.65	0.77	640		
Efficacy	107lm/W	4	6.21	1.02	360		
TS1088	I _{max} =1600cd/klm	I _{max}	5761cd	5	7.76	1.28	230

36" WALL GRAZER



2700K		H(m)	D1(m)	D2(m)	Emax(lx)		
Ra84		76°	15°				
Fixture Power	40W	1	1.55	0.26	7755		
Source Flux	4845lm	2	3.10	0.51	1939		
Fixture Flux	4026lm	3	4.65	0.77	862		
Efficacy	101lm/W	4	6.21	1.02	485		
TS1089	I _{max} =1601cd/klm	I _{max}	7755cd	5	7.76	1.28	310



3000K		H(m)	D1(m)	D2(m)	Emax(lx)		
Ra84		76°	15°				
Fixture Power	40W	1	1.55	0.26	8259		
Source Flux	5160lm	2	3.10	0.51	2065		
Fixture Flux	4288lm	3	4.65	0.77	918		
Efficacy	107lm/W	4	6.21	1.02	516		
TS1089	I _{max} =1601cd/klm	I _{max}	8259cd	5	7.76	1.28	330



3500K		H(m)	D1(m)	D2(m)	Emax(lx)		
Ra84		76°	15°				
Fixture Power	40W	1	1.55	0.26	8451		
Source Flux	5280lm	2	3.10	0.51	2113		
Fixture Flux	4388lm	3	4.65	0.77	939		
Efficacy	110lm/W	4	6.21	1.02	528		
TS1089	I _{max} =1601cd/klm	I _{max}	8451cd	5	7.76	1.28	338



4000K		H(m)	D1(m)	D2(m)	Emax(lx)		
Ra84		76°	15°				
Fixture Power	40W	1	1.55	0.26	8643		
Source Flux	5400lm	2	3.10	0.51	2161		
Fixture Flux	4487lm	3	4.65	0.77	960		
Efficacy	112lm/W	4	6.21	1.02	540		
TS1089	I _{max} =1601cd/klm	I _{max}	8643cd	5	7.76	1.28	346

48" WALL GRAZER



2700K		H(m)	D1(m)	D2(m)	Emax(lx)		
Ra84		76°	15°				
Fixture Power	53W	1	1.55	0.26	10372		
Source Flux	6480lm	2	3.10	0.51	2593		
Fixture Flux	5385lm	3	4.65	0.77	1152		
Efficacy	102lm/W	4	6.21	1.02	648		
TS1089	I _{max} =1601cd/klm	I _{max}	10372cd	5	7.76	1.28	415



3000K		H(m)	D1(m)	D2(m)	Emax(lx)		
Ra84		76°	15°				
Fixture Power	53W	1	1.55	0.26	11012		
Source Flux	6880lm	2	3.10	0.51	2753		
Fixture Flux	5717lm	3	4.65	0.77	1224		
Efficacy	108lm/W	4	6.21	1.02	688		
TS1089	I _{max} =1601cd/klm	I _{max}	11012cd	5	7.76	1.28	440



3500K		H(m)	D1(m)	D2(m)	Emax(lx)		
Ra84		76°	15°				
Fixture Power	53W	1	1.55	0.26	11268		
Source Flux	7040lm	2	3.10	0.51	2817		
Fixture Flux	5850lm	3	4.65	0.77	1252		
Efficacy	110lm/W	4	6.21	1.02	704		
TS1089	I _{max} =1601cd/klm	I _{max}	11268cd	5	7.76	1.28	451

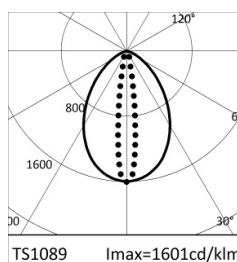

4000K		H(m)	D1(m)	D2(m)	Emax(lx)		
Ra84		76°	15°				
Fixture Power	53W	1	1.55	0.26	11524		
Source Flux	7200lm	2	3.10	0.51	2881		
Fixture Flux	5983lm	3	4.65	0.77	1280		
Efficacy	113lm/W	4	6.21	1.02	720		
TS1089	I _{max} =1601cd/klm	I _{max}	11524cd	5	7.76	1.28	461

JEDI COMPACT

PHOTOMETRY

24" FLOOD



2700K		H(m)	D1(m)	D2(m)	Emax(lx)		
Ra84		85°	32°				
Fixture Power	28W	1	1.84	0.57	2259		
Source Flux	3230lm	2	3.68	1.14	565		
Fixture Flux	2413lm	3	5.52	1.70	251		
Efficacy	86lm/W	4	7.36	2.27	141		
TS1084	I _{max} =699cd/klm	I _{max}	2259cd	5	9.20	2.84	90



3000K		H(m)	D1(m)	D2(m)	Emax(lx)		
Ra84		85°	32°				
Fixture Power	28W	1	1.84	0.57	2406		
Source Flux	3440lm	2	3.68	1.14	601		
Fixture Flux	2570lm	3	5.52	1.70	267		
Efficacy	92lm/W	4	7.36	2.27	150		
TS1084	I _{max} =699cd/klm	I _{max}	2406cd	5	9.20	2.84	96



3500K		H(m)	D1(m)	D2(m)	Emax(lx)		
Ra84		85°	32°				
Fixture Power	28W	1	1.84	0.57	2462		
Source Flux	3520lm	2	3.68	1.14	615		
Fixture Flux	2630lm	3	5.52	1.70	274		
Efficacy	94lm/W	4	7.36	2.27	154		
TS1084	I _{max} =699cd/klm	I _{max}	2462cd	5	9.20	2.84	98



4000K		H(m)	D1(m)	D2(m)	Emax(lx)		
Ra84		85°	32°				
Fixture Power	28W	1	1.84	0.57	2518		
Source Flux	3600lm	2	3.68	1.14	629		
Fixture Flux	2690lm	3	5.52	1.70	280		
Efficacy	96lm/W	4	7.36	2.27	157		
TS1084	I _{max} =699cd/klm	I _{max}	2518cd	5	9.20	2.84	101

36" FLOOD

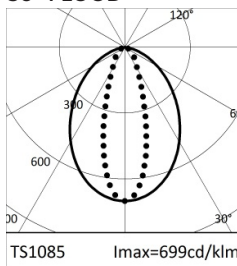

2700K		H(m)	D1(m)	D2(m)	Emax(lx)		
Ra84		85°	32°				
Fixture Power	40W	1	1.84	0.57	3389		
Source Flux	4845lm	2	3.68	1.14	847		
Fixture Flux	3620lm	3	5.52	1.70	377		
Efficacy	91lm/W	4	7.36	2.27	212		
TS1085	I _{max} =699cd/klm	I _{max}	3389cd	5	9.20	2.84	136



3000K		H(m)	D1(m)	D2(m)	Emax(lx)		
Ra84		85°	32°				
Fixture Power	40W	1	1.84	0.57	3609		
Source Flux	5160lm	2	3.68	1.14	902		
Fixture Flux	3856lm	3	5.52	1.70	401		
Efficacy	96lm/W	4	7.36	2.27	226		
TS1085	I _{max} =699cd/klm	I _{max}	3609cd	5	9.20	2.84	144



3500K		H(m)	D1(m)	D2(m)	Emax(lx)		
Ra84		85°	32°				
Fixture Power	40W	1	1.84	0.57	3693		
Source Flux	5280lm	2	3.68	1.14	923		
Fixture Flux	3945lm	3	5.52	1.70	410		
Efficacy	99lm/W	4	7.36	2.27	231		
TS1085	I _{max} =699cd/klm	I _{max}	3693cd	5	9.20	2.84	148



4000K		H(m)	D1(m)	D2(m)	Emax(lx)		
Ra84		85°	32°				
Fixture Power	40W	1	1.84	0.57	3777		
Source Flux	5400lm	2	3.68	1.14	944		
Fixture Flux	4035lm	3	5.52	1.70	420		
Efficacy	101lm/W	4	7.36	2.27	236		
TS1085	I _{max} =699cd/klm	I _{max}	3777cd	5	9.20	2.84	151

48" FLOOD



2700K		H(m)	D1(m)	D2(m)	Emax(lx)		
Ra84		85°	32°				
Fixture Power	53W	1	1.84	0.57	4518		
Source Flux	6460lm	2	3.68	1.14	1130		
Fixture Flux	4827lm	3	5.52	1.70	502		
Efficacy	91lm/W	4	7.36	2.27	282		
TS1085	I _{max} =699cd/klm	I _{max}	4518cd	5	9.20	2.84	181



3000K		H(m)	D1(m)	D2(m)	Emax(lx)		
Ra84		85°	32°				
Fixture Power	53W	1	1.84	0.57	4812		
Source Flux	6880lm	2	3.68	1.14	1203		
Fixture Flux	5141lm	3	5.52	1.70	535		
Efficacy	97lm/W	4	7.36	2.27	301		
TS1085	I _{max} =699cd/klm	I _{max}	4812cd	5	9.20	2.84	192

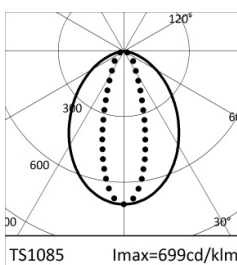

3500K		H(m)	D1(m)	D2(m)	Emax(lx)		
Ra84		85°	32°				
Fixture Power	53W	1	1.84	0.57	4924		
Source Flux	7040lm	2	3.68	1.14	1231		
Fixture Flux	5260lm	3	5.52	1.70	547		
Efficacy	99lm/W	4	7.36	2.27	308		
TS1085	I _{max} =699cd/klm	I _{max}	4924cd	5	9.20	2.84	197



4000K		H(m)	D1(m)	D2(m)	Emax(lx)		
Ra84		85°	32°				
Fixture Power	53W	1	1.84	0.57	5036		
Source Flux	7200lm	2	3.68	1.14	1259		
Fixture Flux	5380lm	3	5.52	1.70	560		
Efficacy	102lm/W	4	7.36	2.27	315		
TS1085	I _{max} =699cd/klm	I _{max}	5036cd	5	9.20	2.84	201

JEDI COMPACT

PHOTOMETRY

24" SPOT



2700K		H(m)	D(m)	Emax(lx)		
Ra84			11°			
Fixture Power	26W	1	0.20	36451		
Source Flux	2862lm	2	0.40	9113		
Fixture Flux	2371lm	3	0.59	4050		
Efficacy	91lm/W	4	0.79	2278		
TS1340	I _{max} =12736cd/klm	I _{max}	36451cd	5	0.99	1458



3000K		H(m)	D(m)	Emax(lx)		
Ra84			11°			
Fixture Power	26W	1	0.20	39584		
Source Flux	3108lm	2	0.40	9896		
Fixture Flux	2575lm	3	0.59	4398		
Efficacy	99lm/W	4	0.79	2474		
TS1340	I _{max} =12736cd/klm	I _{max}	39584cd	5	0.99	1583



3500K		H(m)	D(m)	Emax(lx)		
Ra84			11°			
Fixture Power	26W	1	0.20	40806		
Source Flux	3204lm	2	0.40	10202		
Fixture Flux	2655lm	3	0.59	4534		
Efficacy	102lm/W	4	0.79	2550		
TS1340	I _{max} =12736cd/klm	I _{max}	40806cd	5	0.99	1632



4000K		H(m)	D(m)	Emax(lx)		
Ra84			11°			
Fixture Power	26W	1	0.20	42182		
Source Flux	3312lm	2	0.40	10545		
Fixture Flux	2744lm	3	0.59	4687		
Efficacy	106lm/W	4	0.79	2636		
TS1340	I _{max} =12736cd/klm	I _{max}	42182cd	5	0.99	1687

36" SPOT



2700K		H(m)	D(m)	Emax(lx)		
Ra84			11°			
Fixture Power	38W	1	0.20	54676		
Source Flux	4293lm	2	0.40	13669		
Fixture Flux	3557lm	3	0.59	6075		
Efficacy	94lm/W	4	0.79	3417		
TS1340	I _{max} =12736cd/klm	I _{max}	54676cd	5	0.99	2187



3000K		H(m)	D(m)	Emax(lx)		
Ra84			11°			
Fixture Power	38W	1	0.20	59376		
Source Flux	4662lm	2	0.40	14844		
Fixture Flux	3863lm	3	0.59	6597		
Efficacy	102lm/W	4	0.79	3711		
TS1340	I _{max} =12736cd/klm	I _{max}	59376cd	5	0.99	2375



3500K		H(m)	D(m)	Emax(lx)		
Ra84			11°			
Fixture Power	38W	1	0.20	61210		
Source Flux	4806lm	2	0.40	15302		
Fixture Flux	3982lm	3	0.59	6801		
Efficacy	105lm/W	4	0.79	3826		
TS1340	I _{max} =12736cd/klm	I _{max}	61210cd	5	0.99	2448



4000K		H(m)	D(m)	Emax(lx)		
Ra84			11°			
Fixture Power	38W	1	0.20	63273		
Source Flux	4968lm	2	0.40	15818		
Fixture Flux	4116lm	3	0.59	7030		
Efficacy	108lm/W	4	0.79	3955		
TS1340	I _{max} =12736cd/klm	I _{max}	63273cd	5	0.99	2531

48" SPOT



2700K		H(m)	D(m)	Emax(lx)		
Ra84			11°			
Fixture Power	51W	1	0.20	72901		
Source Flux	5724lm	2	0.40	18225		
Fixture Flux	4743lm	3	0.59	8100		
Efficacy	93lm/W	4	0.79	4556		
TS1340	I _{max} =12736cd/klm	I _{max}	72901cd	5	0.99	2916



3000K		H(m)	D(m)	Emax(lx)		
Ra84			11°			
Fixture Power	51W	1	0.20	79167		
Source Flux	6216lm	2	0.40	19792		
Fixture Flux	5151lm	3	0.59	8796		
Efficacy	101lm/W	4	0.79	4948		
TS1340	I _{max} =12736cd/klm	I _{max}	79167cd	5	0.99	3167



3500K		H(m)	D(m)	Emax(lx)		
Ra84			11°			
Fixture Power	51W	1	0.20	81613		
Source Flux	6408lm	2	0.40	20403		
Fixture Flux	5310lm	3	0.59	9068		
Efficacy	104lm/W	4	0.79	5101		
TS1340	I _{max} =12736cd/klm	I _{max}	81613cd	5	0.99	3265



4000K		H(m)	D(m)	Emax(lx)		
Ra84			11°			
Fixture Power	51W	1	0.20	84364		
Source Flux	6624lm	2	0.40	21091		
Fixture Flux	5489lm	3	0.59	9374		
Efficacy	108lm/W	4	0.79	5273		
TS1340	I _{max} =12736cd/klm	I _{max}	84364cd	5	0.99	3375

JEDI COMPACT

PHOTOMETRY

24" WALL WASHER (WITH LOUVER)

	2700K	H(m)	D1(m)	D2(m)	E _{max} (lx)		
	Ra84	116°	62°				
	Fixture Power	28W	1	3.17	1.49	1802	
	Source Flux	3230lm	2	6.35	2.97	450	
	Fixture Flux	1831lm	3	9.52	4.46	200	
	Efficacy	65lm/W	4	12.70	5.95	113	
TS1094	I _{max} =671cd/klm	I _{max}	2166cd	5	15.87	7.43	72

	3000K	H(m)	D1(m)	D2(m)	E _{max} (lx)		
	Ra84	116°	62°				
	Fixture Power	28W	1	3.17	1.49	1919	
	Source Flux	3440lm	2	6.35	2.97	480	
	Fixture Flux	1950lm	3	9.52	4.46	213	
	Efficacy	70lm/W	4	12.70	5.95	120	
TS1094	I _{max} =671cd/klm	I _{max}	2307cd	5	15.87	7.43	77

	3500K	H(m)	D1(m)	D2(m)	E _{max} (lx)		
	Ra84	116°	62°				
	Fixture Power	28W	1	3.17	1.49	1964	
	Source Flux	3520lm	2	6.35	2.97	491	
	Fixture Flux	1996lm	3	9.52	4.46	218	
	Efficacy	71lm/W	4	12.70	5.95	123	
TS1094	I _{max} =671cd/klm	I _{max}	2360cd	5	15.87	7.43	79

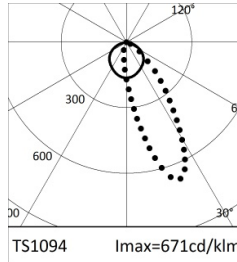
	4000K	H(m)	D1(m)	D2(m)	E _{max} (lx)		
	Ra84	116°	62°				
	Fixture Power	28W	1	3.17	1.49	2008	
	Source Flux	3600lm	2	6.35	2.97	502	
	Fixture Flux	2041lm	3	9.52	4.46	223	
	Efficacy	73lm/W	4	12.70	5.95	126	
TS1094	I _{max} =671cd/klm	I _{max}	2414cd	5	15.87	7.43	80

36" WALL WASHER (WITH LOUVER)

	2700K	H(m)	D1(m)	D2(m)	E _{max} (lx)		
	Ra84	116°	62°				
	Fixture Power	40W	1	3.17	1.49	2703	
	Source Flux	4845lm	2	6.35	2.97	676	
	Fixture Flux	2747lm	3	9.52	4.46	300	
	Efficacy	69lm/W	4	12.70	5.95	169	
TS1095	I _{max} =671cd/klm	I _{max}	3249cd	5	15.87	7.43	108

	3000K	H(m)	D1(m)	D2(m)	E _{max} (lx)		
	Ra84	116°	62°				
	Fixture Power	40W	1	3.17	1.49	2879	
	Source Flux	5160lm	2	6.35	2.97	720	
	Fixture Flux	2926lm	3	9.52	4.46	320	
	Efficacy	73lm/W	4	12.70	5.95	180	
TS1095	I _{max} =671cd/klm	I _{max}	3460cd	5	15.87	7.43	115

	3500K	H(m)	D1(m)	D2(m)	E _{max} (lx)		
	Ra84	116°	62°				
	Fixture Power	40W	1	3.17	1.49	2946	
	Source Flux	5280lm	2	6.35	2.97	736	
	Fixture Flux	2994lm	3	9.52	4.46	327	
	Efficacy	75lm/W	4	12.70	5.95	184	
TS1095	I _{max} =671cd/klm	I _{max}	3541cd	5	15.87	7.43	118

	4000K	H(m)	D1(m)	D2(m)	E _{max} (lx)		
	Ra84	116°	62°				
	Fixture Power	40W	1	3.17	1.49	3012	
	Source Flux	5400lm	2	6.35	2.97	753	
	Fixture Flux	3062lm	3	9.52	4.46	335	
	Efficacy	77lm/W	4	12.70	5.95	188	
TS1095	I _{max} =671cd/klm	I _{max}	3621cd	5	15.87	7.43	120

48" WALL WASHER (WITH LOUVER)

	2700K	H(m)	D1(m)	D2(m)	E _{max} (lx)		
	Ra84	116°	62°				
	Fixture Power	53W	1	3.17	1.49	3604	
	Source Flux	6460lm	2	6.35	2.97	901	
	Fixture Flux	3663lm	3	9.52	4.46	400	
	Efficacy	69lm/W	4	12.70	5.95	225	
TS1095	I _{max} =671cd/klm	I _{max}	4332cd	5	15.87	7.43	144

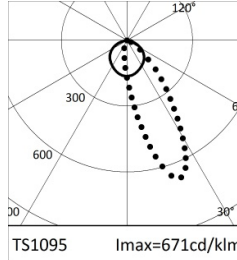
	3000K	H(m)	D1(m)	D2(m)	E _{max} (lx)		
	Ra84	116°	62°				
	Fixture Power	53W	1	3.17	1.49	3838	
	Source Flux	6880lm	2	6.35	2.97	960	
	Fixture Flux	3901lm	3	9.52	4.46	426	
	Efficacy	74lm/W	4	12.70	5.95	240	
TS1095	I _{max} =671cd/klm	I _{max}	4613cd	5	15.87	7.43	154

	3500K	H(m)	D1(m)	D2(m)	E _{max} (lx)		
	Ra84	116°	62°				
	Fixture Power	53W	1	3.17	1.49	3927	
	Source Flux	7040lm	2	6.35	2.97	982	
	Fixture Flux	3992lm	3	9.52	4.46	436	
	Efficacy	75lm/W	4	12.70	5.95	245	
TS1095	I _{max} =671cd/klm	I _{max}	4721cd	5	15.87	7.43	157

	4000K	H(m)	D1(m)	D2(m)	E _{max} (lx)		
	Ra84	116°	62°				
	Fixture Power	53W	1	3.17	1.49	4017	
	Source Flux	7200lm	2	6.35	2.97	1004	
	Fixture Flux	4082lm	3	9.52	4.46	446	
	Efficacy	77lm/W	4	12.70	5.95	251	
TS1095	I _{max} =671cd/klm	I _{max}	4828cd	5	15.87	7.43	161

JEDI COMPACT

PHOTOMETRY

24" WALL GRAZER (WITH LOUVER)

	2700K	H(m)	D1(m)	D2(m)	Emax(lx)		
	Ra84		80°	13°			
	Fixture Power	28W	1	1.68	0.23	3573	
	Source Flux	3230lm	2	3.36	0.46	893	
	Fixture Flux	1712lm	3	5.04	0.68	397	
	Efficacy	61lm/W	4	6.72	0.91	223	
TS1090	I _{max} =1106cd/klm	I _{max}	3573cd	5	8.40	1.14	143

	3000K	H(m)	D1(m)	D2(m)	Emax(lx)		
	Ra84		80°	13°			
	Fixture Power	28W	1	1.68	0.23	3805	
	Source Flux	3440lm	2	3.36	0.46	951	
	Fixture Flux	1824lm	3	5.04	0.68	423	
	Efficacy	65lm/W	4	6.72	0.91	238	
TS1090	I _{max} =1106cd/klm	I _{max}	3805cd	5	8.40	1.14	152

	3500K	H(m)	D1(m)	D2(m)	Emax(lx)		
	Ra84		80°	13°			
	Fixture Power	28W	1	1.68	0.23	3894	
	Source Flux	3520lm	2	3.36	0.46	973	
	Fixture Flux	1866lm	3	5.04	0.68	433	
	Efficacy	67lm/W	4	6.72	0.91	243	
TS1090	I _{max} =1106cd/klm	I _{max}	3894cd	5	8.40	1.14	156

	4000K	H(m)	D1(m)	D2(m)	Emax(lx)		
	Ra84		80°	13°			
	Fixture Power	28W	1	1.68	0.23	3982	
	Source Flux	3600lm	2	3.36	0.46	996	
	Fixture Flux	1908lm	3	5.04	0.68	442	
	Efficacy	68lm/W	4	6.72	0.91	249	
TS1090	I _{max} =1106cd/klm	I _{max}	3982cd	5	8.40	1.14	159

36" WALL GRAZER (WITH LOUVER)

	2700K	H(m)	D1(m)	D2(m)	Emax(lx)		
	Ra84		80°	13°			
	Fixture Power	40W	1	1.68	0.23	5359	
	Source Flux	4845lm	2	3.36	0.46	1340	
	Fixture Flux	2568lm	3	5.04	0.68	595	
	Efficacy	64lm/W	4	6.72	0.91	335	
TS1091	I _{max} =1106cd/klm	I _{max}	5359cd	5	8.40	1.14	214

	3000K	H(m)	D1(m)	D2(m)	Emax(lx)		
	Ra84		80°	13°			
	Fixture Power	40W	1	1.68	0.23	5707	
	Source Flux	5160lm	2	3.36	0.46	1427	
	Fixture Flux	2735lm	3	5.04	0.68	634	
	Efficacy	68lm/W	4	6.72	0.91	357	
TS1091	I _{max} =1106cd/klm	I _{max}	5707cd	5	8.40	1.14	228

	3500K	H(m)	D1(m)	D2(m)	Emax(lx)		
	Ra84		80°	13°			
	Fixture Power	40W	1	1.68	0.23	5840	
	Source Flux	5280lm	2	3.36	0.46	1460	
	Fixture Flux	2798lm	3	5.04	0.68	649	
	Efficacy	70lm/W	4	6.72	0.91	365	
TS1091	I _{max} =1106cd/klm	I _{max}	5840cd	5	8.40	1.14	234

	4000K	H(m)	D1(m)	D2(m)	Emax(lx)		
	Ra84		80°	13°			
	Fixture Power	40W	1	1.68	0.23	5973	
	Source Flux	5400lm	2	3.36	0.46	1493	
	Fixture Flux	2862lm	3	5.04	0.68	664	
	Efficacy	72lm/W	4	6.72	0.91	373	
TS1091	I _{max} =1106cd/klm	I _{max}	5973cd	5	8.40	1.14	239

48" WALL GRAZER (WITH LOUVER)

	2700K	H(m)	D1(m)	D2(m)	Emax(lx)		
	Ra84		80°	13°			
	Fixture Power	53W	1	1.68	0.23	7145	
	Source Flux	6460lm	2	3.36	0.46	1786	
	Fixture Flux	3424lm	3	5.04	0.68	794	
	Efficacy	65lm/W	4	6.72	0.91	447	
TS1091	I _{max} =1106cd/klm	I _{max}	7145cd	5	8.40	1.14	286

	3000K	H(m)	D1(m)	D2(m)	Emax(lx)		
	Ra84		80°	13°			
	Fixture Power	53W	1	1.68	0.23	7609	
	Source Flux	6880lm	2	3.36	0.46	1902	
	Fixture Flux	3646lm	3	5.04	0.68	845	
	Efficacy	69lm/W	4	6.72	0.91	476	
TS1091	I _{max} =1106cd/klm	I _{max}	7609cd	5	8.40	1.14	304

	3500K	H(m)	D1(m)	D2(m)	Emax(lx)		
	Ra84		80°	13°			
	Fixture Power	53W	1	1.68	0.23	7786	
	Source Flux	7040lm	2	3.36	0.46	1947	
	Fixture Flux	3731lm	3	5.04	0.68	865	
	Efficacy	70lm/W	4	6.72	0.91	487	
TS1091	I _{max} =1106cd/klm	I _{max}	7786cd	5	8.40	1.14	311

	4000K	H(m)	D1(m)	D2(m)	Emax(lx)		
	Ra84		80°	13°			
	Fixture Power	53W	1	1.68	0.23	7963	
	Source Flux	7200lm	2	3.36	0.46	1991	
	Fixture Flux	3816lm	3	5.04	0.68	885	
	Efficacy	72lm/W	4	6.72	0.91	498	
TS1091	I _{max} =1106cd/klm	I _{max}	7963cd	5	8.40	1.14	319

JEDI COMPACT

PHOTOMETRY

24" FLOOD (WITH LOUVER)



2700K		H(m)	D1(m)	D2(m)	Emax(lx)
Ra84		86°	29°		
Fixture Power	28W	1	1.86	0.52	1640
Source Flux	3230lm	2	3.71	1.05	410
Fixture Flux	1412lm	3	5.57	1.57	182
Efficacy	50lm/W	4	7.42	2.09	103
TS1086	I _{max} =508cd/klm	I _{max}	1640cd	5	9.28 2.62 66



3000K		H(m)	D1(m)	D2(m)	Emax(lx)
Ra84		86°	29°		
Fixture Power	28W	1	1.86	0.52	1747
Source Flux	3440lm	2	3.71	1.05	437
Fixture Flux	1503lm	3	5.57	1.57	194
Efficacy	54lm/W	4	7.42	2.09	109
TS1086	I _{max} =508cd/klm	I _{max}	1747cd	5	9.28 2.62 70



3500K		H(m)	D1(m)	D2(m)	Emax(lx)
Ra84		86°	29°		
Fixture Power	28W	1	1.86	0.52	1788
Source Flux	3520lm	2	3.71	1.05	447
Fixture Flux	1538lm	3	5.57	1.57	199
Efficacy	55lm/W	4	7.42	2.09	112
TS1086	I _{max} =508cd/klm	I _{max}	1788cd	5	9.28 2.62 72



4000K		H(m)	D1(m)	D2(m)	Emax(lx)
Ra84		86°	29°		
Fixture Power	28W	1	1.86	0.52	1828
Source Flux	3600lm	2	3.71	1.05	457
Fixture Flux	1573lm	3	5.57	1.57	203
Efficacy	56lm/W	4	7.42	2.09	114
TS1086	I _{max} =508cd/klm	I _{max}	1828cd	5	9.28 2.62 73

36" FLOOD (WITH LOUVER)



2700K		H(m)	D1(m)	D2(m)	Emax(lx)
Ra84		86°	29°		
Fixture Power	40W	1	1.86	0.52	2460
Source Flux	4845lm	2	3.71	1.05	615
Fixture Flux	2117lm	3	5.57	1.57	273
Efficacy	53lm/W	4	7.42	2.09	154
TS1087	I _{max} =508cd/klm	I _{max}	2460cd	5	9.28 2.62 98



3000K		H(m)	D1(m)	D2(m)	Emax(lx)
Ra84		86°	29°		
Fixture Power	40W	1	1.86	0.52	2620
Source Flux	5160lm	2	3.71	1.05	655
Fixture Flux	2255lm	3	5.57	1.57	291
Efficacy	56lm/W	4	7.42	2.09	164
TS1087	I _{max} =508cd/klm	I _{max}	2620cd	5	9.28 2.62 105

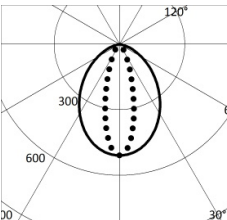

3500K		H(m)	D1(m)	D2(m)	Emax(lx)
Ra84		86°	29°		
Fixture Power	40W	1	1.86	0.52	2681
Source Flux	5280lm	2	3.71	1.05	670
Fixture Flux	2307lm	3	5.57	1.57	298
Efficacy	58lm/W	4	7.42	2.09	168
TS1087	I _{max} =508cd/klm	I _{max}	2681cd	5	9.28 2.62 107



4000K		H(m)	D1(m)	D2(m)	Emax(lx)
Ra84		86°	29°		
Fixture Power	40W	1	1.86	0.52	2742
Source Flux	5400lm	2	3.71	1.05	686
Fixture Flux	2360lm	3	5.57	1.57	305
Efficacy	59lm/W	4	7.42	2.09	171
TS1087	I _{max} =508cd/klm	I _{max}	2742cd	5	9.28 2.62 110

48" FLOOD (WITH LOUVER)



2700K		H(m)	D1(m)	D2(m)	Emax(lx)
Ra84		86°	29°		
Fixture Power	53W	1	1.86	0.52	3281
Source Flux	6460lm	2	3.71	1.05	820
Fixture Flux	2823lm	3	5.57	1.57	365
Efficacy	53lm/W	4	7.42	2.09	205
TS1087	I _{max} =508cd/klm	I _{max}	3281cd	5	9.28 2.62 131



3000K		H(m)	D1(m)	D2(m)	Emax(lx)
Ra84		86°	29°		
Fixture Power	53W	1	1.86	0.52	3494
Source Flux	6880lm	2	3.71	1.05	873
Fixture Flux	3007lm	3	5.57	1.57	388
Efficacy	57lm/W	4	7.42	2.09	218
TS1087	I _{max} =508cd/klm	I _{max}	3494cd	5	9.28 2.62 140



3500K		H(m)	D1(m)	D2(m)	Emax(lx)
Ra84		86°	29°		
Fixture Power	53W	1	1.86	0.52	3575
Source Flux	7040lm	2	3.71	1.05	894
Fixture Flux	3076lm	3	5.57	1.57	397
Efficacy	58lm/W	4	7.42	2.09	223
TS1087	I _{max} =508cd/klm	I _{max}	3575cd	5	9.28 2.62 143



4000K		H(m)	D1(m)	D2(m)	Emax(lx)
Ra84		86°	29°		
Fixture Power	53W	1	1.86	0.52	3656
Source Flux	7200lm	2	3.71	1.05	914
Fixture Flux	3146lm	3	5.57	1.57	406
Efficacy	59lm/W	4	7.42	2.09	229
TS1087	I _{max} =508cd/klm	I _{max}	3656cd	5	9.28 2.62 146