

# JEDI COMPACT REMOTE

## Linear LED Floodlight Projector with Remote Driver

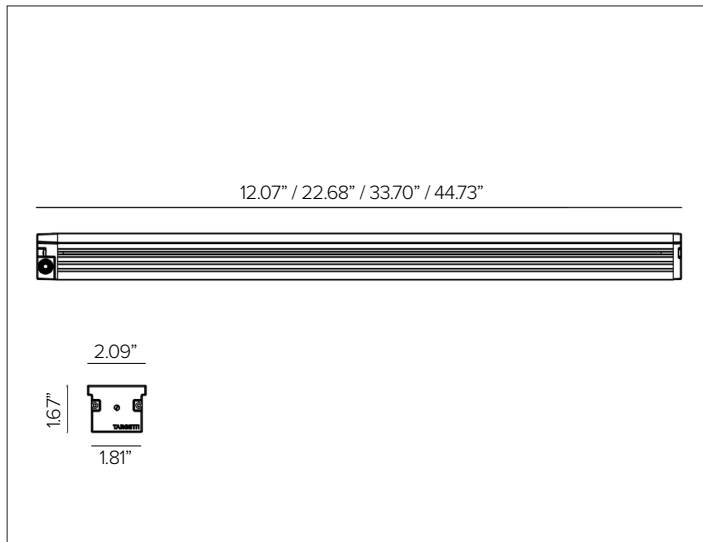

### CONCEPT

Powerful compact adjustable linear LED projector floodlight.

### MECHANICAL CHARACTERISTICS

<b>Housing</b>	1.67"D X 2.09"W
<b>Materials</b>	Extruded anodized aluminum 15µ body with extra clear 5mm thick flat glass.
<b>Finish</b>	● Natural
<b>Power Connection</b>	Factory pre-wired 10ft 18-3 Belden cable from driver enclosure to fixture. From driver to j-box, 10ft SJ00W 16-6 cable and DSM&T anti-wicking quick disconnect, 600V rated line voltage and 0-10V control.
<b>Functionality</b>	The body of the fixture is adjustable and can be installed away from the mounting surface using accessory snap brackets.
<b>Mounting</b>	To be completed with surface adjustable mounting bracket or landscape permast mounting, see available options.
<b>Weight</b>	2lbs (12.07") / 3.6lbs (22.68") / 5lbs (33.70") / 7.1lbs (44.73")
<b>Protection</b>	IP67
<b>Impact</b>	IK08

### CERTIFICATIONS

cULus Class 2 Wet Location Listed  
 Tested in accordance with LM-79-08.  
 Compliant for California installations.  
 IEC 62471  
 RoHS3 EU 215/863

### WARRANTY

5 year limited warranty  
<sup>A</sup> Fixture body suitable for use in marine grade environments. Trim will need to be maintained and cleaned regularly to avoid mineral deposits. Not to be in direct contact with salt or corrosive agents for extended periods of time.

### SUSTAINABILITY

Luminaire designed for disposal/recycling at end-of-life. Replaceable LED light source and control gear by a Targetti technician.

### ELECTRICAL CHARACTERISTICS

<b>Power Supply</b>	Local remote electronic driver, see available options.
<b>Wattage</b>	12W (12.07"L) / 24W (22.68"L) / 36W (33.70"L) / 48W (44.73"L) nominal.

### SOURCE

SP: High efficiency LED emitter. WW / WG / FL / DV: Linear high efficiency LED board.

TM30	CCT (Nominal)	CRI	Rf	Rg	SDCM
	2700K	80	83	97.3	3
	3000K	80	82.9	97	3
	3500K	80	83.6	96.5	3
	4000K	80	82.6	95.7	3

*Ra90 available upon request*

### OPTIC

Optical system is dependent on beam angle. WW / WG / FL is comprised of a primary cylindrical methacrylate lens and a high reflectance anodized aluminum reflector with an integrated holographic filter. SP is comprised of individual lenses for more precise beam and higher intensity. DV is comprised of white silk-screen tempered glass.

Beam	WW 59°x115°	WG 15°x76°	FL 32°x85°	SP 11°x11°
<b>Delivered Lumens</b>	<b>2700K</b> 2428Lm	2684Lm	2413Lm	2371Lm
	<b>3000K</b> 2586Lm	2858Lm	2570Lm	2501Lm
	<b>3500K</b> 2646Lm	2924Lm	2630Lm	2655Lm
	<b>4000K</b> 2706Lm	2991Lm	2690Lm	2744Lm

Data represents 24.60" version only, refer to photometry section for all fixture variations.

<b>Efficacy</b>	119Lm/W max. Refer to photometric graphs for specific values.
<b>Lifetime</b>	WW / WG / FL: L80/B10 62,000hrs at max TA +25°C SP: L80/B10 60,000hrs at max TA +25°C
<b>Photobiological Classification</b>	Low risk safety RG1

# JEDI COMPACT REMOTE

## SPECIFICATION INFORMATION

<b>JE</b>	<b>C</b>								
1	2	3	4	5	6	7	8	9	10
Ex: JECORPWW1230 / PS070 / 1E3304						OPTIONAL	REQUIRED	OPTIONAL	

1 - PRODUCT CODE	2 - TYPE	2 - TYPE	3 - DRIVER	4 - OPTIC	5 - LENGTH	6 - KELVIN
<b>JE</b> — JEDI	<b>C</b> — Compact	<b>O</b> — Outdoor	<b>RP</b> — Remote Driver	<b>WW</b> — WW 59°x115° <b>WG</b> — WG 15°x76° <b>FL</b> — FL 32°x85° <b>SP</b> <sup>B</sup> — SP 11°x11°	<b>12</b> — 12.07" <b>24</b> — 22.68" <b>36</b> — 33.70" <b>48</b> — 44.73"	<b>27</b> — 2700K <b>30</b> — 3000K <b>35</b> — 3500K <b>40</b> — 4000K
7 - OPTICAL ACCESSORY	8 - POWER SUPPLY	9 - MOUNTING	10 - EXTERNAL OPTICAL ACCESSORY			
<b>LV</b> <sup>B</sup> — Integral Anti-Glare Louver	<a href="#">Power Supply</a> See section for details	<a href="#">Short Bracket</a> See section for details <a href="#">Long Bracket</a> See section for details <a href="#">Permapost</a> See section for details	<a href="#">Symmetric Grid</a> See section for details <a href="#">Asymmetric Grid</a> See section for details <a href="#">Fixed Visor</a> See section for details <a href="#">Adjustable Visor</a> See section for details			

<sup>B</sup> LV option not available with SP optic.

## OPTIC VERSIONS

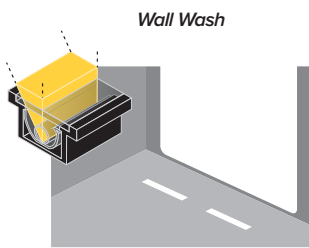

**Wall Wash**

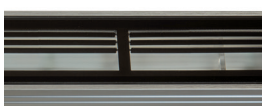

**Integral Louver (WW optic)**

Optional integral anti-glare louver, factory installed inside fixture.

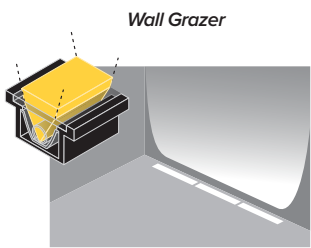

**Wall Grazer**



**Integral Louver (WG & FL optics)**

Optional integral anti-glare louver, factory installed inside fixture.

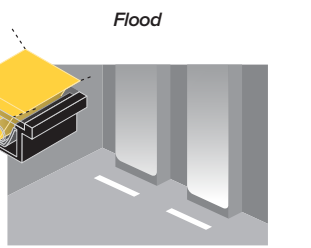

**Flood**

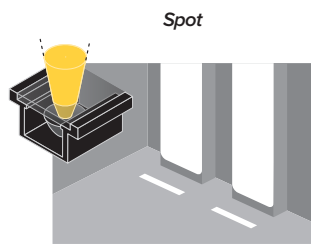

**Spot**

**No Louver Option (SP optic only)**

# JEDI COMPACT REMOTE

## 8 – POWER SUPPLY (REQUIRED)

ENCLOSURE								
Part No.	Wattage	Control	Dim Range	Rating	In / Out Voltage	Certification	Dimensions	Description
<b>PS070</b>	20W <i>(ONE 13"L Fixture)</i>	0-10V	0%	IP66	120-277V 450mA / 24V	UR Class 2	6.25" x 4.00" x 2.38"	EldoLED SOLOdrive with enclosure box, black finish.
<b>PS071</b>	30W <i>(ONE 24"L Fixture)</i>	0-10V	0%	IP66	120-277V 450mA / 24V	UR Class 2	6.25" x 4.00" x 2.38"	EldoLED SOLOdrive with enclosure box, black finish.
<b>PS072</b>	50W <i>(ONE 35"L Fixture)</i>	0-10V	0%	IP66	120-277V 1350mA / 24V	UR Class 2	6.25" x 4.00" x 2.38"	EldoLED SOLOdrive with enclosure box, black finish.
<b>PS073</b>	50W <i>(ONE 46"L Fixture)</i>	0-10V	0%	IP66	120-277V 900mA / 24V	UR Class 2	6.25" x 4.00" x 2.38"	EldoLED SOLOdrive with enclosure box, black finish.

### MAX REMOTE FIXTURE TO DRIVER DISTANCE

Fixture Length	Fixture Load	18 AWG	16 AWG	14 AWG	12 AWG
<b>1ft</b>	<b>12W</b>	<b>90ft</b>	<b>145ft</b>	<b>235ft</b>	<b>375ft</b>
<b>2ft</b>	<b>24W</b>	<b>45ft</b>	<b>70ft</b>	<b>115ft</b>	<b>185ft</b>
<b>3ft</b>	<b>36W</b>	<b>30ft</b>	<b>50ft</b>	<b>80ft</b>	<b>130ft</b>
<b>4ft</b>	<b>48W</b>	<b>25ft</b>	<b>40ft</b>	<b>60ft</b>	<b>100ft</b>

\*Max voltage drop calculated to 3% using stranded copper conductor.

## 9 – MOUNTING (REQUIRED)

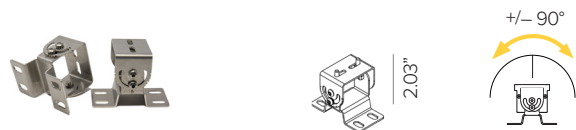

JEDI COMPACT short stainless steel mounting bracket for surface installation (2pcs).

Part No. **1E3304**



JEDI COMPACT long stainless steel mounting bracket for surface installation (2pcs).

Part No. **1E3306**

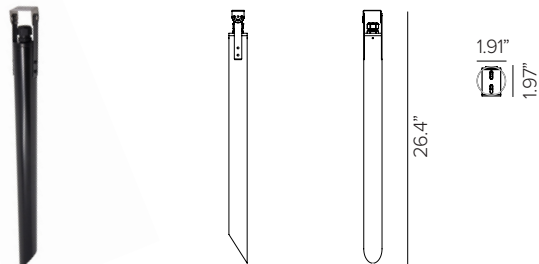

JEDI COMPACT aluminum permastap with stainless steel long mounting bracket (2pcs) and (2pcs) stabilizers.

Finish ● Deep Black

Part No. **JECOPP24**

# JEDI COMPACT REMOTE

## 10 – EXTERNAL ACCESSORY (OPTIONAL)

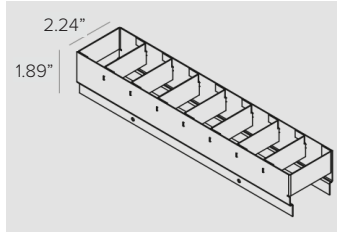

JEDI COMPACT external symmetric stainless steel grid. **To be used with SP / FL / WG optics only.**

Finish	● Deep Black			
Length	11.02"	22.68"	33.70"	44.73"
Part No.	<b>1E3900</b>	<b>1E3901</b>	<b>1E3902</b>	<b>1E3903</b>

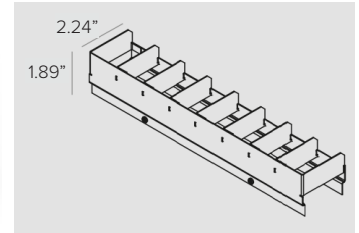

JEDI COMPACT external asymmetric stainless steel grid.

Finish	● Deep Black			
Length	11.02"	22.68"	33.70"	44.73"
Part No.	<b>1E3904</b>	<b>1E3905</b>	<b>1E3906</b>	<b>1E3907</b>

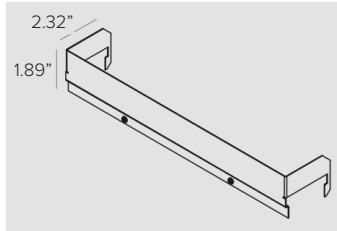

JEDI COMPACT external fixed stainless steel visor.

Finish	● Deep Black			
Length	11.41"	22.68"	33.70"	44.73"
Part No.	<b>1E3908</b>	<b>1E3909</b>	<b>1E3910</b>	<b>1E3911</b>

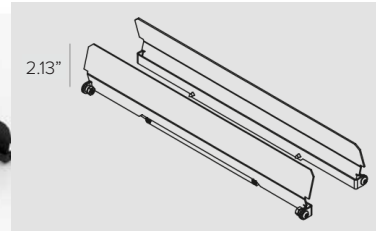

JEDI COMPACT external adjustable stainless steel visor.

Finish	● Deep Black			
Length	11.65"	22.68"	33.70"	44.73"
Part No.	<b>1E3912</b>	<b>1E3913</b>	<b>1E3914</b>	<b>1E3915</b>

# JEDI COMPACT REMOTE

## PERMAPOST INSTALLATION DIAGRAM

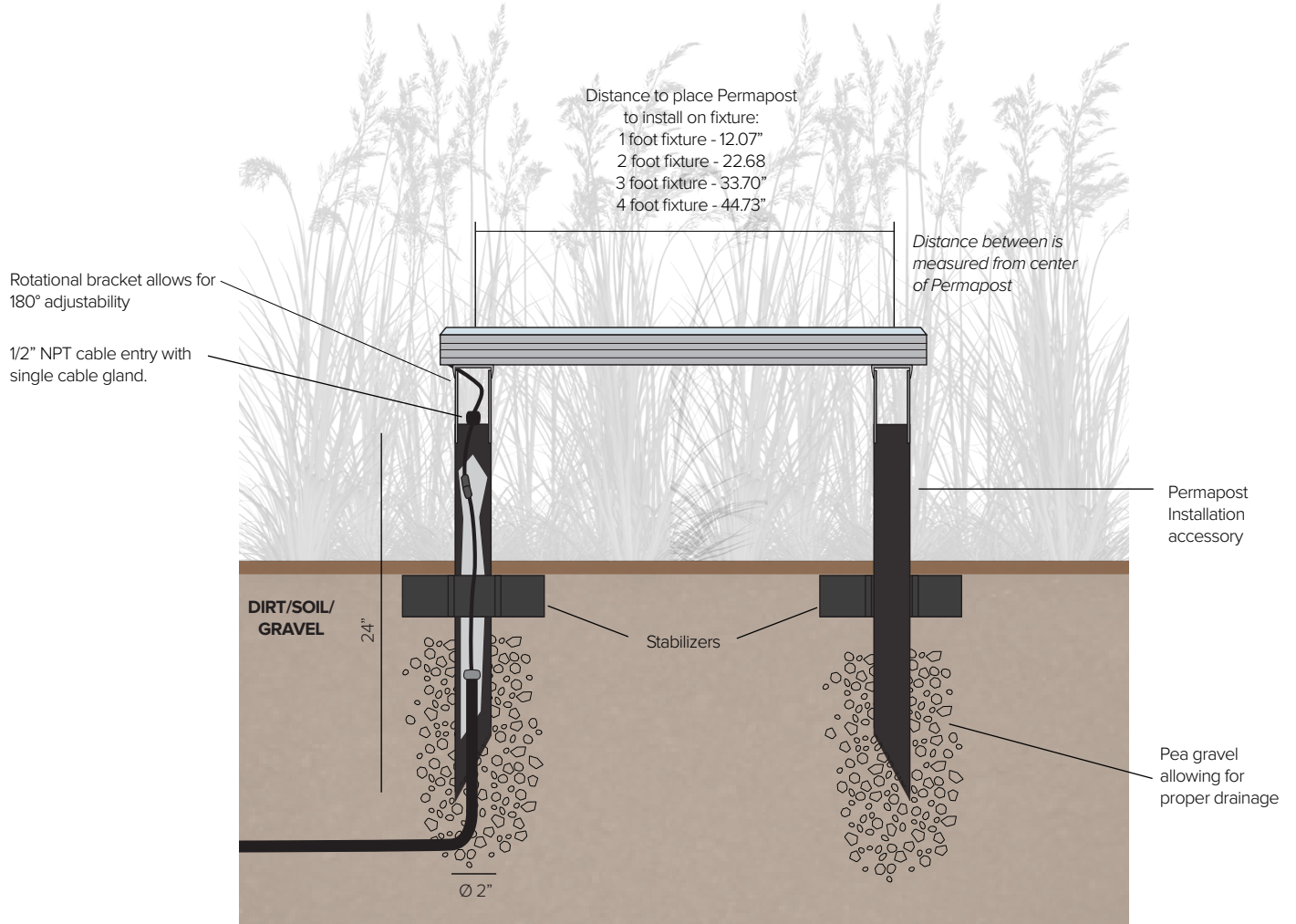

# JEDI COMPACT REMOTE

## PHOTOMETRY

IES FILES WATTAGE AND EFFICIENCY CALCULATIONS BASED WITH SUPPLIED DRIVER

### 12" SPOT

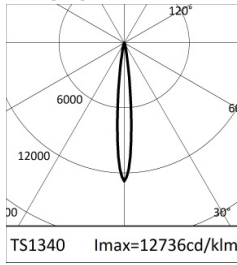

2700K		H(m)	D(m)	Emax(lx)		
Ra80			11°			
Fixture Power	12W	1	0.20	18225		
Source Flux	1431lm	2	0.40	4556		
Fixture Flux	1186lm	3	0.59	2025		
Efficacy	99lm/W	4	0.79	1139		
TS1340	I <sub>max</sub> =12736cd/klm	I <sub>max</sub>	18225cd	5	0.99	729

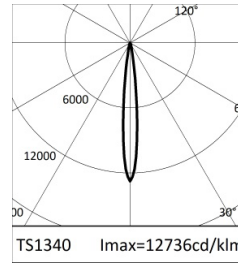

3000K		H(m)	D(m)	Emax(lx)		
Ra80			11°			
Fixture Power	12W	1	0.20	19792		
Source Flux	1554lm	2	0.40	4948		
Fixture Flux	1288lm	3	0.59	2199		
Efficacy	107lm/W	4	0.79	1237		
TS1340	I <sub>max</sub> =12736cd/klm	I <sub>max</sub>	19792cd	5	0.99	792

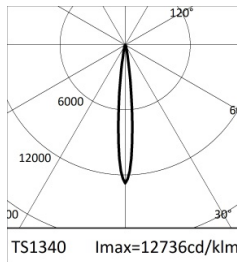

3500K		H(m)	D(m)	Emax(lx)		
Ra80			11°			
Fixture Power	12W	1	0.20	20403		
Source Flux	1602lm	2	0.40	5101		
Fixture Flux	1327lm	3	0.59	2267		
Efficacy	111lm/W	4	0.79	1275		
TS1340	I <sub>max</sub> =12736cd/klm	I <sub>max</sub>	20403cd	5	0.99	816

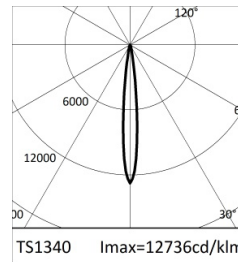

4000K		H(m)	D(m)	Emax(lx)		
Ra80			11°			
Fixture Power	12W	1	0.20	21091		
Source Flux	1656lm	2	0.40	5273		
Fixture Flux	1372lm	3	0.59	2343		
Efficacy	114lm/W	4	0.79	1318		
TS1340	I <sub>max</sub> =12736cd/klm	I <sub>max</sub>	21091cd	5	0.99	844

### 24" SPOT

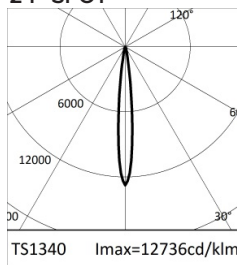

2700K		H(m)	D(m)	Emax(lx)		
Ra80			11°			
Fixture Power	23W	1	0.20	36451		
Source Flux	2862lm	2	0.40	9113		
Fixture Flux	2371lm	3	0.59	4050		
Efficacy	103lm/W	4	0.79	2278		
TS1340	I <sub>max</sub> =12736cd/klm	I <sub>max</sub>	36451cd	5	0.99	1458

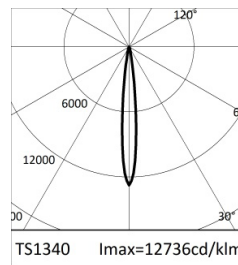

3000K		H(m)	D(m)	Emax(lx)		
Ra80			11°			
Fixture Power	23W	1	0.20	38437		
Source Flux	3018lm	2	0.40	9609		
Fixture Flux	2501lm	3	0.59	4271		
Efficacy	109lm/W	4	0.79	2402		
TS1340	I <sub>max</sub> =12736cd/klm	I <sub>max</sub>	38437cd	5	0.99	1537

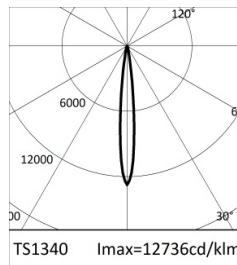

3500K		H(m)	D(m)	Emax(lx)		
Ra80			11°			
Fixture Power	23W	1	0.20	40806		
Source Flux	3204lm	2	0.40	10202		
Fixture Flux	2655lm	3	0.59	4534		
Efficacy	115lm/W	4	0.79	2550		
TS1340	I <sub>max</sub> =12736cd/klm	I <sub>max</sub>	40806cd	5	0.99	1632

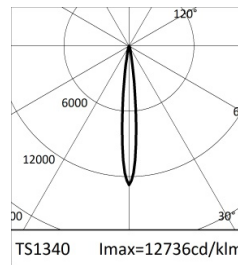

4000K		H(m)	D(m)	Emax(lx)		
Ra80			11°			
Fixture Power	23W	1	0.20	42182		
Source Flux	3312lm	2	0.40	10545		
Fixture Flux	2744lm	3	0.59	4687		
Efficacy	119lm/W	4	0.79	2636		
TS1340	I <sub>max</sub> =12736cd/klm	I <sub>max</sub>	42182cd	5	0.99	1687

### 36" SPOT

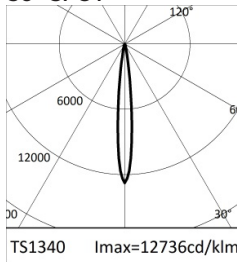

2700K		H(m)	D(m)	Emax(lx)		
Ra80			11°			
Fixture Power	35W	1	0.20	54676		
Source Flux	4293lm	2	0.40	13669		
Fixture Flux	3557lm	3	0.59	6075		
Efficacy	102lm/W	4	0.79	3417		
TS1340	I <sub>max</sub> =12736cd/klm	I <sub>max</sub>	54676cd	5	0.99	2187

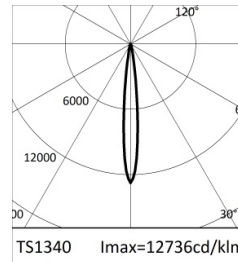

3000K		H(m)	D(m)	Emax(lx)		
Ra80			11°			
Fixture Power	35W	1	0.20	59376		
Source Flux	4662lm	2	0.40	14844		
Fixture Flux	3863lm	3	0.59	6597		
Efficacy	110lm/W	4	0.79	3711		
TS1340	I <sub>max</sub> =12736cd/klm	I <sub>max</sub>	59376cd	5	0.99	2375

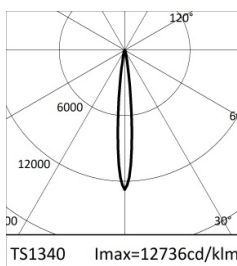

3500K		H(m)	D(m)	Emax(lx)		
Ra80			11°			
Fixture Power	35W	1	0.20	61210		
Source Flux	4806lm	2	0.40	15302		
Fixture Flux	3982lm	3	0.59	6801		
Efficacy	114lm/W	4	0.79	3826		
TS1340	I <sub>max</sub> =12736cd/klm	I <sub>max</sub>	61210cd	5	0.99	2448

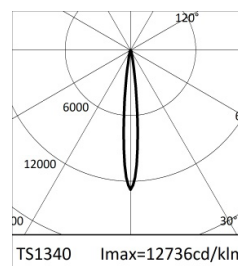

4000K		H(m)	D(m)	Emax(lx)		
Ra80			11°			
Fixture Power	35W	1	0.20	63273		
Source Flux	4968lm	2	0.40	15818		
Fixture Flux	4116lm	3	0.59	7030		
Efficacy	118lm/W	4	0.79	3955		
TS1340	I <sub>max</sub> =12736cd/klm	I <sub>max</sub>	63273cd	5	0.99	2531

# JEDI COMPACT REMOTE

## PHOTOMETRY

IES FILES WATTAGE AND EFFICIENCY CALCULATIONS BASED WITH SUPPLIED DRIVER

### 48" SPOT

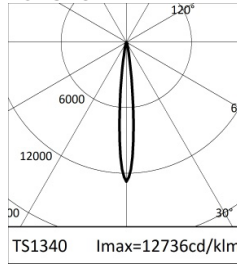

2700K		H(m)	D(m)	E <sub>max</sub> (lx)
Ra80		11°		
Fixture Power	46W	1	0.20	72901
Source Flux	5724lm	2	0.40	18225
Fixture Flux	4743lm	3	0.59	8100
Efficacy	103lm/W	4	0.79	4556
TS1340	I <sub>max</sub> =12736cd/klm	I <sub>max</sub>	72901cd	5 0.99 2916

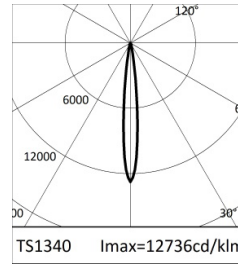

3000K		H(m)	D(m)	E <sub>max</sub> (lx)
Ra80		11°		
Fixture Power	46W	1	0.20	79167
Source Flux	6216lm	2	0.40	19792
Fixture Flux	5151lm	3	0.59	8796
Efficacy	112lm/W	4	0.79	4948
TS1340	I <sub>max</sub> =12736cd/klm	I <sub>max</sub>	79167cd	5 0.99 3167

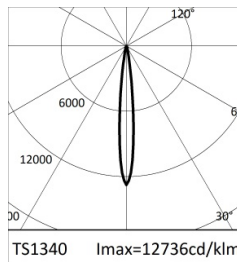

3500K		H(m)	D(m)	E <sub>max</sub> (lx)
Ra80		11°		
Fixture Power	46W	1	0.20	81613
Source Flux	6408lm	2	0.40	20403
Fixture Flux	5310lm	3	0.59	9068
Efficacy	115lm/W	4	0.79	5101
TS1340	I <sub>max</sub> =12736cd/klm	I <sub>max</sub>	81613cd	5 0.99 3265

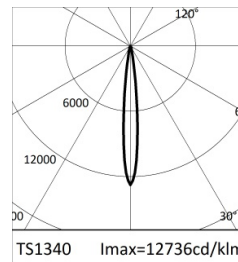

4000K		H(m)	D(m)	E <sub>max</sub> (lx)
Ra80		11°		
Fixture Power	46W	1	0.20	84364
Source Flux	6624lm	2	0.40	21091
Fixture Flux	5489lm	3	0.59	9374
Efficacy	119lm/W	4	0.79	5273
TS1340	I <sub>max</sub> =12736cd/klm	I <sub>max</sub>	84364cd	5 0.99 3375

### 12" WALL WASHER



2700K		H(m)	D1(m)	D2(m)	E <sub>max</sub> (lx)
Ra80		115°		59°	
Fixture Power	12W	1	3.12	1.34	1085
Source Flux	1615lm	2	6.23	2.67	271
Fixture Flux	1214lm	3	9.35	4.01	121
Efficacy	101lm/W	4	12.47	5.35	68
TS1092	I <sub>max</sub> =774cd/klm	I <sub>max</sub>	1249cd	5 15.59 6.69	43

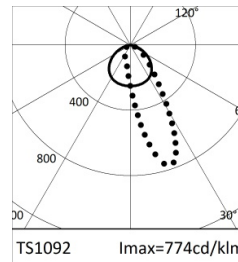

3000K		H(m)	D1(m)	D2(m)	E <sub>max</sub> (lx)
Ra80		115°		59°	
Fixture Power	12W	1	3.12	1.34	1156
Source Flux	1720lm	2	6.23	2.67	289
Fixture Flux	1293lm	3	9.35	4.01	128
Efficacy	108lm/W	4	12.47	5.35	72
TS1092	I <sub>max</sub> =774cd/klm	I <sub>max</sub>	1331cd	5 15.59 6.69	46



3500K		H(m)	D1(m)	D2(m)	E <sub>max</sub> (lx)
Ra80		115°		59°	
Fixture Power	12W	1	3.12	1.34	1183
Source Flux	1760lm	2	6.23	2.67	296
Fixture Flux	1323lm	3	9.35	4.01	131
Efficacy	110lm/W	4	12.47	5.35	74
TS1092	I <sub>max</sub> =774cd/klm	I <sub>max</sub>	1361cd	5 15.59 6.69	47



4000K		H(m)	D1(m)	D2(m)	E <sub>max</sub> (lx)
Ra80		115°		59°	
Fixture Power	12W	1	3.12	1.34	1210
Source Flux	1800lm	2	6.23	2.67	302
Fixture Flux	1353lm	3	9.35	4.01	134
Efficacy	113lm/W	4	12.47	5.35	76
TS1092	I <sub>max</sub> =774cd/klm	I <sub>max</sub>	1392cd	5 15.59 6.69	48

### 24" WALL WASHER

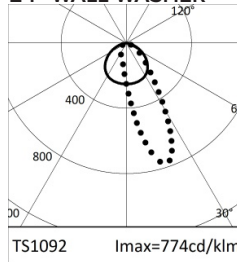

2700K		H(m)	D1(m)	D2(m)	E <sub>max</sub> (lx)
Ra80		115°		59°	
Fixture Power	24W	1	3.12	1.34	2171
Source Flux	3230lm	2	6.23	2.67	543
Fixture Flux	2428lm	3	9.35	4.01	241
Efficacy	101lm/W	4	12.47	5.35	136
TS1092	I <sub>max</sub> =774cd/klm	I <sub>max</sub>	2499cd	5 15.59 6.69	87

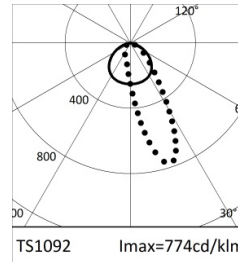

3000K		H(m)	D1(m)	D2(m)	E <sub>max</sub> (lx)
Ra80		115°		59°	
Fixture Power	24W	1	3.12	1.34	2312
Source Flux	3440lm	2	6.23	2.67	578
Fixture Flux	2586lm	3	9.35	4.01	257
Efficacy	108lm/W	4	12.47	5.35	145
TS1092	I <sub>max</sub> =774cd/klm	I <sub>max</sub>	2661cd	5 15.59 6.69	92

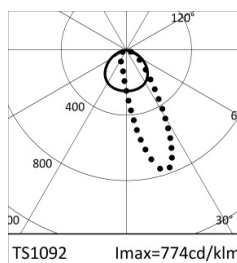

3500K		H(m)	D1(m)	D2(m)	E <sub>max</sub> (lx)
Ra80		115°		59°	
Fixture Power	24W	1	3.12	1.34	2366
Source Flux	3520lm	2	6.23	2.67	591
Fixture Flux	2646lm	3	9.35	4.01	263
Efficacy	110lm/W	4	12.47	5.35	148
TS1092	I <sub>max</sub> =774cd/klm	I <sub>max</sub>	2723cd	5 15.59 6.69	95



4000K		H(m)	D1(m)	D2(m)	E <sub>max</sub> (lx)
Ra80		115°		59°	
Fixture Power	24W	1	3.12	1.34	2420
Source Flux	3600lm	2	6.23	2.67	605
Fixture Flux	2706lm	3	9.35	4.01	269
Efficacy	113lm/W	4	12.47	5.35	151
TS1092	I <sub>max</sub> =774cd/klm	I <sub>max</sub>	2785cd	5 15.59 6.69	97

# JEDI COMPACT REMOTE

## PHOTOMETRY

IES FILES WATTAGE AND EFFICIENCY CALCULATIONS BASED WITH SUPPLIED DRIVER

### 36" WALL WASHER

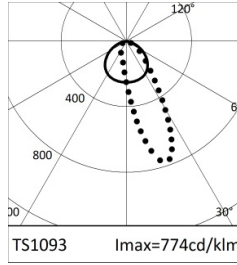

2700K		H(m)	D1(m)	D2(m)	Emax(lx)		
Ra80		115°	59°				
Fixture Power	36W	1	3.12	1.34	3256		
Source Flux	4845lm	2	6.23	2.67	814		
Fixture Flux	3642lm	3	9.35	4.01	362		
Efficacy	101lm/W	4	12.47	5.35	204		
TS1093	Imax=774cd/klm	Imax	3748cd	5	15.59	6.69	130

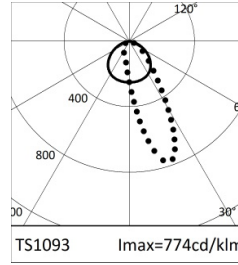

3000K		H(m)	D1(m)	D2(m)	Emax(lx)		
Ra80		115°	59°				
Fixture Power	36W	1	3.12	1.34	3468		
Source Flux	5160lm	2	6.23	2.67	867		
Fixture Flux	3879lm	3	9.35	4.01	385		
Efficacy	108lm/W	4	12.47	5.35	217		
TS1093	Imax=774cd/klm	Imax	3992cd	5	15.59	6.69	139

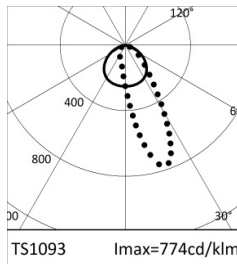

3500K		H(m)	D1(m)	D2(m)	Emax(lx)		
Ra80		115°	59°				
Fixture Power	36W	1	3.12	1.34	3549		
Source Flux	5280lm	2	6.23	2.67	887		
Fixture Flux	3970lm	3	9.35	4.01	394		
Efficacy	110lm/W	4	12.47	5.35	222		
TS1093	Imax=774cd/klm	Imax	4084cd	5	15.59	6.69	142

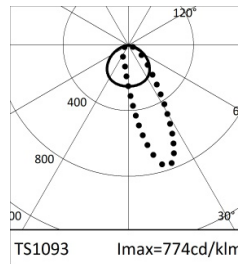

4000K		H(m)	D1(m)	D2(m)	Emax(lx)		
Ra80		115°	59°				
Fixture Power	36W	1	3.12	1.34	3629		
Source Flux	5400lm	2	6.23	2.67	907		
Fixture Flux	4060lm	3	9.35	4.01	403		
Efficacy	113lm/W	4	12.47	5.35	227		
TS1093	Imax=774cd/klm	Imax	4177cd	5	15.59	6.69	145

### 48" WALL WASHER



2700K		H(m)	D1(m)	D2(m)	Emax(lx)		
Ra80		115°	59°				
Fixture Power	48W	1	3.12	1.34	4342		
Source Flux	6460lm	2	6.23	2.67	1085		
Fixture Flux	4857lm	3	9.35	4.01	482		
Efficacy	101lm/W	4	12.47	5.35	271		
TS1093	Imax=774cd/klm	Imax	4997cd	5	15.59	6.69	174

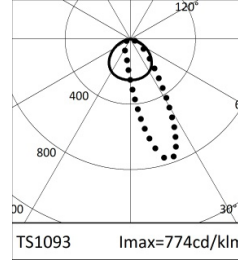

3000K		H(m)	D1(m)	D2(m)	Emax(lx)		
Ra80		115°	59°				
Fixture Power	48W	1	3.12	1.34	4624		
Source Flux	6880lm	2	6.23	2.67	1156		
Fixture Flux	5172lm	3	9.35	4.01	514		
Efficacy	108lm/W	4	12.47	5.35	289		
TS1093	Imax=774cd/klm	Imax	5322cd	5	15.59	6.69	185

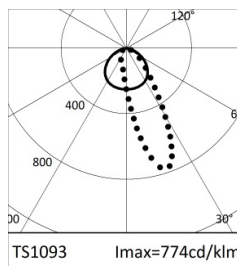

3500K		H(m)	D1(m)	D2(m)	Emax(lx)		
Ra80		115°	59°				
Fixture Power	48W	1	3.12	1.34	4732		
Source Flux	7040lm	2	6.23	2.67	1183		
Fixture Flux	5293lm	3	9.35	4.01	526		
Efficacy	110lm/W	4	12.47	5.35	296		
TS1093	Imax=774cd/klm	Imax	5446cd	5	15.59	6.69	189

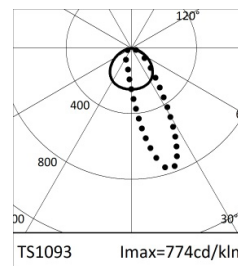

4000K		H(m)	D1(m)	D2(m)	Emax(lx)		
Ra80		115°	59°				
Fixture Power	48W	1	3.12	1.34	4839		
Source Flux	7200lm	2	6.23	2.67	1210		
Fixture Flux	5413lm	3	9.35	4.01	538		
Efficacy	113lm/W	4	12.47	5.35	302		
TS1093	Imax=774cd/klm	Imax	5570cd	5	15.59	6.69	194

### 12" WALL GRAZER

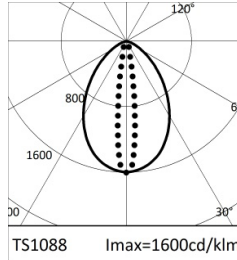

2700K		H(m)	D1(m)	D2(m)	Emax(lx)		
Ra80		76°	15°				
Fixture Power	12W	1	1.55	0.26	2584		
Source Flux	1615lm	2	3.10	0.51	646		
Fixture Flux	1342lm	3	4.65	0.77	287		
Efficacy	112lm/W	4	6.21	1.02	162		
TS1088	Imax=1600cd/klm	Imax	2584cd	5	7.76	1.28	103

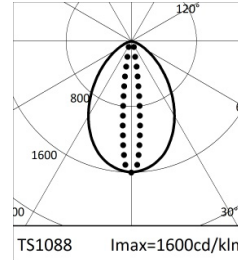

3000K		H(m)	D1(m)	D2(m)	Emax(lx)		
Ra80		76°	15°				
Fixture Power	12W	1	1.55	0.26	2752		
Source Flux	1720lm	2	3.10	0.51	688		
Fixture Flux	1429lm	3	4.65	0.77	306		
Efficacy	119lm/W	4	6.21	1.02	172		
TS1088	Imax=1600cd/klm	Imax	2752cd	5	7.76	1.28	110

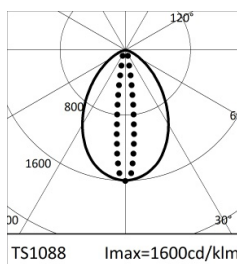

3500K		H(m)	D1(m)	D2(m)	Emax(lx)		
Ra80		76°	15°				
Fixture Power	12W	1	1.55	0.26	2816		
Source Flux	1760lm	2	3.10	0.51	704		
Fixture Flux	1462lm	3	4.65	0.77	313		
Efficacy	122lm/W	4	6.21	1.02	176		
TS1088	Imax=1600cd/klm	Imax	2816cd	5	7.76	1.28	113

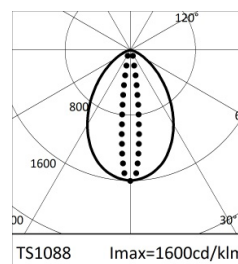

4000K		H(m)	D1(m)	D2(m)	Emax(lx)		
Ra80		76°	15°				
Fixture Power	12W	1	1.55	0.26	2880		
Source Flux	1800lm	2	3.10	0.51	720		
Fixture Flux	1495lm	3	4.65	0.77	320		
Efficacy	125lm/W	4	6.21	1.02	180		
TS1088	Imax=1600cd/klm	Imax	2880cd	5	7.76	1.28	115



# JEDI COMPACT REMOTE

## PHOTOMETRY

IES FILES WATTAGE AND EFFICIENCY CALCULATIONS BASED WITH SUPPLIED DRIVER

### 24" WALL GRAZER



2700K		H(m)	D1(m)	D2(m)	Emax(lx)		
Ra80		76°	15°				
Fixture Power	24W	1	1.55	0.26	5169		
Source Flux	3230lm	2	3.10	0.51	1292		
Fixture Flux	2684lm	3	4.65	0.77	574		
Efficacy	112lm/W	4	6.21	1.02	323		
TS1088	Imax=1600cd/klm	Imax	5169cd	5	7.76	1.28	207



3000K		H(m)	D1(m)	D2(m)	Emax(lx)		
Ra80		76°	15°				
Fixture Power	24W	1	1.55	0.26	5505		
Source Flux	3440lm	2	3.10	0.51	1376		
Fixture Flux	2858lm	3	4.65	0.77	612		
Efficacy	119lm/W	4	6.21	1.02	344		
TS1088	Imax=1600cd/klm	Imax	5505cd	5	7.76	1.28	220

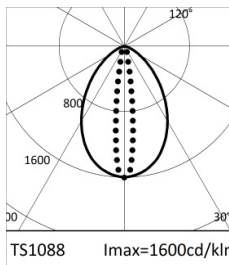

3500K		H(m)	D1(m)	D2(m)	Emax(lx)		
Ra80		76°	15°				
Fixture Power	24W	1	1.55	0.26	5633		
Source Flux	3520lm	2	3.10	0.51	1408		
Fixture Flux	2924lm	3	4.65	0.77	626		
Efficacy	122lm/W	4	6.21	1.02	352		
TS1088	Imax=1600cd/klm	Imax	5633cd	5	7.76	1.28	225

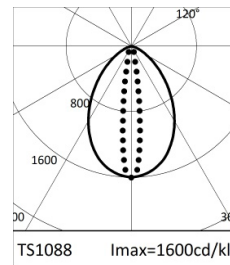

4000K		H(m)	D1(m)	D2(m)	Emax(lx)		
Ra80		76°	15°				
Fixture Power	24W	1	1.55	0.26	5761		
Source Flux	3600lm	2	3.10	0.51	1440		
Fixture Flux	2991lm	3	4.65	0.77	640		
Efficacy	125lm/W	4	6.21	1.02	360		
TS1088	Imax=1600cd/klm	Imax	5761cd	5	7.76	1.28	230

### 36" WALL GRAZER



2700K		H(m)	D1(m)	D2(m)	Emax(lx)		
Ra80		76°	15°				
Fixture Power	36W	1	1.55	0.26	7755		
Source Flux	4845lm	2	3.10	0.51	1939		
Fixture Flux	4026lm	3	4.65	0.77	862		
Efficacy	112lm/W	4	6.21	1.02	485		
TS1089	Imax=1601cd/klm	Imax	7755cd	5	7.76	1.28	310



3000K		H(m)	D1(m)	D2(m)	Emax(lx)		
Ra80		76°	15°				
Fixture Power	36W	1	1.55	0.26	8259		
Source Flux	5160lm	2	3.10	0.51	2065		
Fixture Flux	4288lm	3	4.65	0.77	918		
Efficacy	119lm/W	4	6.21	1.02	516		
TS1089	Imax=1601cd/klm	Imax	8259cd	5	7.76	1.28	330

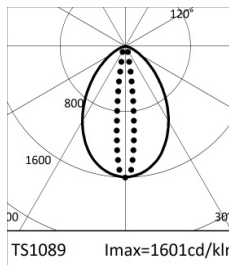

3500K		H(m)	D1(m)	D2(m)	Emax(lx)		
Ra80		76°	15°				
Fixture Power	36W	1	1.55	0.26	8451		
Source Flux	5280lm	2	3.10	0.51	2113		
Fixture Flux	4388lm	3	4.65	0.77	939		
Efficacy	122lm/W	4	6.21	1.02	528		
TS1089	Imax=1601cd/klm	Imax	8451cd	5	7.76	1.28	338



4000K		H(m)	D1(m)	D2(m)	Emax(lx)		
Ra80		76°	15°				
Fixture Power	36W	1	1.55	0.26	8643		
Source Flux	5400lm	2	3.10	0.51	2161		
Fixture Flux	4487lm	3	4.65	0.77	960		
Efficacy	125lm/W	4	6.21	1.02	540		
TS1089	Imax=1601cd/klm	Imax	8643cd	5	7.76	1.28	346

### 48" WALL GRAZER



2700K		H(m)	D1(m)	D2(m)	Emax(lx)		
Ra80		76°	15°				
Fixture Power	48W	1	1.55	0.26	10340		
Source Flux	6460lm	2	3.10	0.51	2585		
Fixture Flux	5368lm	3	4.65	0.77	1149		
Efficacy	112lm/W	4	6.21	1.02	646		
TS1089	Imax=1601cd/klm	Imax	10340cd	5	7.76	1.28	414

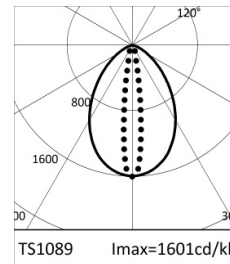

3000K		H(m)	D1(m)	D2(m)	Emax(lx)		
Ra80		76°	15°				
Fixture Power	48W	1	1.55	0.26	11012		
Source Flux	6880lm	2	3.10	0.51	2753		
Fixture Flux	5717lm	3	4.65	0.77	1224		
Efficacy	119lm/W	4	6.21	1.02	688		
TS1089	Imax=1601cd/klm	Imax	11012cd	5	7.76	1.28	440

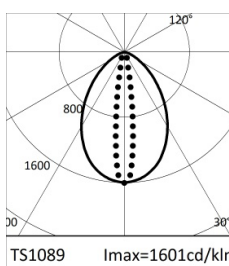

3500K		H(m)	D1(m)	D2(m)	Emax(lx)		
Ra80		76°	15°				
Fixture Power	48W	1	1.55	0.26	11268		
Source Flux	7040lm	2	3.10	0.51	2817		
Fixture Flux	5850lm	3	4.65	0.77	1252		
Efficacy	122lm/W	4	6.21	1.02	704		
TS1089	Imax=1601cd/klm	Imax	11268cd	5	7.76	1.28	451

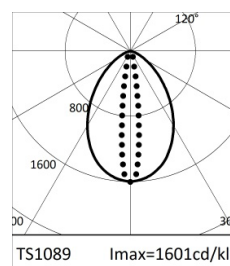

4000K		H(m)	D1(m)	D2(m)	Emax(lx)		
Ra80		76°	15°				
Fixture Power	48W	1	1.55	0.26	11524		
Source Flux	7200lm	2	3.10	0.51	2881		
Fixture Flux	5983lm	3	4.65	0.77	1280		
Efficacy	125lm/W	4	6.21	1.02	720		
TS1089	Imax=1601cd/klm	Imax	11524cd	5	7.76	1.28	461

# JEDI COMPACT REMOTE

## PHOTOMETRY

IES FILES WATTAGE AND EFFICIENCY CALCULATIONS BASED WITH SUPPLIED DRIVER

### 12" FLOOD

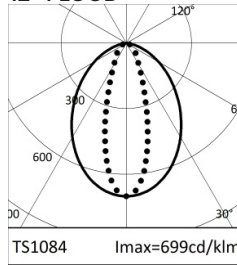

2700K		H(m)	D1(m)	D2(m)	Emax(lx)
Ra80		85°	32°		
Fixture Power	12W	1	1.84	0.57	1129
Source Flux	1615lm	2	3.68	1.14	282
Fixture Flux	1207lm	3	5.52	1.70	125
Efficacy	101lm/W	4	7.36	2.27	71
TS1084	I <sub>max</sub> =699cd/klm	I <sub>max</sub>	1129cd	5	9.20 2.84 45

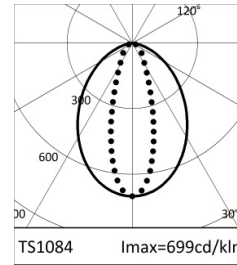

3000K		H(m)	D1(m)	D2(m)	Emax(lx)
Ra80		85°	32°		
Fixture Power	12W	1	1.84	0.57	1203
Source Flux	1720lm	2	3.68	1.14	301
Fixture Flux	1285lm	3	5.52	1.70	134
Efficacy	107lm/W	4	7.36	2.27	75
TS1084	I <sub>max</sub> =699cd/klm	I <sub>max</sub>	1203cd	5	9.20 2.84 48



3500K		H(m)	D1(m)	D2(m)	Emax(lx)
Ra80		85°	32°		
Fixture Power	12W	1	1.84	0.57	1231
Source Flux	1760lm	2	3.68	1.14	308
Fixture Flux	1315lm	3	5.52	1.70	137
Efficacy	110lm/W	4	7.36	2.27	77
TS1084	I <sub>max</sub> =699cd/klm	I <sub>max</sub>	1231cd	5	9.20 2.84 49



4000K		H(m)	D1(m)	D2(m)	Emax(lx)
Ra80		85°	32°		
Fixture Power	12W	1	1.84	0.57	1259
Source Flux	1800lm	2	3.68	1.14	315
Fixture Flux	1345lm	3	5.52	1.70	140
Efficacy	112lm/W	4	7.36	2.27	79
TS1084	I <sub>max</sub> =699cd/klm	I <sub>max</sub>	1259cd	5	9.20 2.84 50

### 24" FLOOD

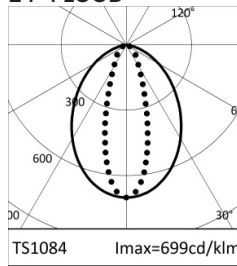

2700K		H(m)	D1(m)	D2(m)	Emax(lx)
Ra80		85°	32°		
Fixture Power	24W	1	1.84	0.57	2259
Source Flux	3230lm	2	3.68	1.14	565
Fixture Flux	2413lm	3	5.52	1.70	251
Efficacy	101lm/W	4	7.36	2.27	141
TS1084	I <sub>max</sub> =699cd/klm	I <sub>max</sub>	2259cd	5	9.20 2.84 90

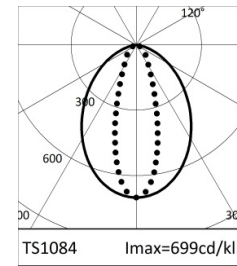

3000K		H(m)	D1(m)	D2(m)	Emax(lx)
Ra80		85°	32°		
Fixture Power	24W	1	1.84	0.57	2406
Source Flux	3440lm	2	3.68	1.14	601
Fixture Flux	2570lm	3	5.52	1.70	267
Efficacy	107lm/W	4	7.36	2.27	150
TS1084	I <sub>max</sub> =699cd/klm	I <sub>max</sub>	2406cd	5	9.20 2.84 96

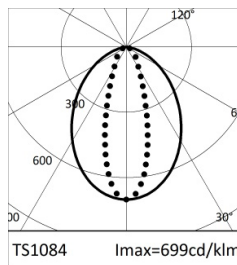

3500K		H(m)	D1(m)	D2(m)	Emax(lx)
Ra80		85°	32°		
Fixture Power	24W	1	1.84	0.57	2462
Source Flux	3520lm	2	3.68	1.14	615
Fixture Flux	2630lm	3	5.52	1.70	274
Efficacy	110lm/W	4	7.36	2.27	154
TS1084	I <sub>max</sub> =699cd/klm	I <sub>max</sub>	2462cd	5	9.20 2.84 98

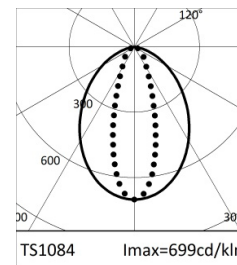

4000K		H(m)	D1(m)	D2(m)	Emax(lx)
Ra80		85°	32°		
Fixture Power	24W	1	1.84	0.57	2518
Source Flux	3600lm	2	3.68	1.14	629
Fixture Flux	2690lm	3	5.52	1.70	280
Efficacy	112lm/W	4	7.36	2.27	157
TS1084	I <sub>max</sub> =699cd/klm	I <sub>max</sub>	2518cd	5	9.20 2.84 101

### 36" FLOOD

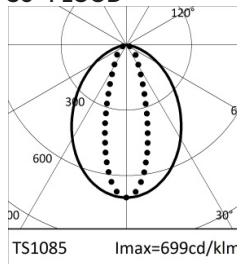

2700K		H(m)	D1(m)	D2(m)	Emax(lx)
Ra80		85°	32°		
Fixture Power	36W	1	1.84	0.57	3389
Source Flux	4845lm	2	3.68	1.14	847
Fixture Flux	3620lm	3	5.52	1.70	377
Efficacy	101lm/W	4	7.36	2.27	212
TS1085	I <sub>max</sub> =699cd/klm	I <sub>max</sub>	3389cd	5	9.20 2.84 136



3000K		H(m)	D1(m)	D2(m)	Emax(lx)
Ra80		85°	32°		
Fixture Power	36W	1	1.84	0.57	3609
Source Flux	5160lm	2	3.68	1.14	902
Fixture Flux	3856lm	3	5.52	1.70	401
Efficacy	107lm/W	4	7.36	2.27	226
TS1085	I <sub>max</sub> =699cd/klm	I <sub>max</sub>	3609cd	5	9.20 2.84 144



3500K		H(m)	D1(m)	D2(m)	Emax(lx)
Ra80		85°	32°		
Fixture Power	36W	1	1.84	0.57	3693
Source Flux	5280lm	2	3.68	1.14	923
Fixture Flux	3945lm	3	5.52	1.70	410
Efficacy	110lm/W	4	7.36	2.27	231
TS1085	I <sub>max</sub> =699cd/klm	I <sub>max</sub>	3693cd	5	9.20 2.84 148

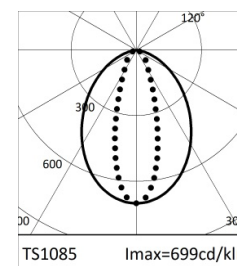

4000K		H(m)	D1(m)	D2(m)	Emax(lx)
Ra80		85°	32°		
Fixture Power	36W	1	1.84	0.57	3777
Source Flux	5400lm	2	3.68	1.14	944
Fixture Flux	4035lm	3	5.52	1.70	420
Efficacy	112lm/W	4	7.36	2.27	236
TS1085	I <sub>max</sub> =699cd/klm	I <sub>max</sub>	3777cd	5	9.20 2.84 151

# JEDI COMPACT REMOTE

## PHOTOMETRY

IES FILES WATTAGE AND EFFICIENCY CALCULATIONS BASED WITH SUPPLIED DRIVER

### 48" FLOOD



2700K		H(m)	D1(m)	D2(m)	Emax(lx)
Ra80		85°	32°		
Fixture Power	48W	1	1.84	0.57	4518
Source Flux	6460lm	2	3.68	1.14	1130
Fixture Flux	4827lm	3	5.52	1.70	502
Efficacy	101lm/W	4	7.36	2.27	282
TS1085	I <sub>max</sub> =699cd/klm	I <sub>max</sub>	4518cd	5	9.20 2.84 181

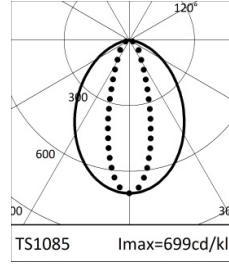

3000K		H(m)	D1(m)	D2(m)	Emax(lx)
Ra80		85°	32°		
Fixture Power	48W	1	1.84	0.57	4812
Source Flux	6880lm	2	3.68	1.14	1203
Fixture Flux	5141lm	3	5.52	1.70	535
Efficacy	107lm/W	4	7.36	2.27	301
TS1085	I <sub>max</sub> =699cd/klm	I <sub>max</sub>	4812cd	5	9.20 2.84 192

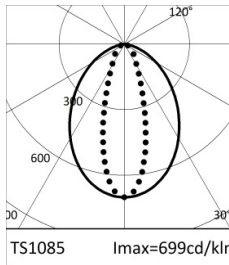

3500K		H(m)	D1(m)	D2(m)	Emax(lx)
Ra80		85°	32°		
Fixture Power	48W	1	1.84	0.57	4924
Source Flux	7040lm	2	3.68	1.14	1231
Fixture Flux	5260lm	3	5.52	1.70	547
Efficacy	110lm/W	4	7.36	2.27	308
TS1085	I <sub>max</sub> =699cd/klm	I <sub>max</sub>	4924cd	5	9.20 2.84 197

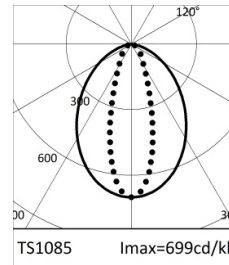

4000K		H(m)	D1(m)	D2(m)	Emax(lx)
Ra80		85°	32°		
Fixture Power	48W	1	1.84	0.57	5036
Source Flux	7200lm	2	3.68	1.14	1259
Fixture Flux	5380lm	3	5.52	1.70	560
Efficacy	112lm/W	4	7.36	2.27	315
TS1085	I <sub>max</sub> =699cd/klm	I <sub>max</sub>	5036cd	5	9.20 2.84 201

### 12" WALL WASHER (WITH LOUVER)

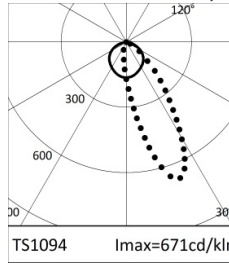

2700K		H(m)	D1(m)	D2(m)	Emax(lx)
Ra80		116°	62°		
Fixture Power	12W	1	3.17	1.49	901
Source Flux	1615lm	2	6.35	2.97	225
Fixture Flux	916lm	3	9.52	4.46	100
Efficacy	76lm/W	4	12.70	5.95	56
TS1094	I <sub>max</sub> =671cd/klm	I <sub>max</sub>	1083cd	5	15.87 7.43 36

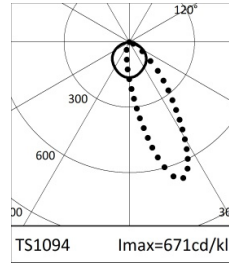

3000K		H(m)	D1(m)	D2(m)	Emax(lx)
Ra80		116°	62°		
Fixture Power	12W	1	3.17	1.49	960
Source Flux	1720lm	2	6.35	2.97	240
Fixture Flux	975lm	3	9.52	4.46	107
Efficacy	81lm/W	4	12.70	5.95	60
TS1094	I <sub>max</sub> =671cd/klm	I <sub>max</sub>	1153cd	5	15.87 7.43 38



3500K		H(m)	D1(m)	D2(m)	Emax(lx)
Ra80		116°	62°		
Fixture Power	12W	1	3.17	1.49	982
Source Flux	1760lm	2	6.35	2.97	245
Fixture Flux	998lm	3	9.52	4.46	109
Efficacy	83lm/W	4	12.70	5.95	61
TS1094	I <sub>max</sub> =671cd/klm	I <sub>max</sub>	1180cd	5	15.87 7.43 39



4000K		H(m)	D1(m)	D2(m)	Emax(lx)
Ra80		116°	62°		
Fixture Power	12W	1	3.17	1.49	1004
Source Flux	1800lm	2	6.35	2.97	251
Fixture Flux	1021lm	3	9.52	4.46	112
Efficacy	85lm/W	4	12.70	5.95	63
TS1094	I <sub>max</sub> =671cd/klm	I <sub>max</sub>	1207cd	5	15.87 7.43 40

### 24" WALL WASHER (WITH LOUVER)



2700K		H(m)	D1(m)	D2(m)	Emax(lx)
Ra80		116°	62°		
Fixture Power	24W	1	3.17	1.49	1802
Source Flux	3230lm	2	6.35	2.97	450
Fixture Flux	1831lm	3	9.52	4.46	200
Efficacy	76lm/W	4	12.70	5.95	113
TS1094	I <sub>max</sub> =671cd/klm	I <sub>max</sub>	2166cd	5	15.87 7.43 72



3000K		H(m)	D1(m)	D2(m)	Emax(lx)
Ra80		116°	62°		
Fixture Power	24W	1	3.17	1.49	1919
Source Flux	3440lm	2	6.35	2.97	480
Fixture Flux	1950lm	3	9.52	4.46	213
Efficacy	81lm/W	4	12.70	5.95	120
TS1094	I <sub>max</sub> =671cd/klm	I <sub>max</sub>	2307cd	5	15.87 7.43 77

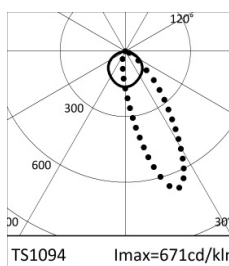

3500K		H(m)	D1(m)	D2(m)	Emax(lx)
Ra80		116°	62°		
Fixture Power	24W	1	3.17	1.49	1964
Source Flux	3520lm	2	6.35	2.97	491
Fixture Flux	1996lm	3	9.52	4.46	218
Efficacy	83lm/W	4	12.70	5.95	123
TS1094	I <sub>max</sub> =671cd/klm	I <sub>max</sub>	2360cd	5	15.87 7.43 79

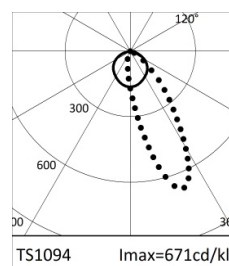

4000K		H(m)	D1(m)	D2(m)	Emax(lx)
Ra80		116°	62°		
Fixture Power	24W	1	3.17	1.49	2008
Source Flux	3600lm	2	6.35	2.97	502
Fixture Flux	2041lm	3	9.52	4.46	223
Efficacy	85lm/W	4	12.70	5.95	126
TS1094	I <sub>max</sub> =671cd/klm	I <sub>max</sub>	2414cd	5	15.87 7.43 80

# JEDI COMPACT REMOTE

## PHOTOMETRY

IES FILES WATTAGE AND EFFICIENCY CALCULATIONS BASED WITH SUPPLIED DRIVER

### 36" WALL WASHER (WITH LOUVER)

	2700K	H(m)	D1(m)	D2(m)	Emax(lx)		
	Ra80		116°	62°			
	Fixture Power	36W	1	3.17	1.49	2703	
	Source Flux	4845lm	2	6.35	2.97	676	
	Fixture Flux	2747lm	3	9.52	4.46	300	
	Efficacy	76lm/W	4	12.70	5.95	169	
TS1095	Imax=671cd/klm	Imax	3249cd	5	15.87	7.43	108

	3000K	H(m)	D1(m)	D2(m)	Emax(lx)		
	Ra80		116°	62°			
	Fixture Power	36W	1	3.17	1.49	2879	
	Source Flux	5160lm	2	6.35	2.97	720	
	Fixture Flux	2926lm	3	9.52	4.46	320	
	Efficacy	81lm/W	4	12.70	5.95	180	
TS1095	Imax=671cd/klm	Imax	3460cd	5	15.87	7.43	115

	3500K	H(m)	D1(m)	D2(m)	Emax(lx)		
	Ra80		116°	62°			
	Fixture Power	36W	1	3.17	1.49	2946	
	Source Flux	5280lm	2	6.35	2.97	736	
	Fixture Flux	2994lm	3	9.52	4.46	327	
	Efficacy	83lm/W	4	12.70	5.95	184	
TS1095	Imax=671cd/klm	Imax	3541cd	5	15.87	7.43	118

	4000K	H(m)	D1(m)	D2(m)	Emax(lx)		
	Ra80		116°	62°			
	Fixture Power	36W	1	3.17	1.49	3012	
	Source Flux	5400lm	2	6.35	2.97	753	
	Fixture Flux	3062lm	3	9.52	4.46	335	
	Efficacy	85lm/W	4	12.70	5.95	188	
TS1095	Imax=671cd/klm	Imax	3621cd	5	15.87	7.43	120

### 48" WALL WASHER (WITH LOUVER)

	2700K	H(m)	D1(m)	D2(m)	Emax(lx)		
	Ra80		116°	62°			
	Fixture Power	48W	1	3.17	1.49	3604	
	Source Flux	6460lm	2	6.35	2.97	901	
	Fixture Flux	3663lm	3	9.52	4.46	400	
	Efficacy	76lm/W	4	12.70	5.95	225	
TS1095	Imax=671cd/klm	Imax	4332cd	5	15.87	7.43	144

	3000K	H(m)	D1(m)	D2(m)	Emax(lx)		
	Ra80		116°	62°			
	Fixture Power	48W	1	3.17	1.49	3838	
	Source Flux	6880lm	2	6.35	2.97	960	
	Fixture Flux	3901lm	3	9.52	4.46	426	
	Efficacy	81lm/W	4	12.70	5.95	240	
TS1095	Imax=671cd/klm	Imax	4613cd	5	15.87	7.43	154

	3500K	H(m)	D1(m)	D2(m)	Emax(lx)		
	Ra80		116°	62°			
	Fixture Power	48W	1	3.17	1.49	3927	
	Source Flux	7040lm	2	6.35	2.97	982	
	Fixture Flux	3992lm	3	9.52	4.46	436	
	Efficacy	83lm/W	4	12.70	5.95	245	
TS1095	Imax=671cd/klm	Imax	4721cd	5	15.87	7.43	157

	4000K	H(m)	D1(m)	D2(m)	Emax(lx)		
	Ra80		116°	62°			
	Fixture Power	48W	1	3.17	1.49	4017	
	Source Flux	7200lm	2	6.35	2.97	1004	
	Fixture Flux	4082lm	3	9.52	4.46	446	
	Efficacy	85lm/W	4	12.70	5.95	251	
TS1095	Imax=671cd/klm	Imax	4828cd	5	15.87	7.43	161

### 12" WALL GRAZER (WITH LOUVER)

	2700K	H(m)	D1(m)	D2(m)	Emax(lx)		
	Ra80		80°	13°			
	Fixture Power	12W	1	1.68	0.23	1787	
	Source Flux	1615lm	2	3.36	0.46	447	
	Fixture Flux	856lm	3	5.04	0.68	199	
	Efficacy	71lm/W	4	6.72	0.91	112	
TS1090	Imax=1106cd/klm	Imax	1787cd	5	8.40	1.14	71

	3000K	H(m)	D1(m)	D2(m)	Emax(lx)		
	Ra80		80°	13°			
	Fixture Power	12W	1	1.68	0.23	1903	
	Source Flux	1720lm	2	3.36	0.46	476	
	Fixture Flux	912lm	3	5.04	0.68	211	
	Efficacy	76lm/W	4	6.72	0.91	119	
TS1090	Imax=1106cd/klm	Imax	1903cd	5	8.40	1.14	76

	3500K	H(m)	D1(m)	D2(m)	Emax(lx)		
	Ra80		80°	13°			
	Fixture Power	12W	1	1.68	0.23	1947	
	Source Flux	1760lm	2	3.36	0.46	487	
	Fixture Flux	933lm	3	5.04	0.68	216	
	Efficacy	78lm/W	4	6.72	0.91	122	
TS1090	Imax=1106cd/klm	Imax	1947cd	5	8.40	1.14	78

	4000K	H(m)	D1(m)	D2(m)	Emax(lx)		
	Ra80		80°	13°			
	Fixture Power	12W	1	1.68	0.23	1991	
	Source Flux	1800lm	2	3.36	0.46	498	
	Fixture Flux	954lm	3	5.04	0.68	221	
	Efficacy	80lm/W	4	6.72	0.91	124	
TS1090	Imax=1106cd/klm	Imax	1991cd	5	8.40	1.14	80

# JEDI COMPACT REMOTE

## PHOTOMETRY

IES FILES WATTAGE AND EFFICIENCY CALCULATIONS BASED WITH SUPPLIED DRIVER

### 24" WALL GRAZER (WITH LOUVER)



2700K		H(m)	D1(m)	D2(m)	E <sub>max</sub> (lx)
Ra80		80°	13°		
Fixture Power	24W	1	1.68	0.23	3573
Source Flux	3230lm	2	3.36	0.46	893
Fixture Flux	1712lm	3	5.04	0.68	397
Efficacy	71lm/W	4	6.72	0.91	223
TS1090	I <sub>max</sub> =1106cd/klm	I <sub>max</sub>	3573cd	5	8.40 1.14 143

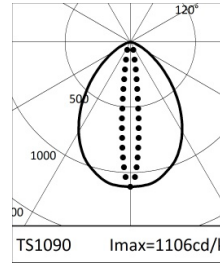

3000K		H(m)	D1(m)	D2(m)	E <sub>max</sub> (lx)
Ra80		80°	13°		
Fixture Power	24W	1	1.68	0.23	3805
Source Flux	3440lm	2	3.36	0.46	951
Fixture Flux	1824lm	3	5.04	0.68	423
Efficacy	76lm/W	4	6.72	0.91	238
TS1090	I <sub>max</sub> =1106cd/klm	I <sub>max</sub>	3805cd	5	8.40 1.14 152

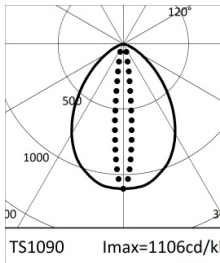

3500K		H(m)	D1(m)	D2(m)	E <sub>max</sub> (lx)
Ra80		80°	13°		
Fixture Power	24W	1	1.68	0.23	3894
Source Flux	3520lm	2	3.36	0.46	973
Fixture Flux	1866lm	3	5.04	0.68	433
Efficacy	78lm/W	4	6.72	0.91	243
TS1090	I <sub>max</sub> =1106cd/klm	I <sub>max</sub>	3894cd	5	8.40 1.14 156

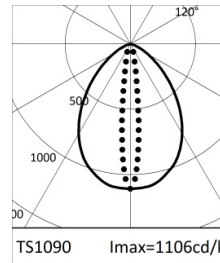

4000K		H(m)	D1(m)	D2(m)	E <sub>max</sub> (lx)
Ra80		80°	13°		
Fixture Power	24W	1	1.68	0.23	3982
Source Flux	3600lm	2	3.36	0.46	996
Fixture Flux	1908lm	3	5.04	0.68	442
Efficacy	80lm/W	4	6.72	0.91	249
TS1090	I <sub>max</sub> =1106cd/klm	I <sub>max</sub>	3982cd	5	8.40 1.14 159

### 36" WALL GRAZER (WITH LOUVER)



2700K		H(m)	D1(m)	D2(m)	E <sub>max</sub> (lx)
Ra80		80°	13°		
Fixture Power	36W	1	1.68	0.23	5359
Source Flux	4845lm	2	3.36	0.46	1340
Fixture Flux	2568lm	3	5.04	0.68	595
Efficacy	71lm/W	4	6.72	0.91	335
TS1091	I <sub>max</sub> =1106cd/klm	I <sub>max</sub>	5359cd	5	8.40 1.14 214

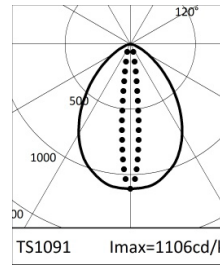

3000K		H(m)	D1(m)	D2(m)	E <sub>max</sub> (lx)
Ra80		80°	13°		
Fixture Power	36W	1	1.68	0.23	5707
Source Flux	5160lm	2	3.36	0.46	1427
Fixture Flux	2735lm	3	5.04	0.68	634
Efficacy	76lm/W	4	6.72	0.91	357
TS1091	I <sub>max</sub> =1106cd/klm	I <sub>max</sub>	5707cd	5	8.40 1.14 228

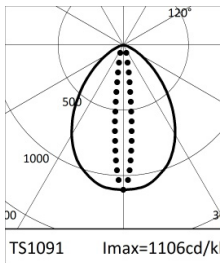

3500K		H(m)	D1(m)	D2(m)	E <sub>max</sub> (lx)
Ra80		80°	13°		
Fixture Power	36W	1	1.68	0.23	5840
Source Flux	5280lm	2	3.36	0.46	1460
Fixture Flux	2798lm	3	5.04	0.68	649
Efficacy	78lm/W	4	6.72	0.91	365
TS1091	I <sub>max</sub> =1106cd/klm	I <sub>max</sub>	5840cd	5	8.40 1.14 234



4000K		H(m)	D1(m)	D2(m)	E <sub>max</sub> (lx)
Ra80		80°	13°		
Fixture Power	36W	1	1.68	0.23	5973
Source Flux	5400lm	2	3.36	0.46	1493
Fixture Flux	2862lm	3	5.04	0.68	664
Efficacy	80lm/W	4	6.72	0.91	373
TS1091	I <sub>max</sub> =1106cd/klm	I <sub>max</sub>	5973cd	5	8.40 1.14 239

### 48" WALL GRAZER (WITH LOUVER)



2700K		H(m)	D1(m)	D2(m)	E <sub>max</sub> (lx)
Ra80		80°	13°		
Fixture Power	48W	1	1.68	0.23	7145
Source Flux	6460lm	2	3.36	0.46	1786
Fixture Flux	3424lm	3	5.04	0.68	794
Efficacy	71lm/W	4	6.72	0.91	447
TS1091	I <sub>max</sub> =1106cd/klm	I <sub>max</sub>	7145cd	5	8.40 1.14 286



3000K		H(m)	D1(m)	D2(m)	E <sub>max</sub> (lx)
Ra80		80°	13°		
Fixture Power	48W	1	1.68	0.23	7609
Source Flux	6880lm	2	3.36	0.46	1902
Fixture Flux	3646lm	3	5.04	0.68	845
Efficacy	76lm/W	4	6.72	0.91	476
TS1091	I <sub>max</sub> =1106cd/klm	I <sub>max</sub>	7609cd	5	8.40 1.14 304



3500K		H(m)	D1(m)	D2(m)	E <sub>max</sub> (lx)
Ra80		80°	13°		
Fixture Power	48W	1	1.68	0.23	7786
Source Flux	7040lm	2	3.36	0.46	1947
Fixture Flux	3731lm	3	5.04	0.68	865
Efficacy	78lm/W	4	6.72	0.91	487
TS1091	I <sub>max</sub> =1106cd/klm	I <sub>max</sub>	7786cd	5	8.40 1.14 311

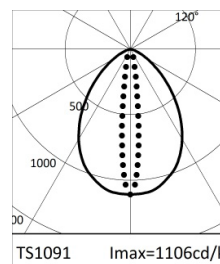

4000K		H(m)	D1(m)	D2(m)	E <sub>max</sub> (lx)
Ra80		80°	13°		
Fixture Power	48W	1	1.68	0.23	7963
Source Flux	7200lm	2	3.36	0.46	1991
Fixture Flux	3816lm	3	5.04	0.68	885
Efficacy	80lm/W	4	6.72	0.91	498
TS1091	I <sub>max</sub> =1106cd/klm	I <sub>max</sub>	7963cd	5	8.40 1.14 319

# JEDI COMPACT REMOTE

## PHOTOMETRY

IES FILES WATTAGE AND EFFICIENCY CALCULATIONS BASED WITH SUPPLIED DRIVER

### 12" FLOOD (WITH LOUVER)

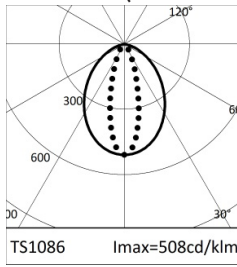

2700K		H(m)	D1(m)	D2(m)	Emax(lx)		
Ra80		86°	29°				
Fixture Power	12W	1	1.86	0.52	820		
Source Flux	1615lm	2	3.71	1.05	205		
Fixture Flux	706lm	3	5.57	1.57	91		
Efficacy	59lm/W	4	7.42	2.09	51		
TS1086	I <sub>max</sub> =508cd/klm	I <sub>max</sub>	820cd	5	9.28	2.62	33

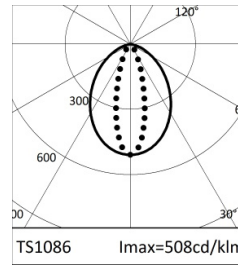

3000K		H(m)	D1(m)	D2(m)	Emax(lx)		
Ra80		86°	29°				
Fixture Power	12W	1	1.86	0.52	873		
Source Flux	1720lm	2	3.71	1.05	218		
Fixture Flux	752lm	3	5.57	1.57	97		
Efficacy	63lm/W	4	7.42	2.09	55		
TS1086	I <sub>max</sub> =508cd/klm	I <sub>max</sub>	873cd	5	9.28	2.62	35



3500K		H(m)	D1(m)	D2(m)	Emax(lx)		
Ra80		86°	29°				
Fixture Power	12W	1	1.86	0.52	894		
Source Flux	1760lm	2	3.71	1.05	223		
Fixture Flux	769lm	3	5.57	1.57	99		
Efficacy	64lm/W	4	7.42	2.09	56		
TS1086	I <sub>max</sub> =508cd/klm	I <sub>max</sub>	894cd	5	9.28	2.62	36

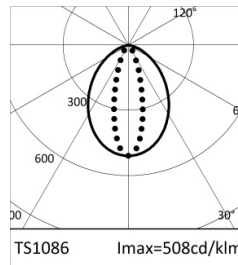

4000K		H(m)	D1(m)	D2(m)	Emax(lx)		
Ra80		86°	29°				
Fixture Power	12W	1	1.86	0.52	914		
Source Flux	1800lm	2	3.71	1.05	229		
Fixture Flux	787lm	3	5.57	1.57	102		
Efficacy	66lm/W	4	7.42	2.09	57		
TS1086	I <sub>max</sub> =508cd/klm	I <sub>max</sub>	914cd	5	9.28	2.62	37

### 24" FLOOD (WITH LOUVER)

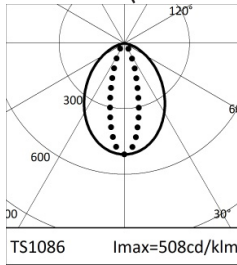

2700K		H(m)	D1(m)	D2(m)	Emax(lx)		
Ra80		86°	29°				
Fixture Power	24W	1	1.86	0.52	1640		
Source Flux	3230lm	2	3.71	1.05	410		
Fixture Flux	1412lm	3	5.57	1.57	182		
Efficacy	59lm/W	4	7.42	2.09	103		
TS1086	I <sub>max</sub> =508cd/klm	I <sub>max</sub>	1640cd	5	9.28	2.62	66

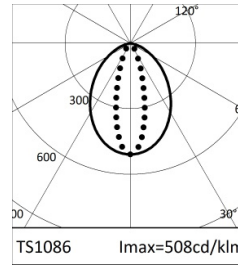

3000K		H(m)	D1(m)	D2(m)	Emax(lx)		
Ra80		86°	29°				
Fixture Power	24W	1	1.86	0.52	1747		
Source Flux	3440lm	2	3.71	1.05	437		
Fixture Flux	1503lm	3	5.57	1.57	194		
Efficacy	63lm/W	4	7.42	2.09	109		
TS1086	I <sub>max</sub> =508cd/klm	I <sub>max</sub>	1747cd	5	9.28	2.62	70

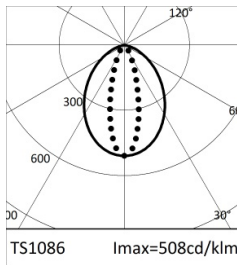

3500K		H(m)	D1(m)	D2(m)	Emax(lx)		
Ra80		86°	29°				
Fixture Power	24W	1	1.86	0.52	1788		
Source Flux	3520lm	2	3.71	1.05	447		
Fixture Flux	1538lm	3	5.57	1.57	199		
Efficacy	64lm/W	4	7.42	2.09	112		
TS1086	I <sub>max</sub> =508cd/klm	I <sub>max</sub>	1788cd	5	9.28	2.62	72



4000K		H(m)	D1(m)	D2(m)	Emax(lx)		
Ra80		86°	29°				
Fixture Power	24W	1	1.86	0.52	1828		
Source Flux	3600lm	2	3.71	1.05	457		
Fixture Flux	1573lm	3	5.57	1.57	203		
Efficacy	66lm/W	4	7.42	2.09	114		
TS1086	I <sub>max</sub> =508cd/klm	I <sub>max</sub>	1828cd	5	9.28	2.62	73

### 36" FLOOD (WITH LOUVER)

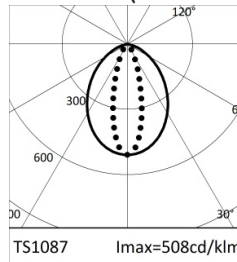

2700K		H(m)	D1(m)	D2(m)	Emax(lx)		
Ra80		86°	29°				
Fixture Power	36W	1	1.86	0.52	2460		
Source Flux	4845lm	2	3.71	1.05	615		
Fixture Flux	2117lm	3	5.57	1.57	273		
Efficacy	59lm/W	4	7.42	2.09	154		
TS1087	I <sub>max</sub> =508cd/klm	I <sub>max</sub>	2460cd	5	9.28	2.62	98



3000K		H(m)	D1(m)	D2(m)	Emax(lx)		
Ra80		86°	29°				
Fixture Power	36W	1	1.86	0.52	2620		
Source Flux	5160lm	2	3.71	1.05	655		
Fixture Flux	2255lm	3	5.57	1.57	291		
Efficacy	63lm/W	4	7.42	2.09	164		
TS1087	I <sub>max</sub> =508cd/klm	I <sub>max</sub>	2620cd	5	9.28	2.62	105

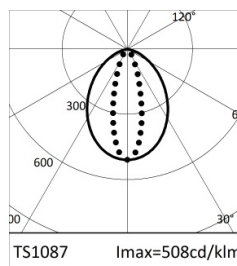

3500K		H(m)	D1(m)	D2(m)	Emax(lx)		
Ra80		86°	29°				
Fixture Power	36W	1	1.86	0.52	2681		
Source Flux	5280lm	2	3.71	1.05	670		
Fixture Flux	2307lm	3	5.57	1.57	298		
Efficacy	64lm/W	4	7.42	2.09	168		
TS1087	I <sub>max</sub> =508cd/klm	I <sub>max</sub>	2681cd	5	9.28	2.62	107



4000K		H(m)	D1(m)	D2(m)	Emax(lx)		
Ra80		86°	29°				
Fixture Power	36W	1	1.86	0.52	2742		
Source Flux	5400lm	2	3.71	1.05	686		
Fixture Flux	2360lm	3	5.57	1.57	305		
Efficacy	66lm/W	4	7.42	2.09	171		
TS1087	I <sub>max</sub> =508cd/klm	I <sub>max</sub>	2742cd	5	9.28	2.62	110

# JEDI COMPACT REMOTE

## PHOTOMETRY

IES FILES WATTAGE AND EFFICIENCY CALCULATIONS BASED WITH SUPPLIED DRIVER

### 48" FLOOD (WITH LOUVER)

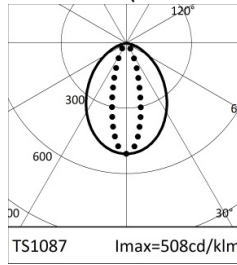

		2700K	H(m)	D1(m)	D2(m)	E <sub>max</sub> (lx)	
		Ra80		86°	29°		
Fixture Power	48W	1	1.86	0.52	3281		
Source Flux	6460lm	2	3.71	1.05	820		
Fixture Flux	2823lm	3	5.57	1.57	365		
Efficacy	59lm/W	4	7.42	2.09	205		
TS1087	I <sub>max</sub> =508cd/klm	I <sub>max</sub>	3281cd	5	9.28	2.62	131



		3000K	H(m)	D1(m)	D2(m)	E <sub>max</sub> (lx)	
		Ra80		86°	29°		
Fixture Power	48W	1	1.86	0.52	3494		
Source Flux	6880lm	2	3.71	1.05	873		
Fixture Flux	3007lm	3	5.57	1.57	388		
Efficacy	63lm/W	4	7.42	2.09	218		
TS1087	I <sub>max</sub> =508cd/klm	I <sub>max</sub>	3494cd	5	9.28	2.62	140



		3500K	H(m)	D1(m)	D2(m)	E <sub>max</sub> (lx)	
		Ra80		86°	29°		
Fixture Power	48W	1	1.86	0.52	3575		
Source Flux	7040lm	2	3.71	1.05	894		
Fixture Flux	3076lm	3	5.57	1.57	397		
Efficacy	64lm/W	4	7.42	2.09	223		
TS1087	I <sub>max</sub> =508cd/klm	I <sub>max</sub>	3575cd	5	9.28	2.62	143

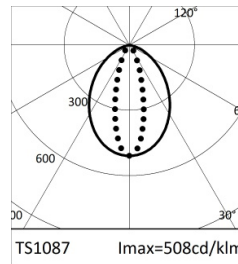

		4000K	H(m)	D1(m)	D2(m)	E <sub>max</sub> (lx)	
		Ra80		86°	29°		
Fixture Power	48W	1	1.86	0.52	3656		
Source Flux	7200lm	2	3.71	1.05	914		
Fixture Flux	3146lm	3	5.57	1.57	406		
Efficacy	66lm/W	4	7.42	2.09	229		
TS1087	I <sub>max</sub> =508cd/klm	I <sub>max</sub>	3656cd	5	9.28	2.62	146