

OZ 48V LARGE SURFACE/SUSPENSION PROFILE

Magnet Mounted Modular Light System

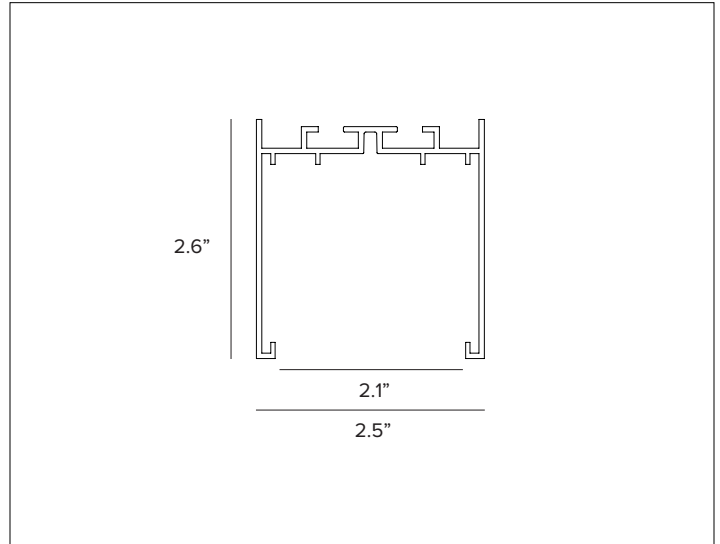
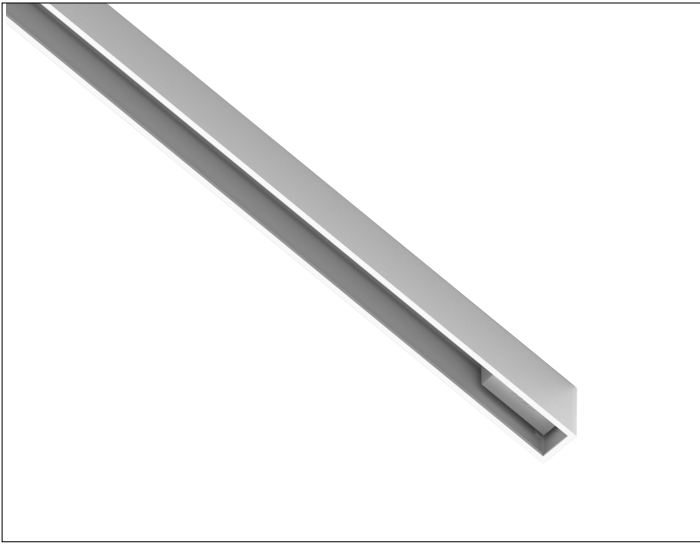

CONCEPT

Professional magnet mounted low voltage modular light system allowing for maximum application flexibility.

MECHANICAL CHARACTERISTICS

Dimensions	2.5"W x 2.6"H
Materials	Extruded painted aluminum profile.
Finish	<input type="radio"/> Plaster White <input checked="" type="radio"/> Deep Black
Functionality	Different mounting configurations are achievable using joint connectors that make it possible to build a simple or complex systems. To be completed with OZ 48V Power Rail for electrical connections.
Mounting	Ceiling or suspension for Lead / Stand Alone or Center / End profiles. Profile system configurations are achieved through optional joint connectors.
Weight	3.33ft L: 2.5lbs / 6.61ft L: 5lbs

WARRANTY

5 year limited warranty.

OZ 48V LARGE SURFACE/SUSPENSION PROFILE

SPECIFICATION INFORMATION



Ex: 1T7083 / 1T7095 / 1T7065

1 - PROFILE	2 - END CAP	3 - MOUNTING	4 - JOINT CONNECTOR	5 - COVERS
REQUIRED	REQUIRED	REQUIRED	OPTIONAL	OPTIONAL

Plaster White Finish Deep Black Finish

1 - PROFILE (REQUIRED)

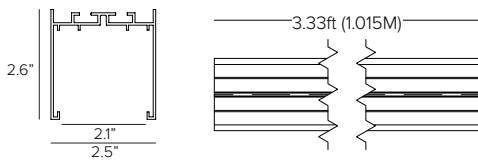

Field cuttable OZ LARGE surface/suspension aluminum profile for lead or standalone configurations.

Finish
 Part No. **1T7083** **1T7086**



Field cuttable OZ LARGE surface/suspension aluminum profile for lead or standalone configurations.

Finish
 Part No. **1T7084** **1T7087**

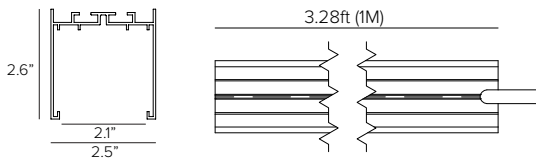

Field cuttable OZ LARGE surface/suspension aluminum profile for center and end configurations.

Finish
 Part No. **1T7077** **1T7080**

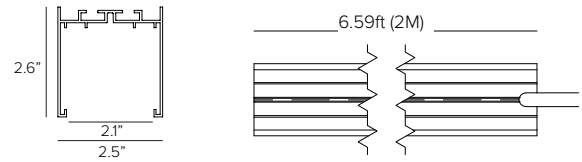

Field cuttable OZ LARGE surface/suspension aluminum profile for center and end configurations.

Finish
 Part No. **1T7078** **1T7081**

2 - END CAP (REQUIRED)

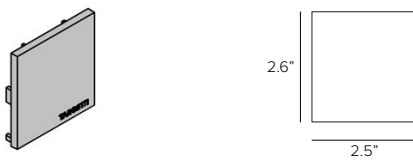

OZ LARGE surface/suspension end cap kit, 2pcs.

Finish
 Part No. **1T7095** **1T7096**

OZ 48V LARGE SURFACE/SUSPENSION PROFILE

3 - MOUNTING SYSTEM (REQUIRED)

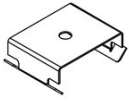

OZ surface profile installation clip, 1pc. Suggested 2pcs for 3ft (1M) L and 3pcs for 6.5ft (2M) L profiles.

Part No. **1T7065**



OZ suspension profile installation kit, includes 20ft L aircraft cable, 1pc. Suggested 2pcs for 3ft (1M) L and 3pcs for 6.5ft (2M) L profiles.

Part No. **1US7066**

4 - JOINT CONNECTORS (OPTIONAL)

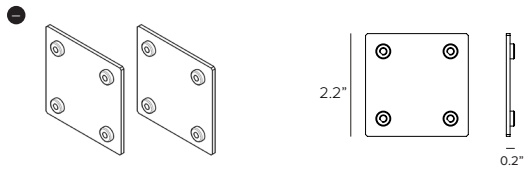

OZ surface/suspension profile linear joint connector kit, includes of 2pcs mechanical linear joints and 8pcs screws. Compatible with small and large suspended profiles.

Finish

Part No. **1T7064** **1T7097**



OZ LARGE surface/suspension profile L-joint connector.

Finish

Part No. **1T7089** **1T7092**

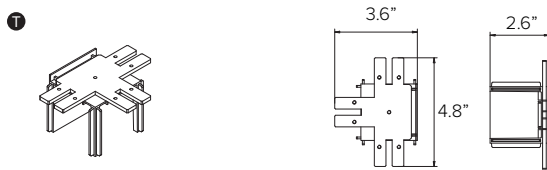

OZ LARGE surface/suspension profile T-joint connector.

Finish

Part No. **1T7090** **1T7093**

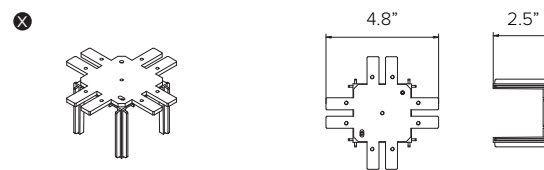

OZ LARGE surface/suspension profile X-joint connector.

Finish

Part No. **1T7091** **1T7094**

5 - COVER (OPTIONAL)

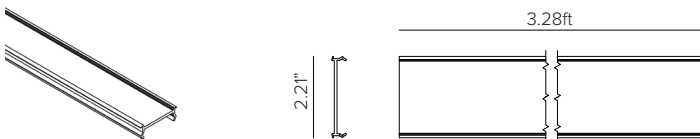

Field cuttable OZ LARGE surface/suspension cover.

Finish

Part No. **1T9599** **1T9601**

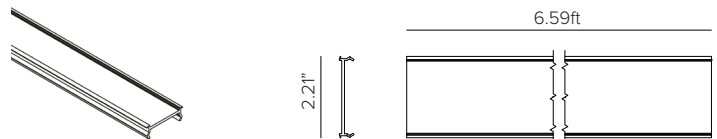

Field cuttable OZ LARGE surface/suspension cover.

Finish

Part No. **1T9600** **1T9602**

OZ 48V LARGE SURFACE/SUSPENSION PROFILE

INSTALLATION DIAGRAMS

NOTE: Max of 4 connectors (excluding power feed) or 30ft or power rail per individual power supply.

CEILING OR SUSPENSION INSTALLATION

OZ Power Rail + OZ Surface / Suspended Profile

