

OZ 48V SMALL RECESSED PROFILE

Magnet Mounted Modular Light System

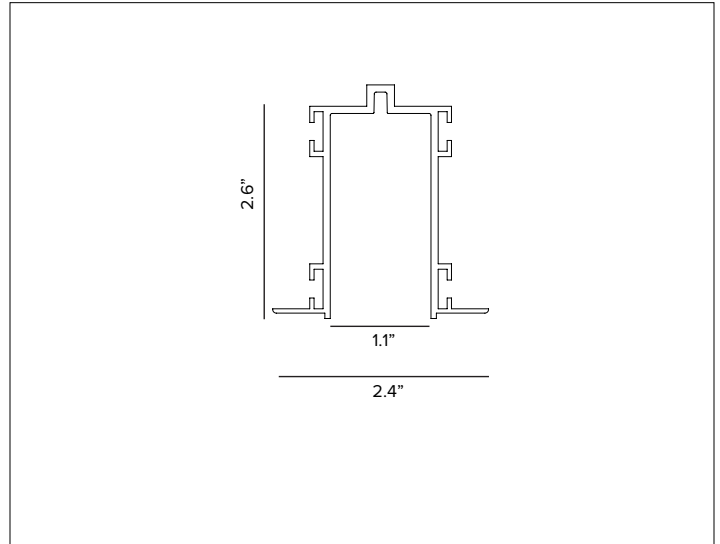

CONCEPT

Professional magnet mounted low voltage modular light system allowing for maximum application flexibility.

MECHANICAL CHARACTERISTICS

| | |
|----------------------|--|
| Dimensions | 2.4"W x 2.6"H |
| Materials | Extruded painted aluminum profile. |
| Finish | <input type="radio"/> Plaster White <input checked="" type="radio"/> Deep Black |
| Functionality | Different mounting configurations are achievable using joint connectors that make it possible to build a simple or complex systems. To be completed with OZ 48V Power Rail for electrical connections. |
| Mounting | Recessed flanged profile for use in Non-Airtight installations. Profile system configurations are achieved through optional joint connectors. |
| Weight | 3.28ft L: 2.5 lbs / 6.59ft L: 5 lbs |

WARRANTY

5 year limited warranty.

OZ 48V SMALL RECESSED PROFILE

SPECIFICATION INFORMATION

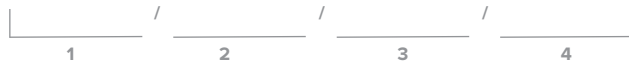

39Ex: 1T7031/1T7039/1T7043

| 1 - PROFILE | 2 - END CAP | 3 - MOUNTING | 4 - JOINT CONNECTOR |
|-----------------|-----------------|-----------------|---------------------|
| REQUIRED | REQUIRED | REQUIRED | OPTIONAL |

Plaster White Finish Deep Black Finish

1 - PROFILE (REQUIRED)

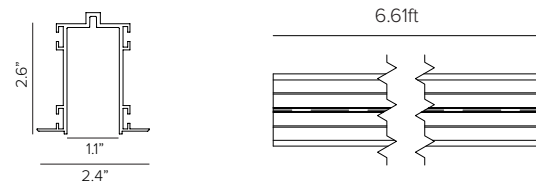
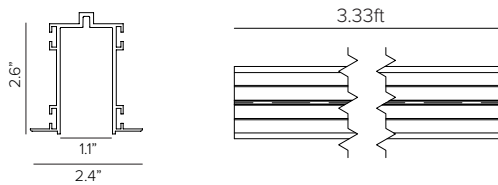

Field cuttable OZ SMALL recessed flanged aluminum profile.

Finish
 Part No. **1T7031** **1T7034**

Field cuttable OZ SMALL recessed flanged aluminum profile.

Finish
 Part No. **1T7032** **1T7035**

2 - END CAP (REQUIRED)

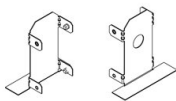

OZ SMALL recessed profile end cap kit, 2pcs.

Finish
 Part No. **1T7039** **1T7040**

3 - SUPPORT BRACKET (REQUIRED)



OZ SMALL recessed profile steel installation support bracket. Suggested 2pcs for 3.33ft L and 3pcs for 6.61ft L profiles.

Part No. **1T7043**

OZ 48V SMALL RECESSED PROFILE

4 - JOINT CONNECTORS (OPTIONAL)

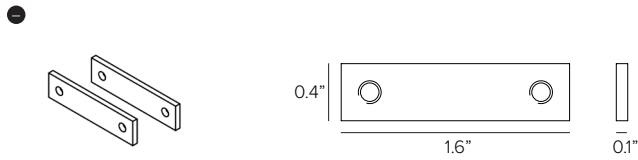

OZ recessed profile linear joint connector kit, includes 2pcs mechanical linear joints and 4pcs screws. Compatible with small and large profiles.

Part No. **117041**

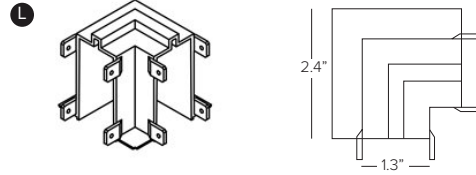

OZ SMALL recessed profile L-joint connector.

Finish

Part No. **117037**

117038

Plaster White Finish

Deep Black Finish

OZ 48V SMALL RECESSED PROFILE

INSTALLATION DIAGRAMS

NOTE: Max of 4 connectors (excluding power feed) or 30ft or power rail per individual power supply.

RECESSED INSTALLATION Power Rail + Recessed Profile

