

OZ 48V SMALL SURFACE/SUSPENSION PROFILE

Magnet Mounted Modular Light System

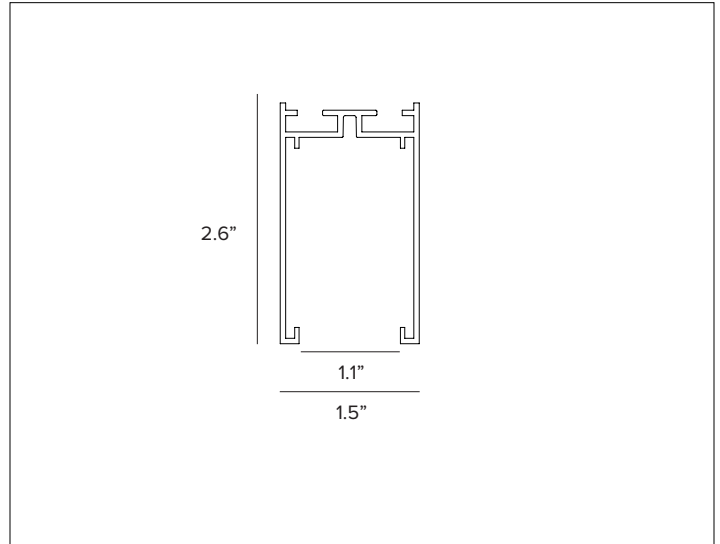
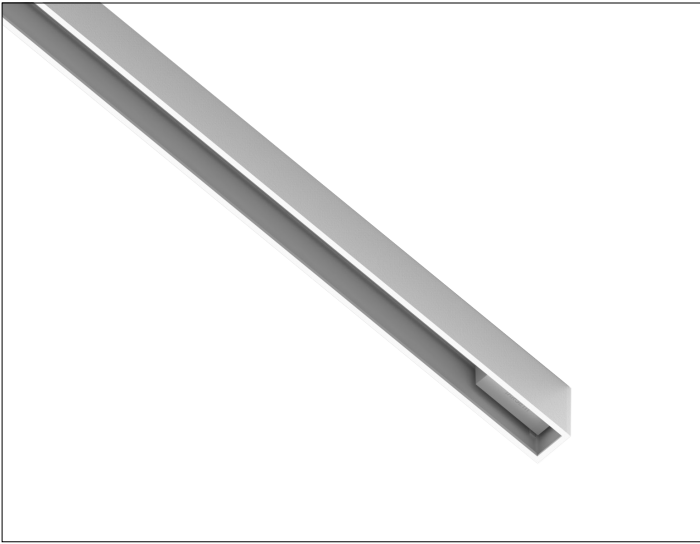

CONCEPT

Professional magnet mounted low voltage modular light system allowing for maximum application flexibility.

MECHANICAL CHARACTERISTICS

Dimensions	1.5"W x 2.6"H
Materials	Extruded painted aluminum profile.
Finish	<input type="radio"/> Plaster White <input checked="" type="radio"/> Deep Black
Functionality	Different mounting configurations are achievable using joint connectors that make it possible to build a simple or complex systems. To be completed with OZ 48V Power Rail for electrical connections.
Mounting	Ceiling or suspension for Lead / Stand Alone or Center / End profiles. Profile system configurations are achieved through optional joint connectors.
Weight	3.33ft L: 2lbs / 6.6ft L: 4lbs

WARRANTY

5 year limited warranty.

OZ 48V SMALL SURFACE/SUSPENSION PROFILE

SPECIFICATION INFORMATION



Ex: 1T7050 / 1T7062 / 1T7065

1 - PROFILE	2 - END CAP	3 - MOUNTING	4 - JOINT CONNECTOR	5 - COVER
REQUIRED	REQUIRED	REQUIRED	OPTIONAL	OPTIONAL

Plaster White Finish Deep Black Finish

1 - PROFILE (REQUIRED)

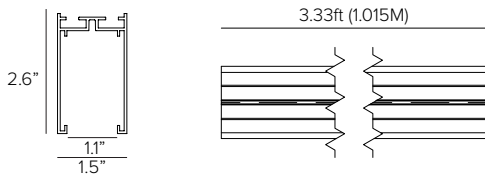

Field cuttable OZ SMALL surface/suspension aluminum profile for lead or standalone configurations.

Finish	<input type="radio"/>	<input checked="" type="radio"/>
Part No.	1T7050	1T7053

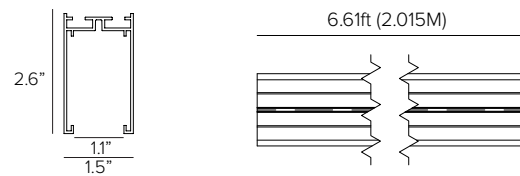

Field cuttable OZ SMALL surface/suspension aluminum profile for lead or standalone configurations.

Finish	<input type="radio"/>	<input checked="" type="radio"/>
Part No.	1T7051	1T7054

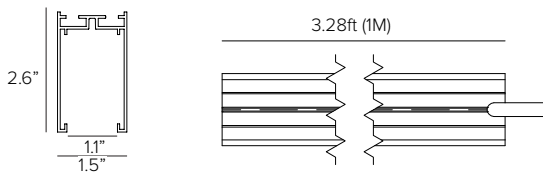

Field cuttable OZ SMALL surface/suspension aluminum profile for center and end configurations.

Finish	<input type="radio"/>	<input checked="" type="radio"/>
Part No.	1T7044	1T7047

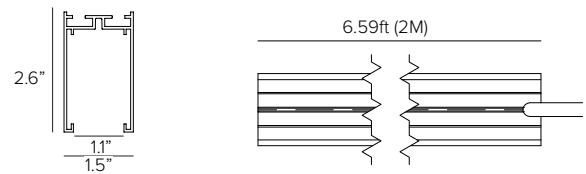

Field cuttable OZ SMALL surface/suspension aluminum profile for center and end configurations.

Finish	<input type="radio"/>	<input checked="" type="radio"/>
Part No.	1T7045	1T7048

2 - END CAP (REQUIRED)



OZ SMALL surface/suspension end cap kit (2pcs) for 1"W.

Finish	<input type="radio"/>	<input checked="" type="radio"/>
Part No.	1T7062	1T7063

OZ 48V SMALL SURFACE/SUSPENSION PROFILE

3 - MOUNTING SYSTEM (REQUIRED)

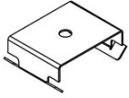

OZ surface profile installation clip, 1pc. Suggested 2pcs for 3ft (1M) L and 3pcs for 6.5ft (2M) L profiles.

Part No. **1T7065**

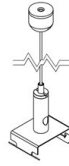

OZ suspension profile installation kit, includes 20ft L aircraft cable, 1pc. Suggested 2pcs for 3ft (1M) L and 3pcs for 6.5ft (2M) L profiles.

Part No. **1US7066**

4 - JOINT CONNECTORS (OPTIONAL)

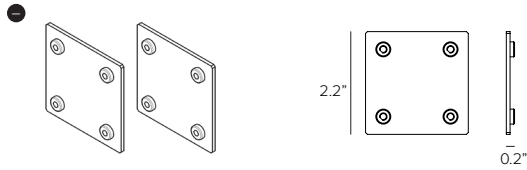

OZ surface/suspension profile linear joint connector kit, includes of 2pcs mechanical linear joints and 8pcs screws. Compatible with small and large suspended profiles.

Finish

Part No. **1T7064** **1T7097**

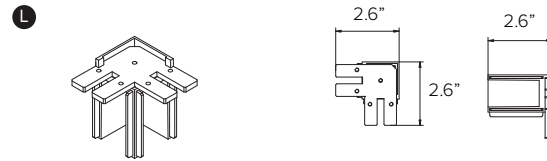

OZ SMALL surface/suspension profile L-joint connector.

Finish

Part No. **1T7056** **1T7059**

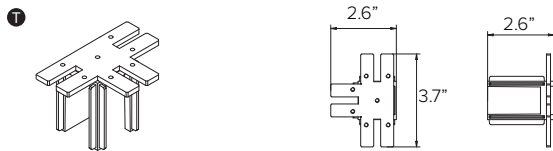

OZ SMALL surface/suspension profile T-joint connector.

Finish

Part No. **1T7057** **1T7060**

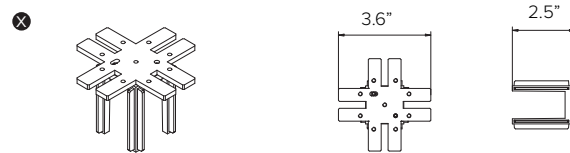

OZ SMALL surface/suspension profile X-joint connector.

Finish

Part No. **1T7058** **1T7061**

5 - COVER (OPTIONAL)

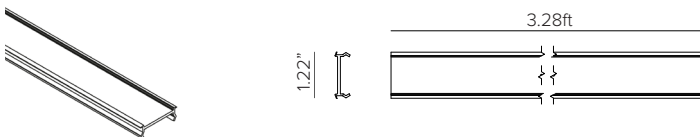

Field cuttable OZ SMALL surface/suspension cover.

Finish

Part No. **1T9595** **1T9597**

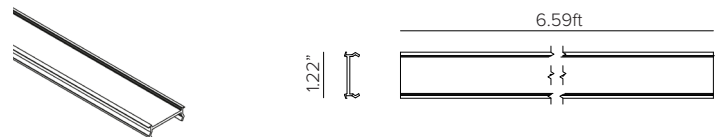

Field cuttable OZ SMALL surface/suspension cover.

Finish

Part No. **1T9596** **1T9598**

Plaster White Finish Deep Black Finish

OZ 48V SMALL SURFACE/SUSPENSION PROFILE

INSTALLATION DIAGRAMS

NOTE: Max of 4 connectors (excluding power feed) or 30ft or power rail per individual power supply.

CEILING OR SUSPENSION INSTALLATION

OZ Power Rail + OZ Surface / Suspended Profile

