



a brand of TARGETTI

DURATAPE™ HIGH DENSITY INDOOR IP20

KEY FEATURES

- Energy efficient high output narrow spaced LED's for uniform, uninterrupted emission with superior performance for continuous constant color in linear applications.
- Ideal for IP20 applications with reflective surfaces / direct view with use of profile and diffusion lens or OEM panel illumination.
- Sold per foot and manufactured to specified lengths with factory attached end preps.
- Features double sided substrate for optimum heat dissipation, minimizing voltage drop while increasing run lengths per power feed, standardizing electrical flow over entire length of the strip for maximum product reliability.
- Features double sided solder points for maximum conductivity and durability.
- Pre-assembled to specific lengths with various connector options for project requirements and efficient power configuration.
- Max continuous length: up to 10' per run (7.3W/ft)
- Multiple dimming options available.

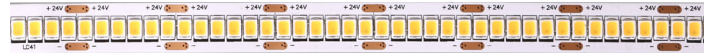

DETAILS

Spacing	0.13" OC LED Spacing
LEDs	91 LEDs per foot
Wattage	7.3W/ft
Color Temp	2200°K / 2700°K / 3000°K / 3500°K / 4000°K
Color Consistency	Bin centered on the Planck curve with a 2 step MacAdam tolerance.
CRI	Ra+95
End Preps	Factory prepped end preps available (See Page 2)
Mounting	Includes installation-ready 3M tape adhesive for simplified installation directly to mounting channel or application surface
Installation	Optional mounting channels and clips, protective lens covers, thermal channels for optimal maintainance. Field trimmable every 0.79"
Power Supply	Listed Class 2 output, 24V DC power supply required
Certifications	cULus Class 2 Listed Tested in accordance with LM-79-08 Energy efficient for California installations.
Compliance	ROHS compliant
Warranty	5 year warranty

DIMENSIONAL DRAWINGS

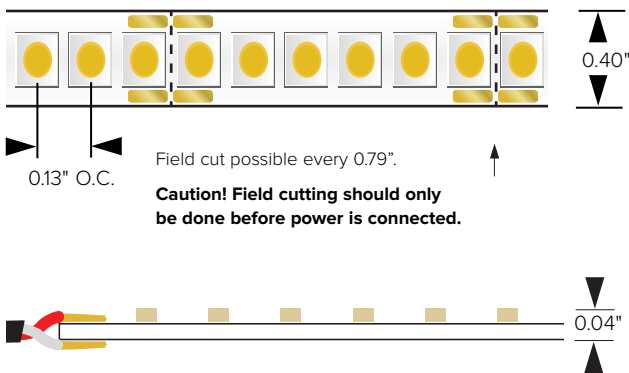

Duratape features double-sided solder points for maximum continuity for long lifespan.

FIXTURE DATA

Model	Efficacy* Lm/Wt	Lm/Ft	Wt/Ft
3000°K	811	592	7.3

* Meets Title 24 High efficacy rating.

LED DATA

Model	Wt/LED	Viewing Angle	Lifespan at 90% drive
ES 7.3W/ft	0.08W	120°	37,000hrs

* LEDs operating at 90% of LED manufacturers maximum current rating.

DESIGN INSTALLATION EXAMPLES



PRODUCT CODE	TYPE	WATTAGE	IP RATING	COLOR TEMP	VOLTAGE	+	END PREP	+	MOUNTING	+	POWER SUPPLY
DL — Duratape™	HD — High Density	73 — 7.3W/ft	I — Indoor IP20	22 — 2200°K 27 — 2700°K 30 — 3000°K 35 — 3500°K 40 — 4000°K	24 — 24VDC						

END PREPS AND CONNECTORS (REQUIRED) - Choose 1

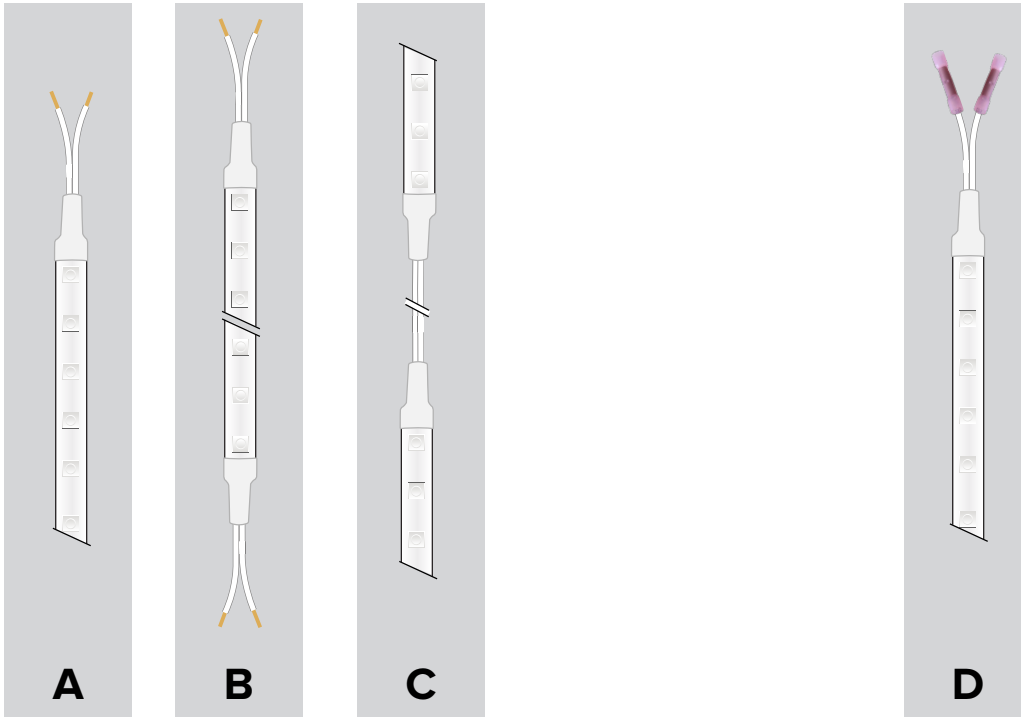

REQUIRED END PREPS:
(One required for each run of tape)

A

07U11CBL1: END PREP

Factory attached single lead wire prep. 24" Lead wire/dead end allows for connection to power at lead end and field trim of Duratape product at the other end.

07U11ADDCBL-XX: ADDITIONAL LEAD WIRE

Additional lead wire purchased per foot and factory attached to specified run leads. Lead wire can be field cut to desired length.

B

07U11CBL2: END PREP

Factory attached double ended lead wire prep. 24" lead wire at both ends. One end can be used for power connectivity while the other end can be used for interconnection to run to an additional length of Duratape. **Caution: Pay attention to max run lengths and voltage drops from total lead/fold wire lengths.**

07U11ADDCBL-XX: ADDITIONAL LEAD WIRE

Additional lead wire purchased per foot and factory attached to specified run leads. Lead wire can be field cut to desired length.

C

07U11FOLD CBL-XX

Wire fold (specified length). Wire folds are factory attached to Duratape to meet your specified installation requirements. Wire fold lengths available are 1", 2", 3", 4", 6", 12". Add length number to end of part number. **Caution: Pay attention to max run lengths and voltage drops from total lead/fold wire lengths.**

OPTIONAL CONNECTORS:

D

07U11ADDCON

Additional connectors. Lead wire connectors 2/ea per connection.

PROFILE OPACITY LEVEL KEY:



Uniform
Direct View



Blended
Direct / Indirect View



Pixelated
Indirect View

CLIPS AND SURFACE PROFILES



DL-CLP-20

DuraTape ES plastic mounting clip, package of 10 each. Recommended quantities per use: Straight flat run aiming upward 12" O.C. (1/ft); Curved aiming upward or wall mounted straight 6" O.C. (2/ft); Wall mounted curved or ceiling mounted 3" O.C. (4/ft).

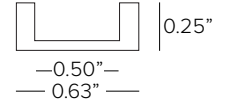
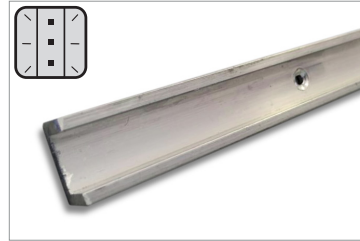

DL-ALUM-U-8

Low profile aluminum U-Profile for linear run lengths. Available in 8ft lengths.

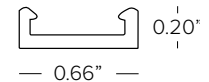
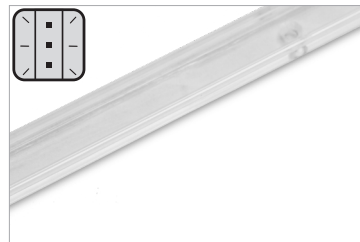

DL-MCHAN-8

Linear Mounting profile. Available in 8' lengths.



DL-W-2PC-C (Clear)

DL-W-2PC-F10/F30/F60 (Frosted)

Two-piece mounting tube; base (clear) with cover (frosted) for linear applications. Frosted diffusion levels, 10%, 30% or 60%. Available in 4' lengths.

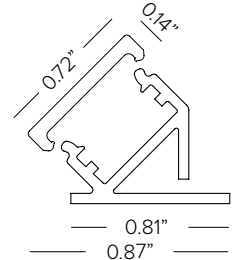
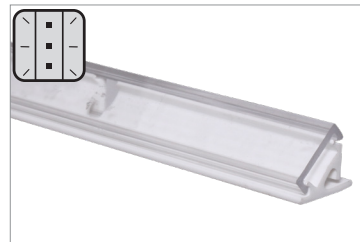
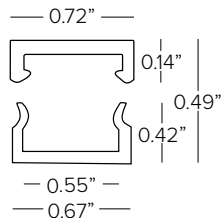

DL-W-45-MCH-4 (Base, REQUIRED)

45° mounting base (white) for 45° mounted linear applications. Available in 4' lengths.

DL-W-45-CVR-4-C (Clear)

DL-W-45-CVR-4-F10/F30/F60 (Frosted)

45° mounting base cover. Available in 4' lengths.

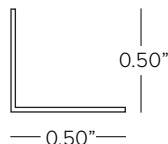

DL-ALUM-L-8

Aluminum L-Profile 1/2" x 1/2" for linear run lengths. DuraTape can be mounted at either 0° or 90° mounting positions. Available in 8ft lengths.

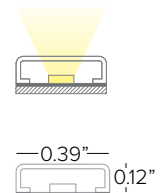

P01E-S-PF-100

Surface mount polycarbonate diffuser profile designed to protect strips from dirt and allow for perfect maintenance. Available in 3.28ft (1M) lengths.

SURFACE PROFILES



P01B-S-PF-300
Aluminum profile with white PMMA screen for surface or recessed installation with limited width. Equipped with angle-joint accessory. Available in 118in (3M) lengths.

NOTE: 118 inch lengths must be shipped via freight only. For efficient shipping via UPS/Fedex, lengths can be cut to 59 inch upon request.

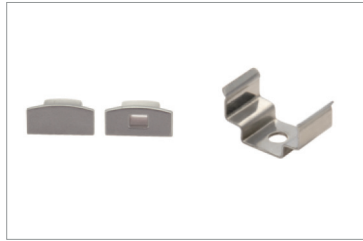

P01B-A-EC
3+3 pc silver end caps.
P01B-A-MC
4 Metal mounting clips.

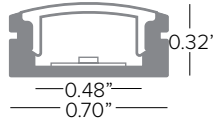

P01B-A-CP
3 pc silver color junction brackets.
P01B-A-CP90
3 pc silver color 90° junction brackets.

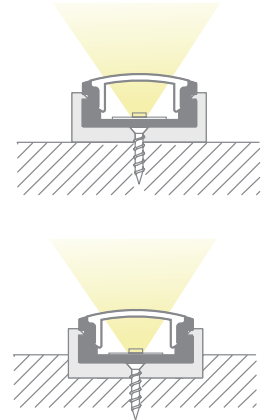

P02B-S-PF-300
Aluminum profile with white PMMA screen for surface or recessed installation with limited width. Equipped with angle-joint accessory. Available in 118in (3M) lengths.



P02B-A-EC
3+3 pc silver end caps.
P02B-A-MC
4 Metal mounting clips.

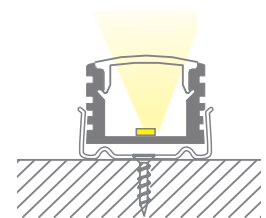
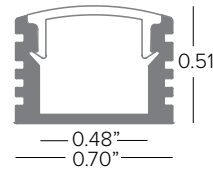

NOTE: 118 inch lengths must be shipped via freight only. For efficient shipping via UPS/Fedex, lengths can be cut to 59 inch upon request.



P03B-S-PF-300
Aluminum profile with polycarbonate lens with uniform light distribution for surface or recessed with suitable clips. Available in 118in (3M) lengths.



P03B-A-EC
3+3 pc silver end caps.
P03B-A-MC
3 Metal mounting clips.

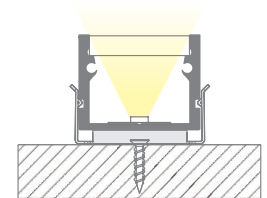
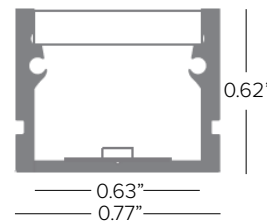

NOTE: 118 inch lengths must be shipped via freight only. For efficient shipping via UPS/Fedex, lengths can be cut to 59 inch upon request.

SURFACE PROFILES CONT.

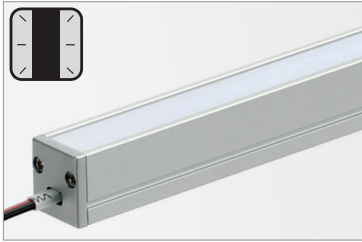

P04A-S-PF-200

Aluminum profile with polycarbonate screen for surface installation. Available in 79in (2M) lengths.

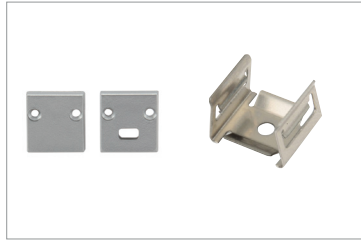

P04A-A-EC

2+2 pc silver end caps.

P04A-A-MC

4 Metal mounting clips.

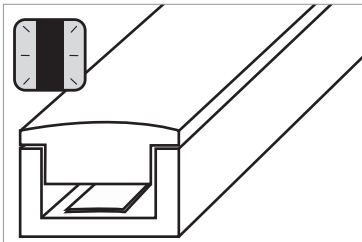
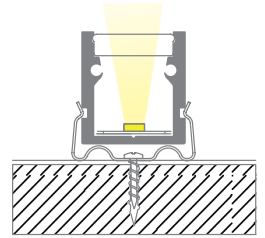
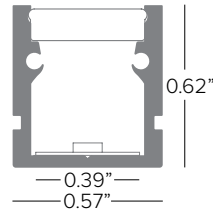

DL-ALUM-C-6

Surface mounted two-piece continuous illumination profile. 1/2"H x 5/8"W aluminum U-channel with 6" OC screw holes. Snap in full diffusion lens for shadowless light distribution. Available in 6ft lengths.

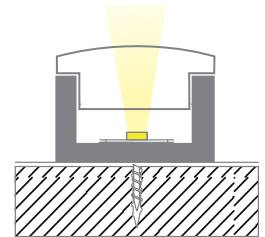
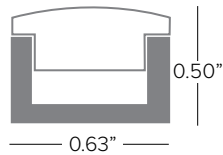

P04B-S-PF-300

Aluminum profile with polycarbonate screen for surface or recessed with suitable clips. Available in 118in (3M) lengths.

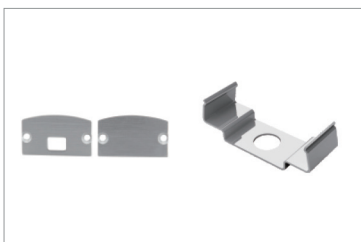

P04B-A-EC

3+3 pc metal end caps.

P04B-A-MC

3 Metal mounting clips.

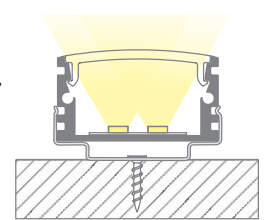
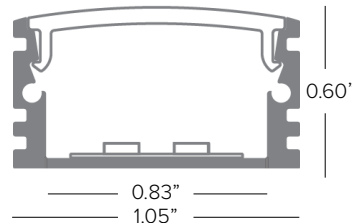

NOTE: 118 inch lengths must be shipped via freight only. For efficient shipping via UPS/Fedex, lengths can be cut to 59 inch upon request.

SURFACE PROFILES CONT.



P03F-S-PF-300

Aluminum profile for surface or recessed corner with suitable clips.
Available in 118in (3M) lengths.

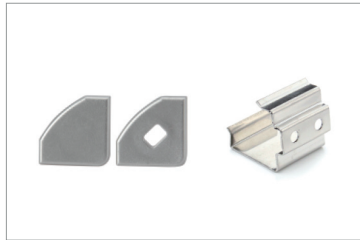

P03F-A-EC

3+3 pc end caps.

P03F-A-MC

3 Metal mounting clips.

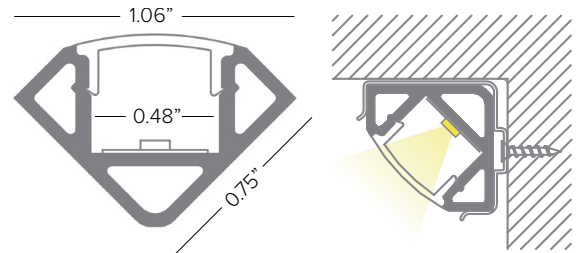

NOTE: 118 inch lengths must be shipped via freight only. For efficient shipping via UPS/Fedex, lengths can be cut to 59 inch upon request.



P04F-S-PF-300

Aluminum profile for surface in 90° angles with suitable clips.
Available in 118in (3M) lengths.

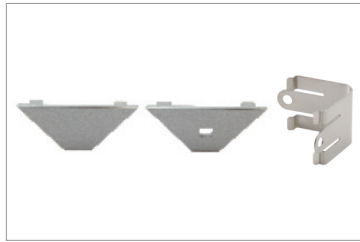

P04F-A-EC

3+3 pc end caps.

P04F-A-MC

3 Metal mounting clips.

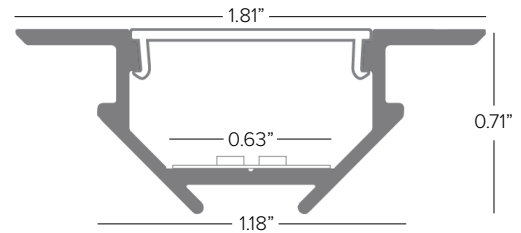

NOTE: 118 inch lengths must be shipped via freight only. For efficient shipping via UPS/Fedex, lengths can be cut to 59 inch upon request.

SURFACE PROFILES CONT.

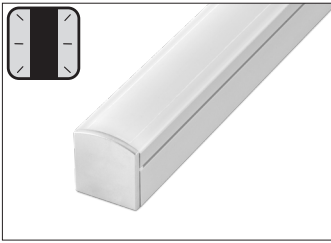

PRAP-U

Surface mount aluminum profile. Anodized aluminum rigid profile complete with opal translucent diffuser cover. Available in 79in (2M) lengths.

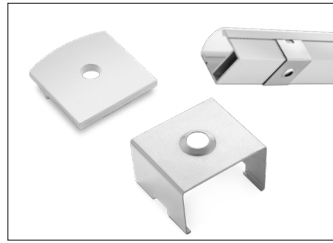

KTRAP-UEC

5 + 5 silver color end caps

KTRU-CL

5 sets of clips



OR-DEV

Set of steel supports required with use of KTORDEV-U.

KTORDEV-U

Set of aluminum mounting heads required with use of OR-DEV.

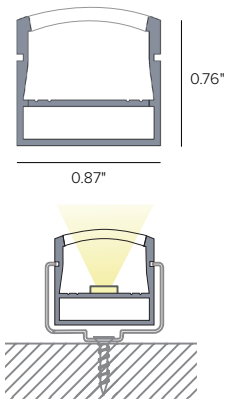

PRIN-U

Flush mount aluminum profile. Anodized aluminum rigid profile complete with opal translucent diffuser cover. Available in 79in (2M) lengths.

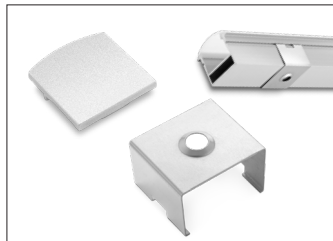

KTRPRIN-UEC

5 + 5 silver color end caps

KTRPRU-CL

5 sets of clips

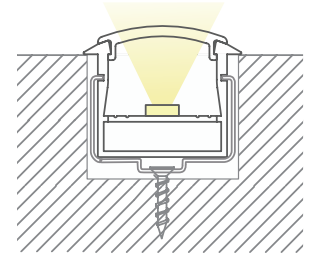
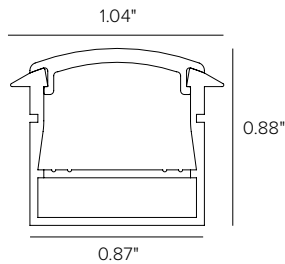

PRAN-U

45° aluminum profile. Anodized aluminum rigid profile complete with opal translucent diffuser cover. Available in 79in (2M) lengths.



KTRPRAN-UEC

5 + 5 silver color end caps

KTRPRAN-UCL

5 sets of clips

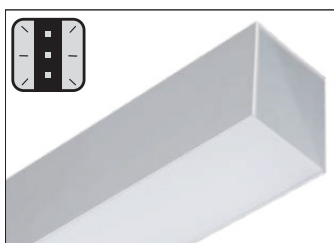
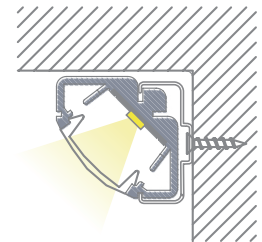
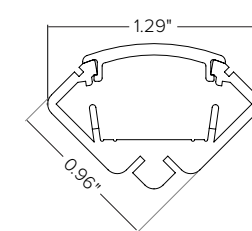

PRDES0

Aluminum profile for surface mount. Available in 4ft lengths.

PRDES0-SL

Rear support for surface mount.

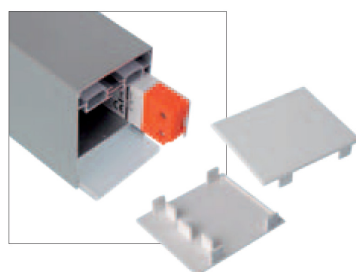

PRDES0-FL

Front screen in flat opal polycarbonate plate.

KTRDES0-FL

Set of two side end caps flat screen.

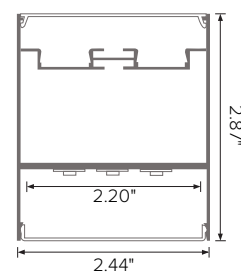

RECESSED PROFILES



P02H-S-PF-300
Aluminum profile with white PMMA screen for recessed installation with limited width. Available in 118in (3M) lengths.

NOTE: 118 inch lengths must be shipped via freight only. For efficient shipping via UPS/Fedex, lengths can be cut to 59 inch upon request.

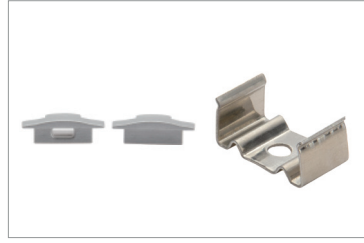

P02H-A-EC
3+3 pc silver end caps.
P02H-A-MC
3 Metal mounting clips.



P02H-A-CP
3 pc silver junction brackets.
P02H-A-CP90
3 junction brackets with 90° angle.

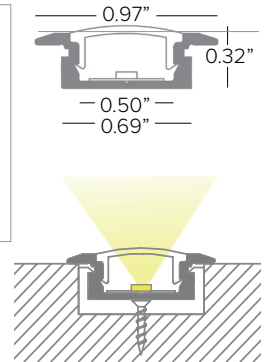

P03E-S-PF-300
Aluminum high impact walk over rated profile with white PMMA screen for recessed installation. Available in 118in (3M) lengths.



P03E-A-EC
3+3 pc end caps.

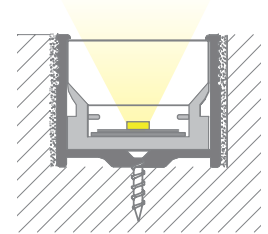
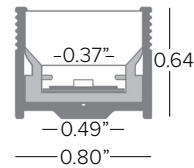

NOTE: 118 inch lengths must be shipped via freight only. For efficient shipping via UPS/Fedex, lengths can be cut to 59 inch upon request.



PRINTC-G
Rigid high impact resistant PMMA profile complete with a white plastic diffuser lensed channel for recessed walk over installation. Complete with track for easy strip insertion. Available in 3.28ft (1M) lengths.

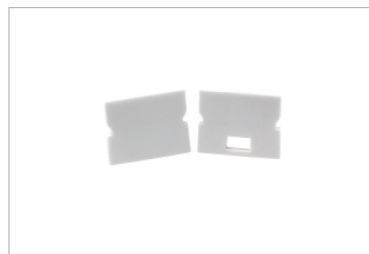

KTPRINTC-G
2+2 PC end caps

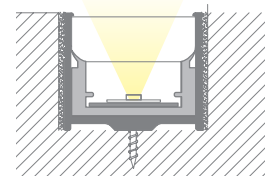
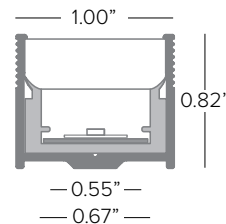

RECESSED PROFILES CONT



PRINTC-GUS

Rigid high impact resistant PMMA profile complete with two part white plastic diffuser lens and aluminum channel for surface or recessed mounting. Available in 3.28ft (1M) lengths.

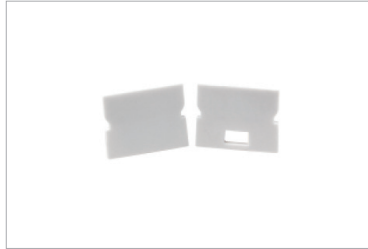

KTRPRINTC-G

2+2 PC end caps

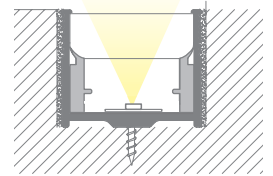
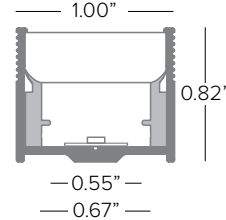

P03H-S-PF-300

Aluminum profile with white polycarbonate screen for recessed installation. Available in 118in (3M) lengths.

NOTE: 118 inch lengths must be shipped via freight only. For efficient shipping via UPS/Fedex, lengths can be cut to 59 inch upon request.

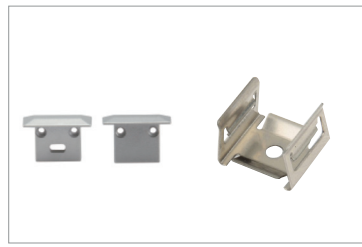

P03H-A-EC

3+3 pc silver end caps.

P03H-A-MC

3 Metal mounting clips.



P03H-A-FS

3 pc metal ceiling attachment springs.

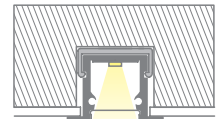
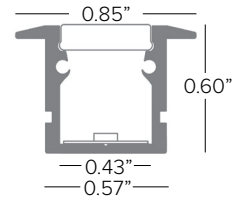
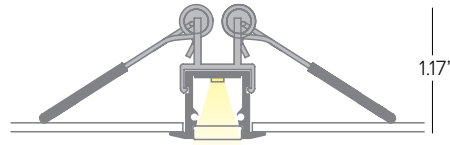

P04H-S-PF-300

Aluminum profile with white polycarbonate screen for recessed installation. Available in 118in (3M) lengths.

NOTE: 118 inch lengths must be shipped via freight only. For efficient shipping via UPS/Fedex, lengths can be cut to 59 inch upon request.



P04H-A-EC

3+3 pc silver end caps.

P04H-A-MC

3 Metal mounting clips.



P04H-A-FS

3 pc metal ceiling attachment springs.

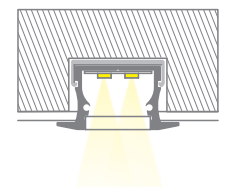
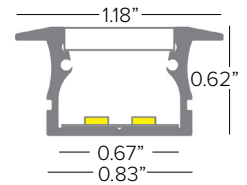
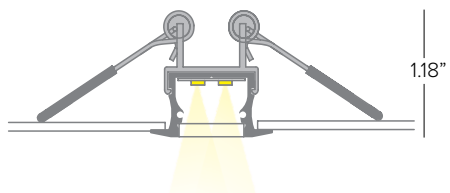

RECESSED PROFILES CONT



P08D-S-PF-300

Aluminum profile with white PMMA screen for recessed installation. Available in 118in (3M) lengths.

Max of (3) strips per profile.

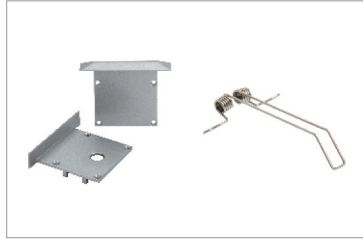

P08D-A-EC

3+3 pc silver end caps.

P08D-A-SP

3 pc metal ceiling attachment springs.

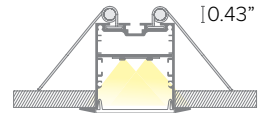
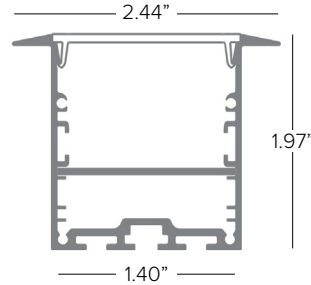

NOTE: 118 inch lengths must be shipped via freight only. For efficient shipping via UPS/Fedex, lengths can be cut to 59 inch upon request.

ADJUSTABLE PROFILES



P02C-S-PF-300

180° adjustable aluminum profile with wall washer function for surface with suitable clips. Available in 118in (3M) lengths.

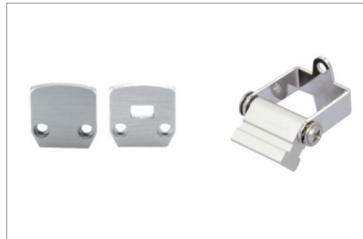

P02C-A-EC

3+3 metal end caps.

P02C-A-OB

3 Metal adjustable brackets.

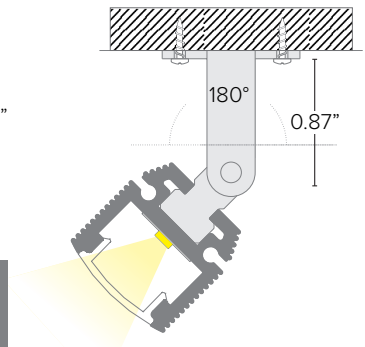
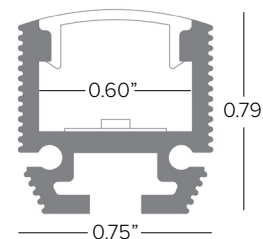

NOTE: 118 inch lengths must be shipped via freight only. For efficient shipping via UPS/Fedex, lengths can be cut to 59 inch upon request.



P03C-S-PF-300

180° adjustable aluminum profile with wall washer function for surface with suitable clips. Lens shape creates narrower spread. Available in 118in (3M) lengths.

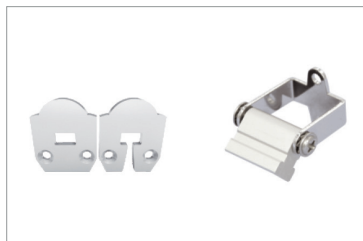

P03C-A-EC

3+3 metal end caps.

P03C-A-OB

6 Metal adjustable brackets.

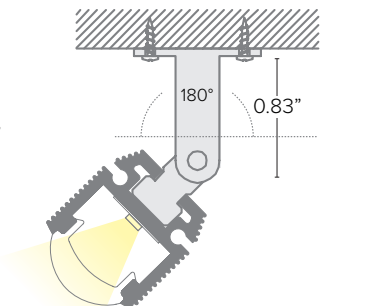
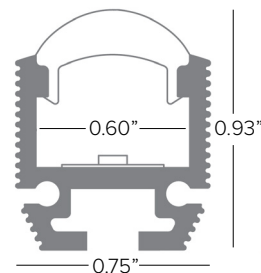

NOTE: 118 inch lengths must be shipped via freight only. For efficient shipping via UPS/Fedex, lengths can be cut to 59 inch upon request.

ADJUSTABLE PROFILES CONT.



P04C-S-PF-300
Fixed profile at 30° with a wall washer function for surface installation. Available in 118in (3M) lengths.



P04C-A-EC
3+3 metal end caps.

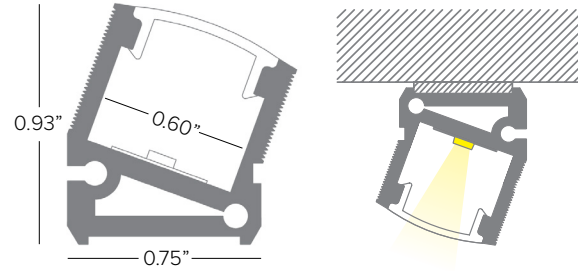

NOTE: 118 inch lengths must be shipped via freight only. For efficient shipping via UPS/Fedex, lengths can be cut to 59 inch upon request.

SUSPENDED PROFILES

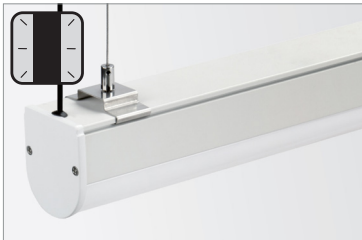

P07A-S-PF-300
Aluminum profile with white polycarbonate screen for surface or suspension installation. Available in 118in (3M) lengths.

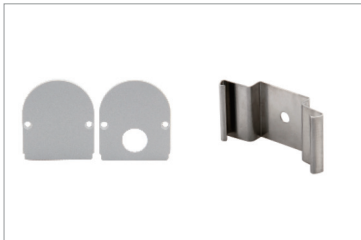

P07A-A-EC
3+3 pc white end caps.
P07A-A-MC
6 Metal mounting clips.
(One set recommended for every 4ft)



P07A-A-FS
3 pc metal suspension cables.

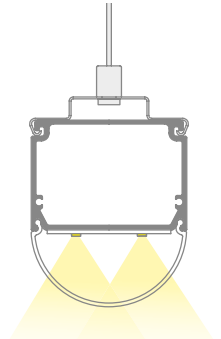

NOTE: 118 inch lengths must be shipped via freight only. For efficient shipping via UPS/Fedex, lengths can be cut to 59 inch upon request.

Max of (3) strips per profile.

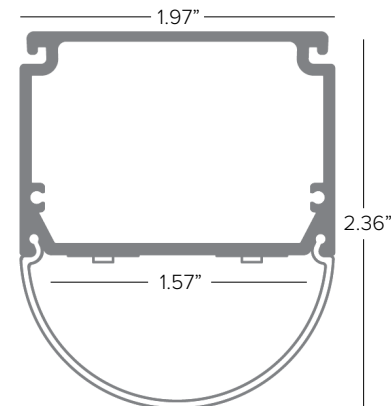

SUSPENDED PROFILES CONT.

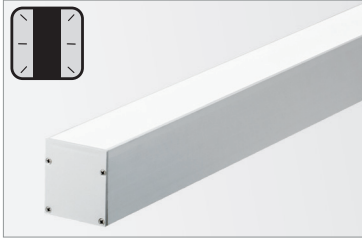

P01L-S-PF-300

Aluminum profile with white polycarbonate screen for suspension installation. Available in 118in (3M) lengths.

NOTE: 118 inch lengths must be shipped via freight only. For efficient shipping via UPS/Fedex, lengths can be cut to 59 inch upon request.

Max of (3) strips per profile.



P01L-A-EC

3+3 pc silver end caps.



P01L-A-FS

3 pc metal suspension cables.

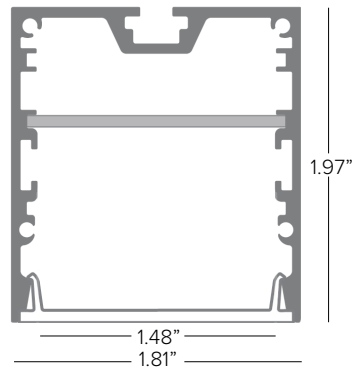
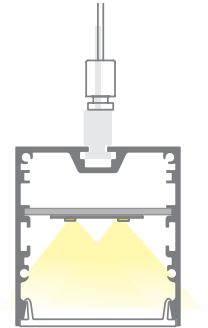

DECORATIVE PROFILES



P06A-S-PF-300

Aluminum profile with white PMMA screens for wall installation with wall washer effect upwards and downwards. Available in 118in (3M) lengths.

Max of (2) strips per profile direction.

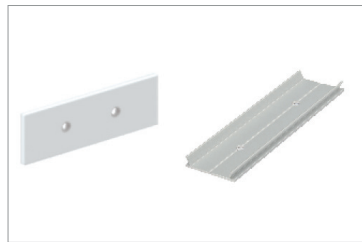

P06A-A-EC

3+3 pc silver end caps.

P06A-A-MC

1 set of metal brackets.

NOTE: 118 inch lengths must be shipped via freight only. For efficient shipping via UPS/Fedex, lengths can be cut to 59 inch upon request.

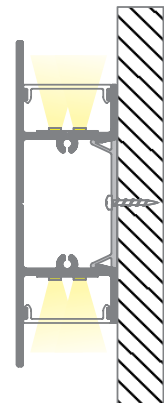
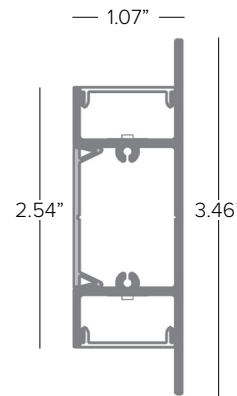

PLASTER RECESSED PROFILES



PRINC-G

Flush Mount aluminum profile for installation in plasterboard. Complete with white lens. Available in 79in (2M) lengths.

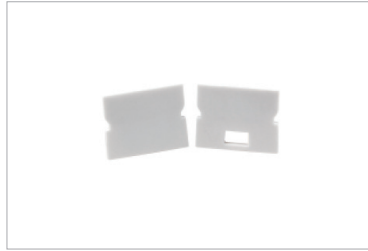

KTPRINC-G

2+2 PC end caps

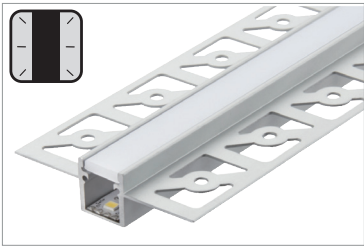
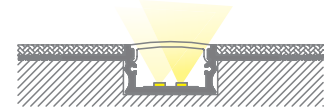
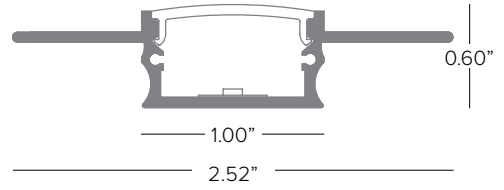

P05B-S-PF-300

Aluminum profile with white PMMA screen for trimmed plaster-in flush recessed installation. Available in 118in (3M) lengths.



P05B-A-EC

3+3 pc end caps.

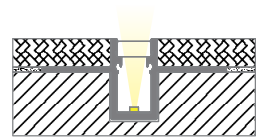
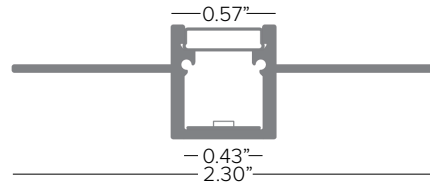

NOTE: 118 inch lengths must be shipped via freight only. For efficient shipping via UPS/Fedex, lengths can be cut to 59 inch upon request.



a brand of TARGETTI

DURATAPE™ HIGH DENSITY INDOOR IP20

Power Supply (REQUIRED)	Type	Wattage	Input/Output Voltage	Dimmable	IP Rating	Output	Dimensions
DMLE301242UD	EMCOD MLE ELECTRONIC UNIVERSAL DIMMING DRIVER WITH WIRING COMPARTMENT.	30W	120-277V / 24V	MLV / ELV / 0-10V / TRIAC	NEMA3R ENCLOSURE	UL CLASS 2	4.47" X 6.79" X 1.38"
DMLE601242UD	EMCOD MLE ELECTRONIC UNIVERSAL DIMMING DRIVER WITH WIRING COMPARTMENT.	60W	120-277V / 24V	MLV / ELV / 0-10V / TRIAC	NEMA3R ENCLOSURE	UL CLASS 2	4.47" X 6.79" X 1.38"
DMLE961242UD	EMCOD MLE ELECTRONIC UNIVERSAL DIMMING DRIVER WITH WIRING COMPARTMENT.	96W	120-277V / 24V	MLV / ELV / 0-10V / TRIAC	NEMA3R ENCLOSURE	UL CLASS 2	5.16" X 7.73" X 1.54"
DMLE1922242UD	EMCOD MLE ELECTRONIC UNIVERSAL DIMMING DRIVER WITH WIRING COMPARTMENT.	2X96W	120-277V / 24V	MLV / ELV / 0-10V / TRIAC	NEMA3R ENCLOSURE	UL CLASS 2	5.04" X 10.94" X 1.81"
DMLE2882242UD	EMCOD MLE ELECTRONIC UNIVERSAL DIMMING DRIVER WITH WIRING COMPARTMENT.	3X96W	120-277V / 24V	MLV / ELV / 0-10V / TRIAC	NEMA3R ENCLOSURE	UL CLASS 2	5.04" X 10.94" X 1.81"
DEL60PWM	MEANWELL ELECTRONIC STANDALONE PWM DRIVER, UL LISTED ENCLOSURE PROVIDED BY OTHERS.	60W	120-277V / 24V	0-10V <10%	IP67	UR CLASS 2	5.9" X 2.09" X 1.38"
DELI601241CPWM	MEANWELL ELECTRONIC PWM DRIVER.	60W	120-277V / 24V	0-10V <10%	NEMA1 ENCLOSURE	UL CLASS 2	10" x 10" x 4" ¹
DEL90PWM	MEANWELL ELECTRONIC STANDALONE PWM DRIVER, UL LISTED ENCLOSURE PROVIDED BY OTHERS.	90W	120-277V / 24V	0-10V <10%	IP67	UR CLASS 2	6.73" X 2.48" X 1.48"
DELI901241CPWM	MEANWELL ELECTRONIC PWM DRIVER.	90W	120-277V / 24V	0-10V <10%	NEMA1 ENCLOSURE	UL CLASS 2	10" x 10" x 4" ¹
DELI1802242CPWM	MEANWELL ELECTRONIC PWM DRIVER.	2X90W	120-277V / 24V	0-10V <10%	NEMA1 ENCLOSURE	UL CLASS 2	12" x 12" x 4" ¹
DELI2703243CPWM	MEANWELL ELECTRONIC PWM DRIVER.	3X90W	120-277V / 24V	0-10V <10%	NEMA1 ENCLOSURE	UL CLASS 2	12" x 12" x 4" ¹
DMLV40124D	MAGNETIC LOW VOLTAGE TRANSFORMER	40W	120V / 24V	MLV DIMMING < 1%	NEMA3R ENCLOSURE	UL CLASS 2	8.13" x 3.93" x 1.59" ¹
DMLV60124D	MAGNETIC LOW VOLTAGE TRANSFORMER	60W	120V / 24V	MLV DIMMING < 1%	NEMA3R ENCLOSURE	UL CLASS 2	8.13" x 3.93" x 1.59" ¹
DMLV96124D	MAGNETIC LOW VOLTAGE TRANSFORMER	96W	120V / 24V	MLV DIMMING < 1%	NEMA3R ENCLOSURE	UL CLASS 2	8.13" x 3.93" x 1.59" ¹
PS060	LUTRON HI-LUME PREMIER 0.1% CONSTANT VOLTAGE DRIVER WITH UL LISTED ENCLOSURE	96W	UNIVERSAL 120-277 VAC	HI-LUME ECOSYSTEM 0.1%	IP20/NOM CERTIFIED	UL CLASS 2	10.5" x 5.5" x 2" ¹

¹ Dimensions include enclosure with mounting bracket.

* Constant voltage drivers 50/60HZ, voltage regulated with short circuit protection. Operating temperature -40 C- 80° C

* Installation of power supply must be compliant to Class 2 installation standards. Refer to NEC and local building code requirements.

* Consult factory for additional driver options (ie: DMX, DALI, wattage, size, shape, Lutron, ELDO, or others).

MAXIMUM INTERCONNECTED TAPE LENGTH PER DRIVER

Fixture Wattage	Driver Wattage								
	40W	60W	96W	90W	2X90W	3X90W	100W	2X100	
7.3W/ft	4FT	6FT	10FT	9FT	(2) 9FT	(3) 9FT	10FT	(2) 10FT	

PHOTOMETRY

DURATAPE HD						POLAR GRAPH
Fixture Power	7.3W	7.3W	7.3W	7.3W	7.3W	
Fixture Output	381Lm	421Lm	592Lm	442Lm	622Lm	
Kelvin Temp	2200°K	2700°K	3000°K	3500°K	4000°K	
Beam Spread	120°	120°	120°	120°	120°	
IMax	316cd/klm	316cd/klm	316cd/klm	316cd/klm	316cd/klm	
Efficacy	52.2 Lm/W	57.7 Lm/W	81.1 Lm/W	61 Lm/W	85.2 Lm/W	