

# L225C-M

## INTERIOR

Spotlights | For ceilings, walls

● Dry location



Available with: Spot, Narrow Flood, and Flood beam angles.

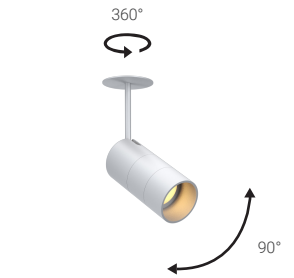

Shown with HLD accessory  
Available with: Super Spot, Spot, Narrow Flood, and Flood beam angles.

### Ordering Information

Clear Form

Date : \_\_\_\_\_

Quantity : \_\_\_\_\_

Project : \_\_\_\_\_

Note : \_\_\_\_\_

Type : \_\_\_\_\_

### Specifications

Luminaire | Example Code: L225-C3-M-8-W30H-N- [ ]-2-MA

Product	Canopy <sup>1</sup>	Size	Version	CCT & CRI	Beam Angle	Accessories-Holder <sup>2</sup> (optional)	Accessories-Louver <sup>3</sup> (optional)	Stem Length <sup>4</sup>	Finish <sup>5</sup>					
<b>L225</b>	<b>M</b>													
C1	M medium	4 4W	W27H 2700K 90+	SS super spot 7°	HLD louver holder	ELB4 eggcrate louver, black anodized	2 2" (51mm)	Aluminum Finishes:						
C3									8 8W	W30H 3000K 90+	S spot 20°	X custom length	MA matte clear anodized	
C4											N narrow flood 30°			WH white powder coat
C21											F flood 48°			
C23														

### System Components (Ordered Separately)

Remote Driver : \_\_\_\_\_

\* Consult MP Lighting Website or Factory.

### Important Notes

#### Specification

- See pg.3 - for different canopy options and its dimensions.
- HLD is required for louvers, Super Spot beam angle, and other accessories supplied on site.
- ELB4 accessory not available with Super Spot beam angle option.
- 1" (25mm) increments to maximum of 8" (2438mm). Minimum 4" (102mm) stem for C23 canopy.
- Refer to Appendix or MP Lighting website for complete look of luminaire with different finish options. Please consult factory for custom finish for shrouds. WH not available with Super Spot beam angle.

#### Warranty Notes & Disclaimer

Malfunction and damage to product due to incompatible dimming system or misuse will not be covered under warranty. Consult MP Lighting for recommended drivers. If the fixture has an option to be installed with a dimming control system, consult a dimming system manufacturer with minimum load before installing. MP Lighting reserves the right, at its sole discretion, at any time and without notice, to make design changes to any of our products. Consult MP Lighting website for most updated documentation.

# L225C-M

## INTERIOR

Spotlights | For ceilings, wall

● Dry location



Available with: Spot, Narrow Flood, and Flood beam angles.

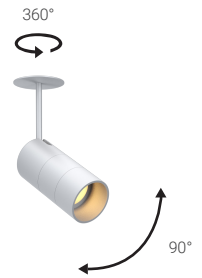

Shown with HLD accessory  
Available with: Super Spot, Spot, Narrow Flood, and Flood beam angles.

### Performance

Wattage	Forward Current	Power Consumption Budget per fixture (including driver)	LED output (Source)	Fixture Output (Delivered)
4W	350mA	4W	440 lm	208-261 lm
8W	700mA	8W	880 lm	371-433 lm

### Application

Environment	Dry Location approved. IP 20.
Mounting	Mounts to a 4" octagonal box using the mounting canopy.

### Electrical

Power Supplies	Remote LED drivers (120-277V AC input, <b>constant current output</b> ): Fixtures to be wired in series.
Control	<b>On/off control</b> <b>Dimming:</b> ELV or 0-10V dimming with appropriate drivers <b>Other options (consult factory):</b> TRIAC/MLV, DMX, DALI, Casambi, Power over Ethernet

### Luminaire Construction

LED Light Source	<b>Colour Consistency:</b> 2-step MacAdam: 2700K, 3000K, 90+ CRI
Weight	N/A
Material	<b>Fixture:</b> machined marine-grade aluminum
Supplied with	<b>Standard installation housing:</b> Comes with a canopy, a universal crossbar, two hex socket head screws, two wire-nuts, and an allen key.
Warranty & LED Life	5 years limited warranty Estimated useful life of LED is 50,000 hours.

### Ordered Separately

System Components	<b>Power supplies:</b> remote driver Please consult factory or visit <a href="#">Recommended Drivers</a> for available driver options.
-------------------	---

Mounting Options & Dimensions

LED Fixture Dimensions (shown with C21 canopy)

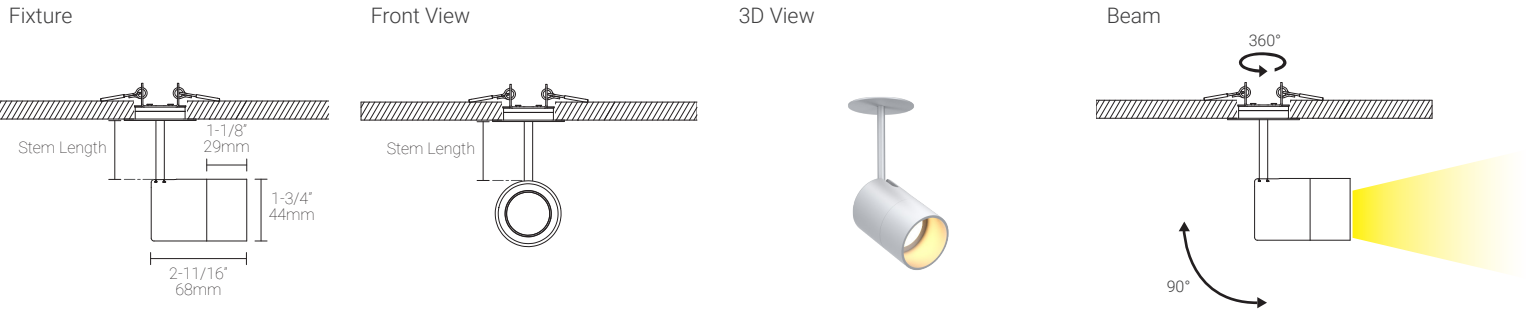

LED Fixture Dimensions (shown with HLD & C21 canopy)

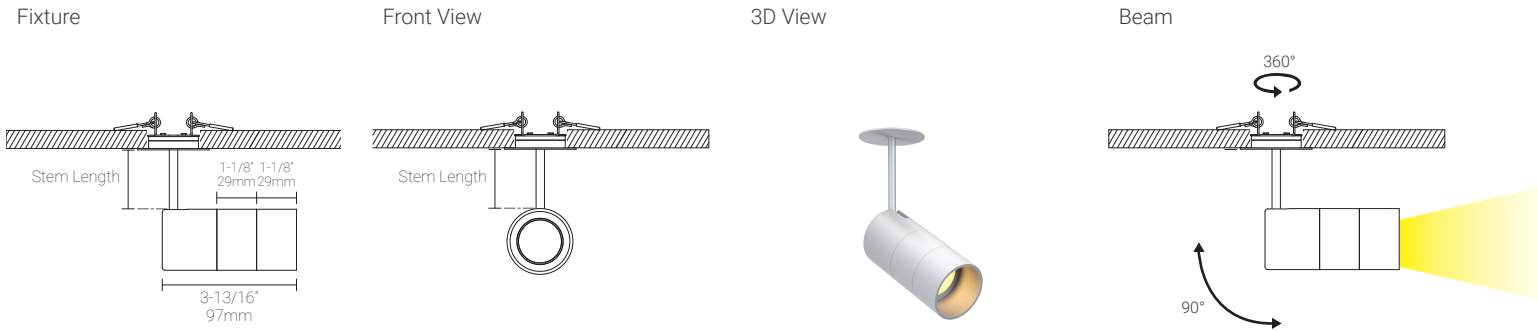

\* See Appendix for exploded view.

Measurement of Custom Stem Length (X)

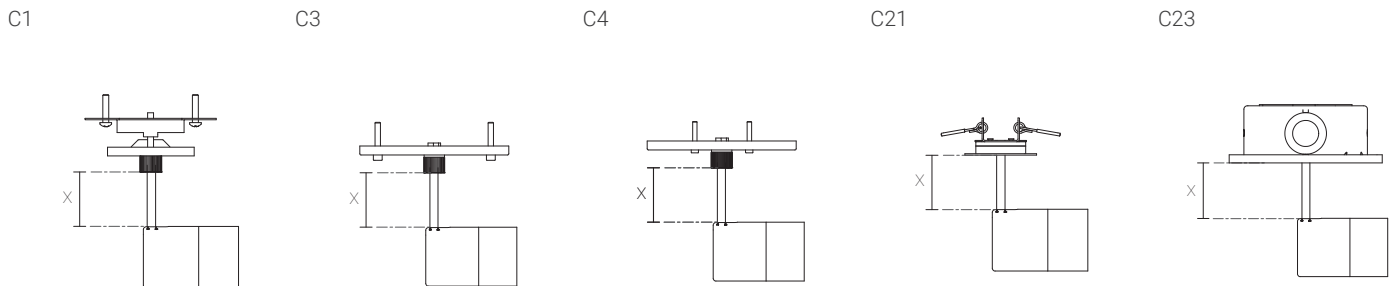

\* Spotlight can rotate 360° with C21 canopy.

\* Spotlight can rotate 360° with C23 canopy.

Mounting Options & Dimensions

C1

Canopy



Fixture with Canopy



Dimensions

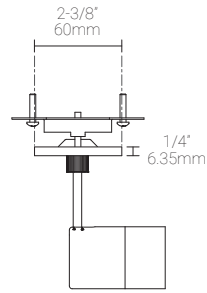

C3

Canopy



Fixture with Canopy



Dimensions

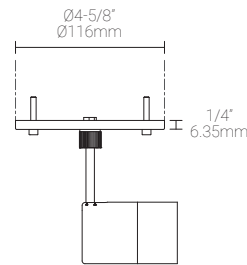

C4

Canopy

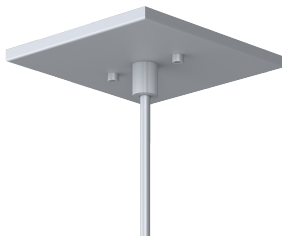

Fixture with Canopy

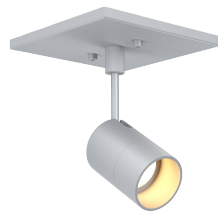

Dimensions

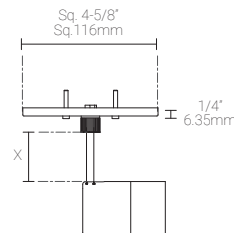

Mounting Options & Dimensions

C21

Canopy



Fixture with Canopy



Dimensions

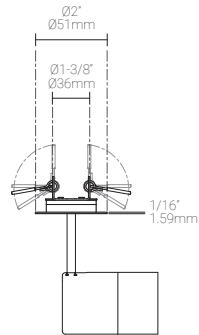

\* Spotlight can rotate 360° with C21 canopy.

C23

Canopy



Fixture with Canopy



Dimensions

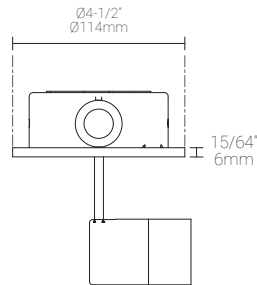

\* Spotlight can rotate 360° with C23 canopy.

Polar Candela Distribution

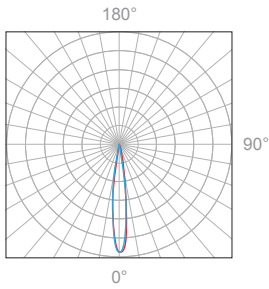

Beam Width: 20°



Illuminance at a Distance

Distance		Center Beam fc	Beam Width			
3.0ft	0.91m	180.3fc	1.0ft	0.30m	1.0ft	0.30m
6.0ft	1.83m	30.9fc	2.1ft	0.64m	2.1ft	0.64m
9.0ft	2.74m	19.2fc	3.1ft	0.94m	3.1ft	0.94m
12.0ft	3.66m	10.7fc	4.1ft	1.25m	4.1ft	1.25m
15.0ft	4.57m	7.3fc	5.2ft	1.58m	5.2ft	1.58m
18.0ft	5.49m	5fc	6.2ft	1.89m	6.2ft	1.89m

Delivered Lumen: 261 lm  
 ■ Vertical Beam Spread: 19.5°  
 ■ Horizontal Beam Spread: 19.5°

Polar Candela Distribution

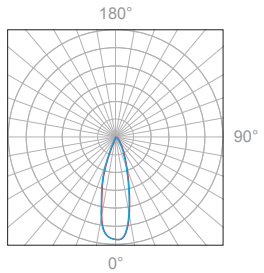

Beam Width: 30°

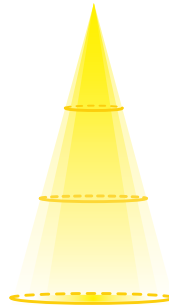

Illuminance at a Distance

Distance		Center Beam fc	Beam Width			
3.0ft	0.91m	114.2fc	1.4ft	0.43m	1.4ft	0.43m
6.0ft	1.83m	28.8fc	2.9ft	0.88m	2.9ft	0.88m
9.0ft	2.74m	12.8fc	4.3ft	1.31m	4.3ft	1.31m
12.0ft	3.66m	7.5fc	5.7ft	1.74m	5.7ft	1.74m
15.0ft	4.57m	4.8fc	7.2ft	2.19m	7.2ft	2.19m
18.0ft	5.49m	3.4fc	8.6ft	2.62m	8.6ft	2.62m

Delivered Lumen: 251 lm  
 ■ Vertical Beam Spread: 26.9°  
 ■ Horizontal Beam Spread: 26.9°

Polar Candela Distribution

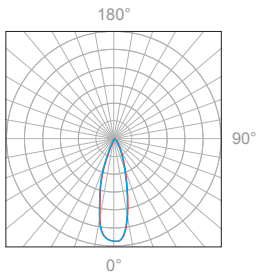

Beam Width: 48°

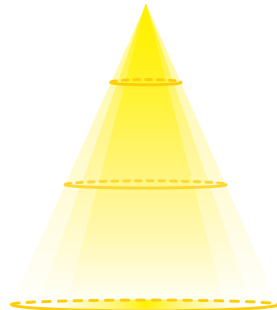

Illuminance at a Distance

Distance		Center Beam fc	Beam Width			
3.0ft	0.91m	45.9fc	2.6ft	0.79m	2.6ft	0.79m
6.0ft	1.83m	11.7fc	5.3ft	1.62m	5.3ft	1.62m
9.0ft	2.74m	5.2fc	7.9ft	2.41m	7.9ft	2.41m
12.0ft	3.66m	3fc	10.6ft	3.23m	10.6ft	3.23m
15.0ft	4.57m	2fc	13.2ft	4.02m	13.2ft	4.02m
18.0ft	5.49m	1.6fc	15.9ft	4.85m	15.9ft	4.85m

Delivered Lumen: 224 lm  
 ■ Vertical Beam Spread: 47.6°  
 ■ Horizontal Beam Spread: 47.6°

Polar Candela Distribution

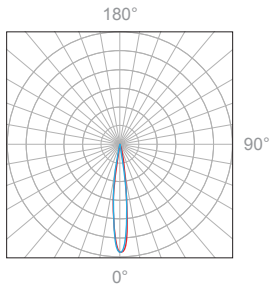

Beam Width: 20°



Illuminance at a Distance

Distance		Center Beam fc	Beam Width			
3.0ft	0.91m	328.6fc	1.0ft	0.30m	1.0ft	0.30m
6.0ft	1.83m	79fc	2.1ft	0.64m	2.1ft	0.64m
9.0ft	2.74m	35.2fc	3.1ft	0.94m	3.1ft	0.94m
12.0ft	3.66m	19.2fc	4.1ft	1.25m	4.1ft	1.25m
15.0ft	4.57m	12.8fc	5.2ft	1.58m	5.2ft	1.58m
18.0ft	5.49m	9.1fc	6.2ft	1.89m	6.2ft	1.89m

Delivered Lumen: 433 lm  
 ■ Vertical Beam Spread: 19.5°  
 ■ Horizontal Beam Spread: 19.5°

Polar Candela Distribution

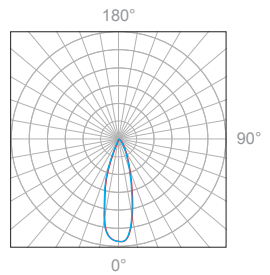

Beam Width: 30°

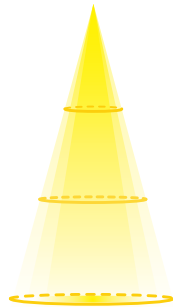

Illuminance at a Distance

Distance		Center Beam fc	Beam Width			
3.0ft	0.91m	202.7fc	1.4ft	0.43m	1.4ft	0.43m
6.0ft	1.83m	50.1fc	2.9ft	0.88m	2.9ft	0.88m
9.0ft	2.74m	21.3fc	4.3ft	1.31m	4.3ft	1.31m
12.0ft	3.66m	11.7fc	5.7ft	1.74m	5.7ft	1.74m
15.0ft	4.57m	8.2fc	7.2ft	2.19m	7.2ft	2.19m
18.0ft	5.49m	6.3fc	8.6ft	2.62m	8.6ft	2.62m

Delivered Lumen: 418 lm  
 ■ Vertical Beam Spread: 26.9°  
 ■ Horizontal Beam Spread: 26.9°

Polar Candela Distribution

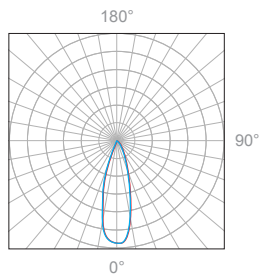

Beam Width: 48°

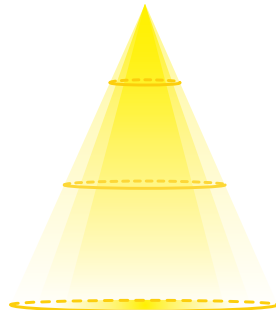

Illuminance at a Distance

Distance		Center Beam fc	Beam Width			
3.0ft	0.91m	75.7fc	2.6ft	0.79m	2.6ft	0.79m
6.0ft	1.83m	19.2fc	5.3ft	1.62m	5.3ft	1.62m
9.0ft	2.74m	8.5fc	7.9ft	2.41m	7.9ft	2.41m
12.0ft	3.66m	4.9fc	10.6ft	3.23m	10.6ft	3.23m
15.0ft	4.57m	3.3fc	13.2ft	4.02m	13.2ft	4.02m
18.0ft	5.49m	2.3fc	15.9ft	4.85m	15.9ft	4.85m

Delivered Lumen: 372 lm  
 ■ Vertical Beam Spread: 47.6°  
 ■ Horizontal Beam Spread: 47.6°

Appendix

Aluminum Finishes



MA matte clear anodized



BA black anodized



WH white powder coat

Aluminum Finishes with HLD



MA matte clear anodized



BA black anodized

Accessories



MA matte clear anodized



BA black anodized