

L303

INTERIOR

Trimless In-grade | For wall applications

● Dry location



Installed

Ordering Information

Clear Form

Date :	_____	Quantity :	_____
Project :	_____	Note :	_____
Type :	_____		_____

Specifications

Luminaire | Example Code: L303-2-W30H-N-C-[]-0-S6

Product	Version	CCT & CRI	Beam Angle ¹	Lens	Accessories ² (optional)	Internal Angle Bracket ³	Trim Finish ⁴
L303							
	1 1W 2 2W	W22S 2200K 80+ W30H 3000K 90+ W27H 2700K 90+ W35H 3500K 90+ W41H 4100K 90+	E elliptical 7°+36° SS super spot 8° S spot 12° N narrow flood 30° F flood 45° W wide flood 120°	C clear F frosted	LM louver, matte anodized LB louver, black anodized HM hex louver, matte anodized HB hex louver, black anodized AB angled louver, black anodized SB straight louver, black anodized QB square louver, black anodized RB ring louver, black anodized	0 no angle 20 20° angle X custom	Aluminum Finishes: MA matte clear anodized BA black anodized Stainless Steel Finish: S6 stainless steel 316

System Components (Ordered Separately)

Remote Driver : _____

* Consult MP Lighting Website or Factory.

Important Notes

Specification

- See Light Distribution section for illustration of different combinations of beam angles and angle bracket. Elliptical and Super Spot beam angles are only available with clear lens, and are not available with louver accessories or angle brackets.
- Louvers will be below the lens. Only available when there is no Internal Angle Bracket.
- Internal angle bracket is factory set, and cannot be field adjusted. 5° increments to maximum of 20° without accessories.
- Different finish options are only applicable to trim ring and not for LED module housing. Refer to Appendix or MP Lighting website for complete look of luminaire with different trim finish options.

Warranty Notes & Disclaimer

Malfunction and damage to product due to incompatible dimming system or misuse will not be covered under warranty. Consult MP Lighting for recommended drivers. If the fixture has an option to be installed with a dimming control system, consult a dimming system manufacturer with minimum load before installing. MP Lighting reserves the right, at its sole discretion, at any time and without notice, to make design changes to any of our products. Consult MP Lighting website for most updated documentation.

L303

INTERIOR

Trimless In-grade | For wall applications

- Dry location



Installed

Performance

Wattage	Forward Current	Power Consumption Budget per fixture (including driver)	LED output (Source)	Fixture Output (Delivered)
1W	350mA	1.3W	110 lm	27-63 lm
2W	700mA	2.6W	220 lm	49-119 lm

Application

Environment	Dry Location approved. IP 40.
Mounting	Comes with a machined flange that mounts to pre-installed standard 4" (102mm) octagonal box, 1-1/2"(38mm) deep minimum and 1/4"(6mm) setback from face of surface material. Can be wall or ceiling mounted.

Electrical

Electrical	Compatible with remote constant current DC driver, wiring in series.
Control	On/off control or phase dimming or 0-10V dimming with appropriate remote dimmable driver.

Luminaire Construction

LED Light Source	W22S = CCT: 2200K, CRI (Ra): 80+, Colour Consistency: 3SDCM W27H = CCT: 2700K, CRI (Ra): 90+, Colour Consistency: 2SDCM W30H = CCT: 3000K, CRI (Ra): 90+, Colour Consistency: 2SDCM W35H = CCT: 3500K, CRI (Ra): 90+, Colour Consistency: 2SDCM W41H = CCT: 4100K, CRI (Ra): 90+, Colour Consistency: 3SDCM
Weight	1.8 lbs (0.816 kg). Typical Aluminum Insert & Back Box only.
Material	Fixture: machined marine-grade aluminum or machined stainless steel (316) with tempered glass
Supplied with	Standard installation housing: Comes with a machined mounting flange
Warranty & LED Life	5 years limited warranty Estimated useful life of LED is 50,000 hours.

Ordered Separately

System Components	Power supplies: remote driver
-------------------	--------------------------------------

Mounting Options & Dimensions

LED Insert Dimensions

Fixture

Top View

3D View

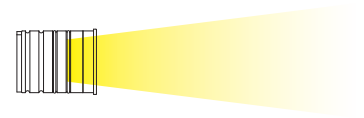
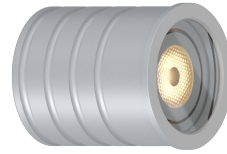
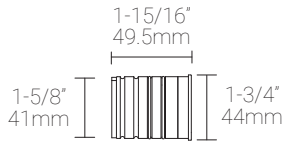

Drywall Installation (shown with a mounting flange)

Fixture with a mounting flange

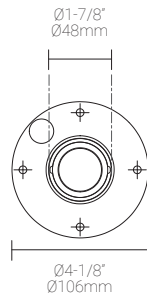
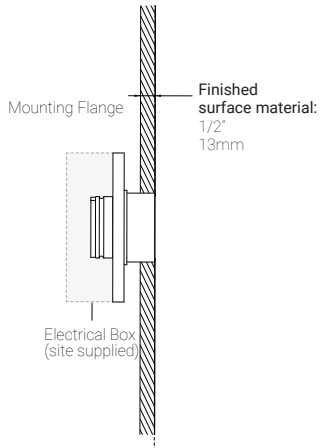

1W, 3000K, 90+ CRI

Polar Candela Distribution

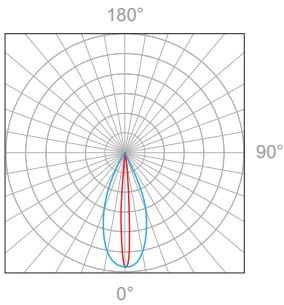

Beam Width: 7° + 36°

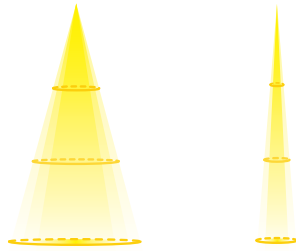

Illuminance at a Distance

Distance		Center Beam fc	Beam Width			
1.5ft	0.46m	92.9fc	1.0ft	0.30m	0.2ft	0.06m
3.0ft	0.91m	23.2fc	2.0ft	0.61m	0.4ft	0.12m
4.5ft	1.37m	10.3fc	2.9ft	0.88m	0.5ft	0.15m
6.0ft	1.83m	5.81fc	3.9ft	1.18m	0.7ft	0.21m
7.5ft	2.29m	3.72fc	4.9ft	1.49m	0.9ft	0.27m
9.0ft	2.74m	2.58fc	5.9ft	1.79m	1.0ft	0.30m

Delivered Lumen: 27 lm
 ■ Vertical Beam Spread: 36.1°
 ■ Horizontal Beam Spread: 6.7°

Polar Candela Distribution

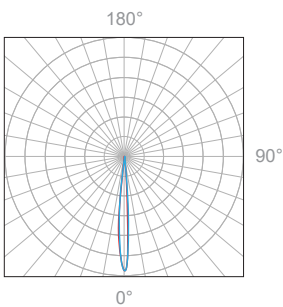

Beam Width: 8°



Illuminance at a Distance

Distance		Center Beam fc	Beam Width			
1.5ft	0.46m	537fc	0.2ft	0.06m	0.2ft	0.06m
3.0ft	0.91m	134fc	0.4ft	0.12m	0.5ft	0.15m
4.5ft	1.37m	59.6fc	0.6ft	0.18m	0.7ft	0.21m
6.0ft	1.83m	33.5fc	0.8ft	0.24m	0.9ft	0.27m
7.5ft	2.29m	21.5fc	1.1ft	0.33m	1.2ft	0.36m
9.0ft	2.74m	14.9fc	1.3ft	0.39m	1.4ft	0.42m

Delivered Lumen: 46.2 lm
 ■ Vertical Beam Spread: 8.1°
 ■ Horizontal Beam Spread: 8.8°

Polar Candela Distribution

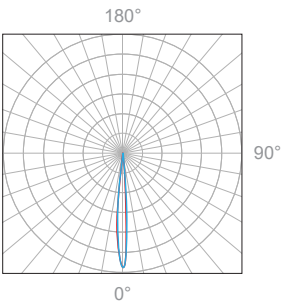

Beam Width: 12°



Illuminance at a Distance

Distance		Center Beam fc	Beam Width			
1.5ft	0.46m	424fc	0.3ft	0.09m	0.3ft	0.09m
3.0ft	0.91m	140fc	0.6ft	0.18m	0.6ft	0.18m
4.5ft	1.37m	62fc	0.9ft	0.27m	0.9ft	0.27m
6.0ft	1.83m	35fc	1.3ft	0.39m	1.3ft	0.39m
7.5ft	2.29m	23fc	1.6ft	0.48m	1.6ft	0.48m
9.0ft	2.74m	16fc	1.9ft	0.58m	1.9ft	0.58m

Delivered Lumen: 63.4 lm
 ■ Vertical Beam Spread: 12°
 ■ Horizontal Beam Spread: 12°

Polar Candela Distribution

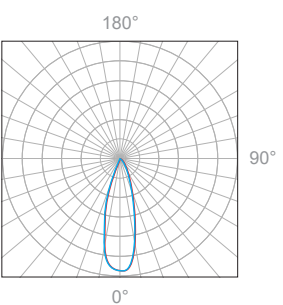

Beam Width: 30°



Illuminance at a Distance

Distance		Center Beam fc	Beam Width			
1.5ft	0.46m	82.3fc	0.8ft	0.24m	0.8ft	0.24m
3.0ft	0.91m	20.6fc	1.6ft	0.49m	1.6ft	0.49m
4.5ft	1.37m	9.14fc	2.4ft	0.73m	2.4ft	0.73m
6.0ft	1.83m	5.14fc	3.2ft	0.98m	3.2ft	0.98m
7.5ft	2.29m	3.29fc	4.0ft	1.22m	4.0ft	1.22m
9.0ft	2.74m	2.29fc	4.7ft	1.43m	4.7ft	1.43m

Delivered Lumen: 65.8 lm
 ■ Vertical Beam Spread: 29.5°
 ■ Horizontal Beam Spread: 29.5°

1W, 3000K, 90+ CRI

Polar Candela Distribution

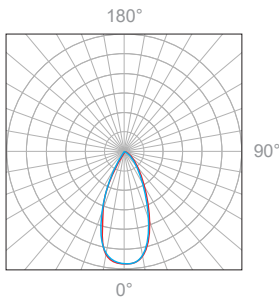

Beam Width: 45°

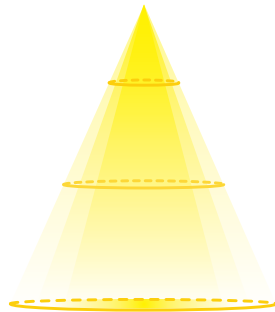

Illuminance at a Distance

Distance		Center Beam fc	Beam Width			
3.0ft	0.91m	12.1fc	2.6ft	0.79m	2.5ft	0.76m
6.0ft	1.83m	3.04fc	5.1ft	1.55m	5.1ft	1.55m
9.0ft	2.74m	1.35fc	7.7ft	2.34m	7.6ft	2.31m
12.0ft	3.65m	0.76fc	10.2ft	3.10m	10.1ft	3.07m
15.0ft	4.57m	0.49fc	12.8ft	3.90m	12.6ft	3.84m
18.0ft	5.48m	0.34fc	15.4ft	4.69m	15.2ft	4.63m

Delivered Lumen: 77.7 lm
 ■ Vertical Beam Spread : 46.2°
 ■ Horizontal Beam Spread : 45.7°

Polar Candela Distribution

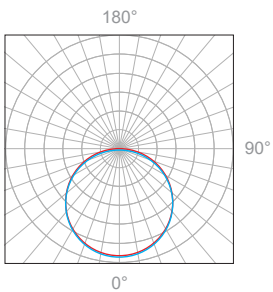

Beam Width: 120°

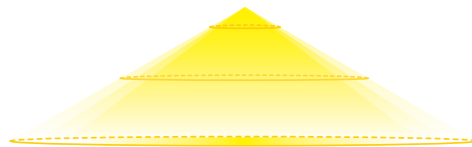

Illuminance at a Distance

Distance		Center Beam fc	Beam Width			
1.5ft	0.46m	11.3fc	4.1ft	1.25m	4.1ft	1.25m
3.0ft	0.91m	2.82fc	8.1ft	2.46m	8.1ft	2.46m
4.5ft	1.37m	1.26fc	12.2ft	3.71m	12.2ft	3.71m
6.0ft	1.83m	0.71fc	16.3ft	4.96m	16.3ft	4.96m
7.5ft	2.29m	0.45fc	20.3ft	6.18m	20.3ft	6.18m
9.0ft	2.74m	0.31fc	24.4ft	7.43m	24.4ft	7.43m

Delivered Lumen: 63 lm
 ■ Vertical Beam Spread : 107.1°
 ■ Horizontal Beam Spread : 107.1°

2W, 3000K, 90+ CRI

Polar Candela Distribution

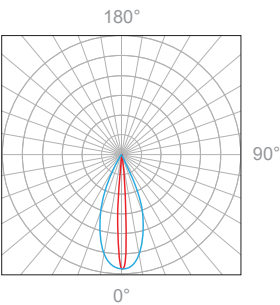

Beam Width: 7° + 36°

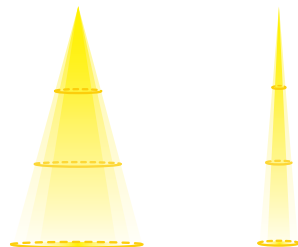

Illuminance at a Distance

Distance		Center Beam fc	Beam Width			
1.5ft	0.46m	165fc	1.0ft	0.30m	0.2ft	0.06m
3.0ft	0.91m	41.3fc	2.0ft	0.61m	0.4ft	0.12m
4.5ft	1.37m	18.3fc	2.9ft	0.88m	0.5ft	0.15m
6.0ft	1.83m	10.3fc	3.9ft	1.18m	0.7ft	0.21m
7.5ft	2.29m	6.60fc	4.9ft	1.49m	0.9ft	0.27m
9.0ft	2.74m	4.59fc	5.9ft	1.79m	1.1ft	0.33m

Delivered Lumen: 49 lm
 ■ Vertical Beam Spread: 36.3°
 ■ Horizontal Beam Spread: 6.8°

Polar Candela Distribution

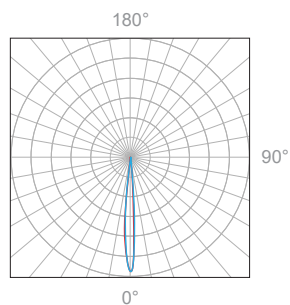

Beam Width: 8°



Illuminance at a Distance

Distance		Center Beam fc	Beam Width			
1.5ft	0.46m	1,015fc	0.2ft	0.06m	0.2ft	0.06m
3.0ft	0.91m	254fc	0.4ft	0.12m	0.4ft	0.12m
4.5ft	1.37m	113fc	0.7ft	0.21m	0.6ft	0.18m
6.0ft	1.83m	63.4fc	0.9ft	0.27m	0.9ft	0.27m
7.5ft	2.29m	40.6fc	1.1ft	0.33m	1.1ft	0.33m
9.0ft	2.74m	28.2fc	1.3ft	0.39m	1.3ft	0.39m

Delivered Lumen: 61.3 lm
 ■ Vertical Beam Spread: 8.5°
 ■ Horizontal Beam Spread: 8.2°

2W, 3000K, 90+ CRI

Polar Candela Distribution

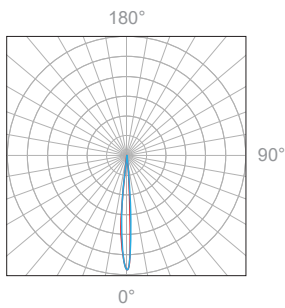

Beam Width: 12°



Illuminance at a Distance

Distance		Center Beam fc	Beam Width			
1.5ft	0.46m	774fc	0.3ft	0.09m	0.3ft	0.09m
3.0ft	0.91m	194fc	0.6ft	0.18m	0.6ft	0.18m
4.5ft	1.37m	86fc	0.9ft	0.27m	0.9ft	0.27m
6.0ft	1.83m	48.4fc	1.3ft	0.39m	1.3ft	0.39m
7.5ft	2.29m	31fc	1.6ft	0.48m	1.6ft	0.48m
9.0ft	2.74m	21.5fc	1.9ft	0.58m	1.9ft	0.58m

Delivered Lumen: 116.8 lm
 ■ Vertical Beam Spread: 12°
 ■ Horizontal Beam Spread: 12°

Polar Candela Distribution

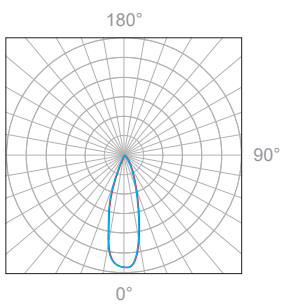

Beam Width: 30°

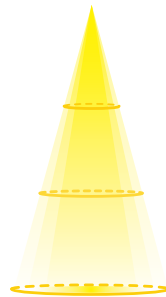

Illuminance at a Distance

Distance		Center Beam fc	Beam Width			
1.5ft	0.46m	152fc	0.8ft	0.24m	0.8ft	0.24m
3.0ft	0.91m	38fc	1.6ft	0.48m	1.6ft	0.48m
4.5ft	1.37m	16.9fc	2.4ft	0.73m	2.4ft	0.73m
6.0ft	1.83m	9.49fc	3.2ft	0.97m	3.2ft	0.97m
7.5ft	2.29m	6.07fc	4.0ft	1.22m	4.0ft	1.22m
9.0ft	2.74m	4.22fc	4.7ft	1.43m	4.7ft	1.43m

Delivered Lumen: 121 lm
 ■ Vertical Beam Spread: 29.5°
 ■ Horizontal Beam Spread: 29.5°

Polar Candela Distribution

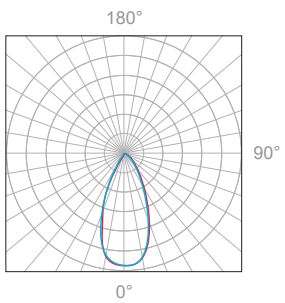

Beam Width: 45°

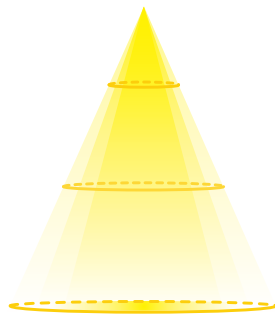

Illuminance at a Distance

Distance		Center Beam fc	Beam Width			
3.0ft	0.91m	21.8fc	2.6ft	0.79m	2.6ft	0.79m
6.0ft	1.83m	5.45fc	5.2ft	1.58m	5.1ft	1.55m
9.0ft	2.74m	2.42fc	7.7ft	2.34m	7.7ft	2.34m
12.0ft	3.65m	1.36fc	10.3ft	3.13m	10.2ft	3.10m
15.0ft	4.57m	0.87fc	12.9ft	3.93m	12.8ft	3.90m
18.0ft	5.48m	0.61fc	15.5ft	4.72m	15.3ft	4.66m

Delivered Lumen: 139.1 lm
 ■ Vertical Beam Spread : 46.5°
 ■ Horizontal Beam Spread : 46.1°

Polar Candela Distribution

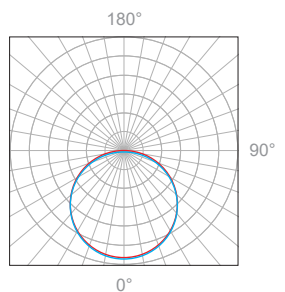

Beam Width: 120°

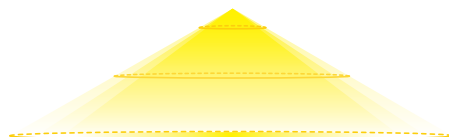

Illuminance at a Distance

Distance		Center Beam fc	Beam Width			
1.5ft	0.46m	21.3fc	4.1ft	1.25m	4.1ft	1.25m
3.0ft	0.91m	5.33fc	8.1ft	2.46m	8.1ft	2.46m
4.5ft	1.37m	2.37fc	12.2ft	3.71m	12.2ft	3.71m
6.0ft	1.83m	1.33fc	16.3ft	4.96m	16.3ft	4.96m
7.5ft	2.29m	0.85fc	20.3ft	6.18m	20.3ft	6.18m
9.0ft	2.74m	0.59fc	24.4ft	7.43m	24.4ft	7.43m

Delivered Lumen: 119 lm
 ■ Vertical Beam Spread : 107.1°
 ■ Horizontal Beam Spread : 107.1°

TM30 Report

2700K, 90+CRI

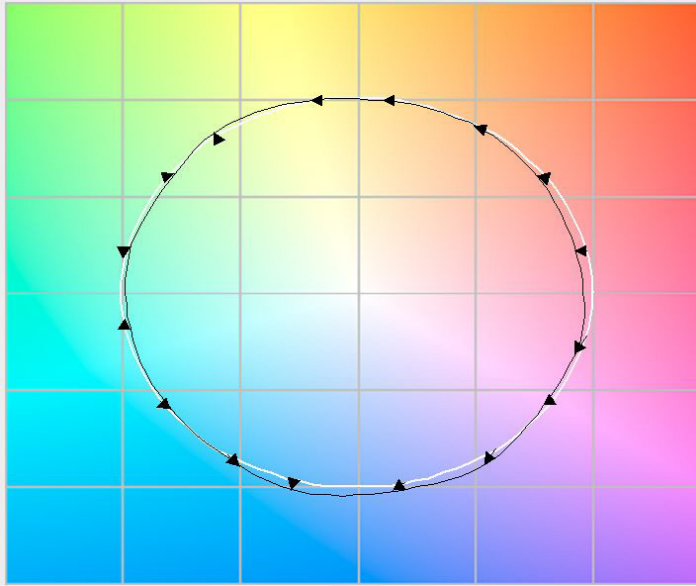

3000K, 90+CRI

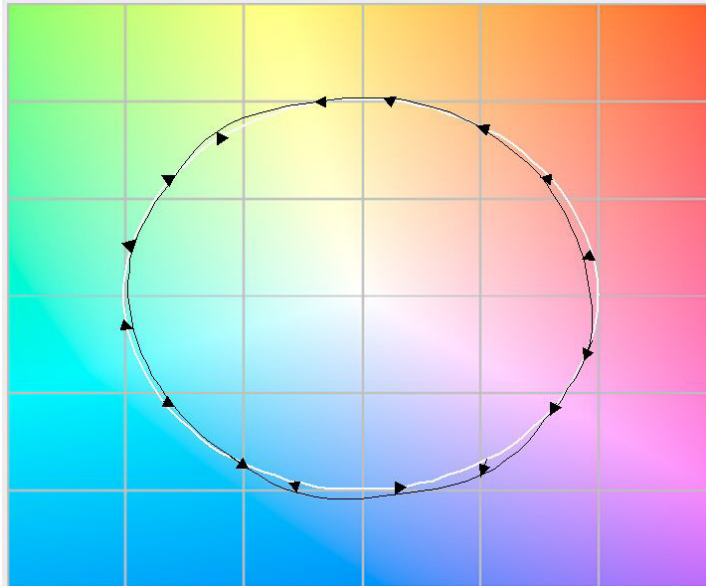

3500K, 90+CRI

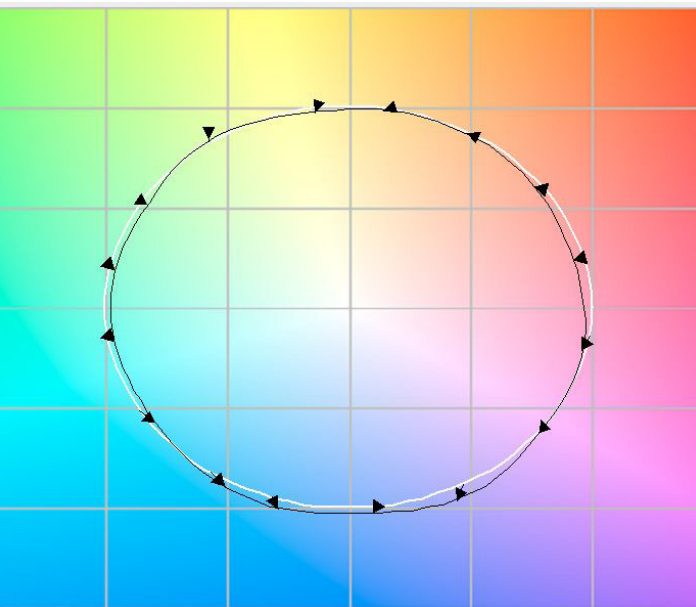

Light Distribution | 10ft Wall | Fixtures installed 6" (152mm) away from the wall

L303 | 1W | 0° angle bracket | 10ft wall | Clear Lens | 3000K

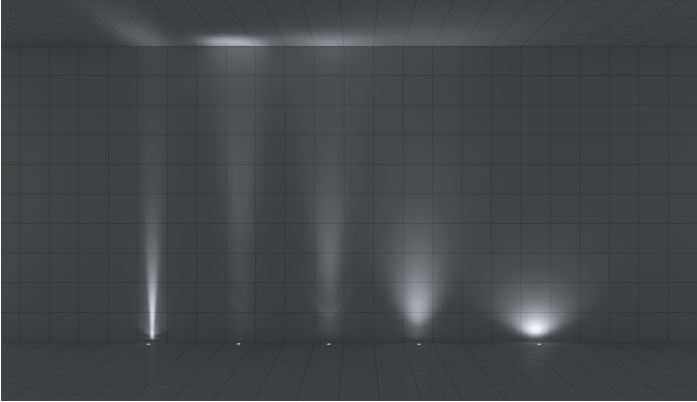

- From left to right:**
E elliptical 7°+ 36°
SS super spot 8°
S spot 12°
N narrow flood 30°
W wide flood 120°

L303 | 1W | 10° angle bracket | 10ft wall | Clear Lens | 3000K

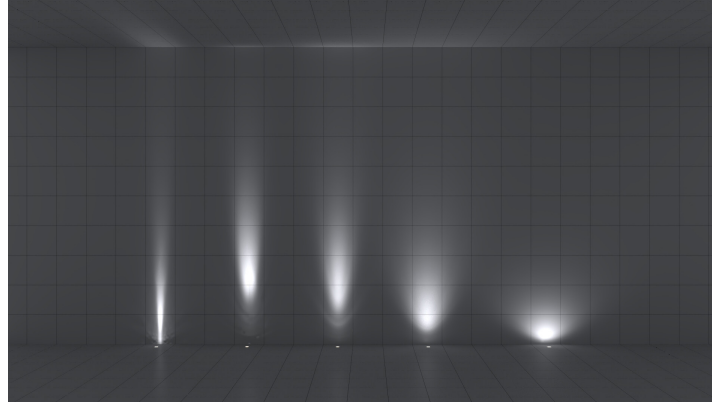

- From left to right:**
E elliptical 7°+ 36°
SS super spot 8°
S spot 12°
N narrow flood 30°
W wide flood 120°

L303 | 2W | 0° angle bracket | 10ft wall | Clear Lens | 3000K

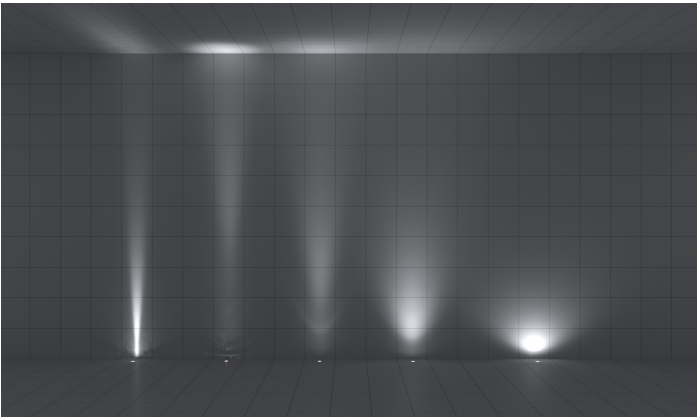

- From left to right:**
E elliptical 7°+ 36°
SS super spot 8°
S spot 12°
N narrow flood 30°
W wide flood 120°

L303 | 2W | 10° angle bracket | 10ft wall | Clear Lens | 3000K

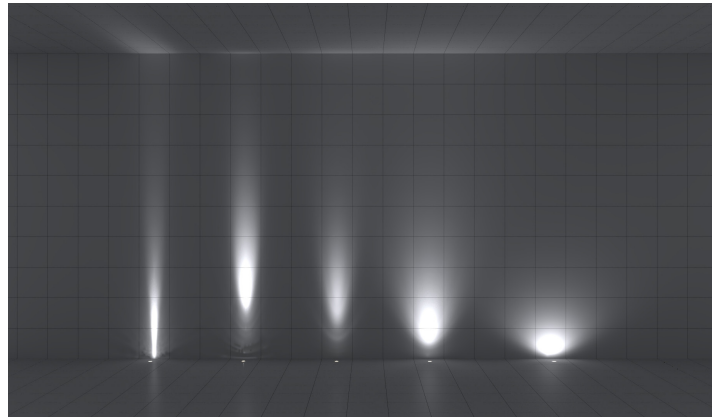

- From left to right:**
E elliptical 7°+ 36°
SS super spot 8°
S spot 12°
N narrow flood 30°
W wide flood 120°

* Images will appear darker when printed.

Light Distribution | 18ft Wall | Fixtures installed 6" (152mm) away from the wall

L303 | 1W | 0° angle bracket | 18ft wall | Clear Lens | 3000K

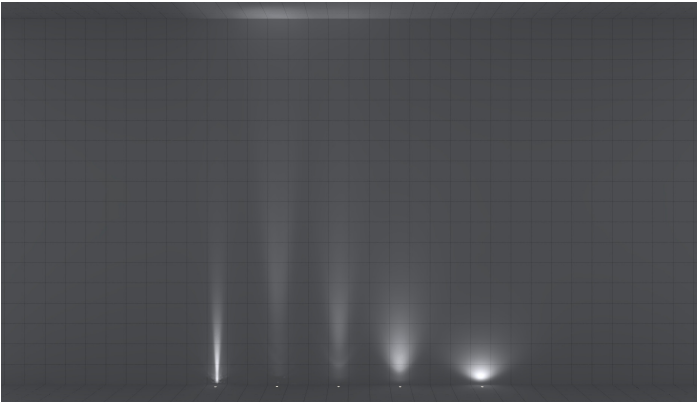

- From left to right:**
E elliptical 7°+ 36°
SS super spot 8°
S spot 12°
N narrow flood 30°
W wide flood 120°

L303 | 1W | 10° angle bracket | 18ft wall | Clear Lens | 3000K

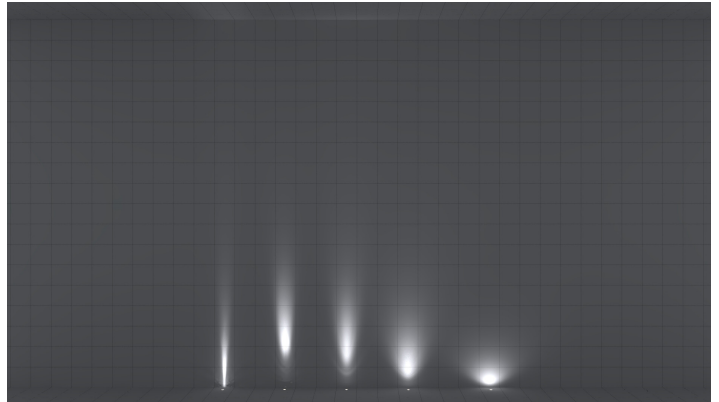

- From left to right:**
E elliptical 7°+ 36°
SS super spot 8°
S spot 12°
N narrow flood 30°
W wide flood 120°

L303 | 2W | 0° angle bracket | 18ft wall | Clear Lens | 3000K

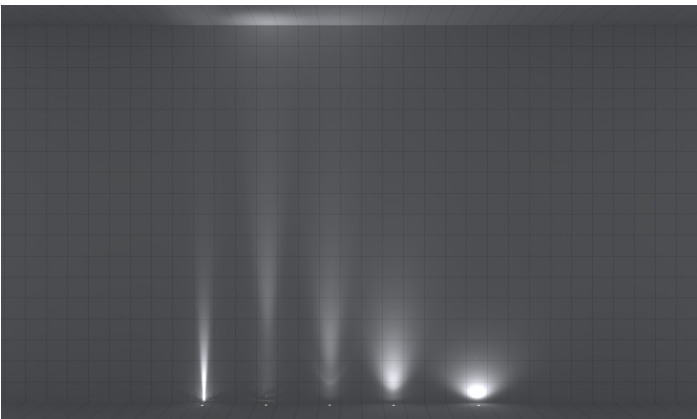

- From left to right:**
E elliptical 7°+ 36°
SS super spot 8°
S spot 12°
N narrow flood 30°
W wide flood 120°

L303 | 2W | 10° angle bracket | 18ft wall | Clear Lens | 3000K

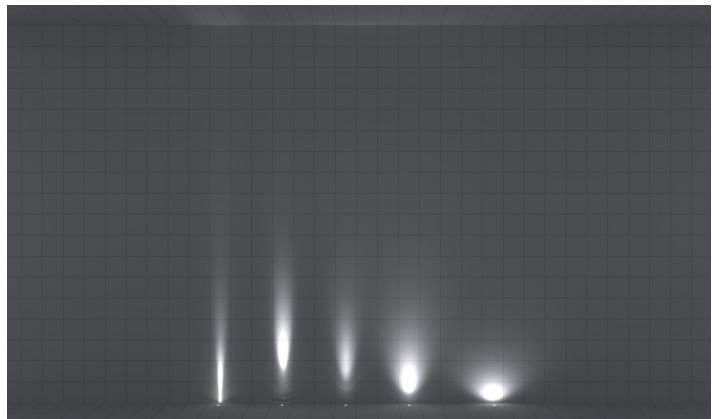

- From left to right:**
E elliptical 7°+ 36°
SS super spot 8°
S spot 12°
N narrow flood 30°
W wide flood 120°

Appendix

Aluminum Finishes



MA matte clear anodized



BA black anodized

Stainless Steel Finishe



S6 stainless steel 316

Accessories



LM louver, matte clear anodized



LB louver, black anodized



HM hex louver, matte clear anodized



HB hex louver, black anodized



AB angled louver, black anodized



SB straight louver, black anodized



QB square louver, black anodized



RB ring louver, black anodized

Lens Options

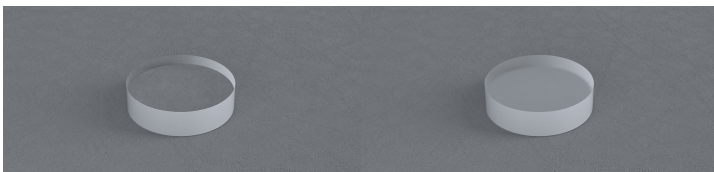

C clear lens

F frosted