

# PIPE-C

## EXTERIOR

PVC Pipe | For landscaping

- Wet, Damp, and Dry location



### Ordering Information

Clear Form

Date : \_\_\_\_\_

Quantity : \_\_\_\_\_

Project : \_\_\_\_\_

Note : \_\_\_\_\_

Type : \_\_\_\_\_

### Specifications

**PVC Pipe** | Example Code: PIPE-C

Product <sup>1</sup>

**PIPE-C**

### System Components (Ordered Separately)

Back Box : \_\_\_\_\_

\* Please refer to Appendix for more information.

- EBX-OCT1-CPIPE** MP Lighting back box with PIPE-C attached.
- EBX-SFD-CPIPE** Scepter FD back box with PIPE-C attached.

### Important Notes

#### Specification

- Factory set length of 11-13/16" (300mm). See pg.2 for dimensions..

### Application

Environment	Dry / Damp / Wet Location approved.
Mounting	Designed to be mounted to electrical and/or landscape pipes. Field cuttable. Compatible with couplings, elbows, t-junction fittings for standard 1-1/2" PVC pipe (outer diameter 1-7/8", schedule 40, 80 and furniture grade pvc pipes.
Compatible Fixtures	<b>In-grade:</b> L01, L08, L300, L304, L312, L320 & L324. <b>Spotlight:</b> L930 B2 See pg.3 for product images of compatible fixtures. See pg.4-5 for application images of compatible fixtures.

### Product Construction

Weight	0.5 lbs (0.23 kg) per 11-13/16" (300mm)
Material	Black PVC, UV stabilized

Mounting Options & Dimensions

PIPE-C Dimensions

Dimensions

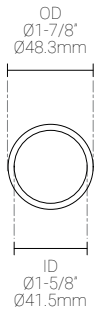

Length

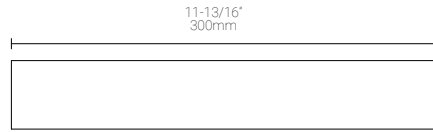

3D View



Installation (shown with L01)

Fixture (L01)

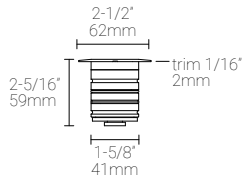

PIPE-C with L01

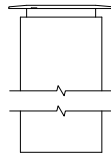

Pipe with Back Boxes

EBX-OCT1-CPIPE : MP Lighting back box with PIPE-01-BK attached

EBX-SFD-CPIPE : Scepter FD back box with PIPE-01-BK attached

3D View

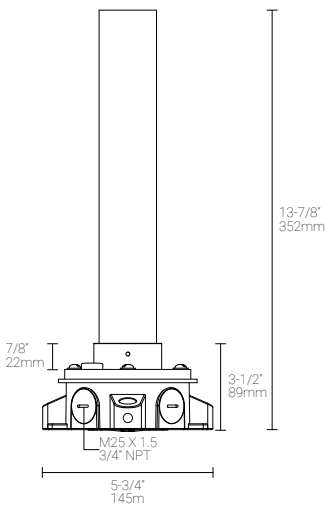

3D View

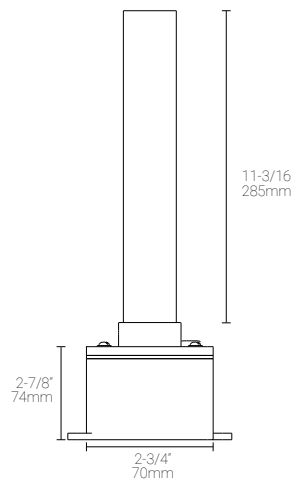

Compatible Fixtures

In-grade

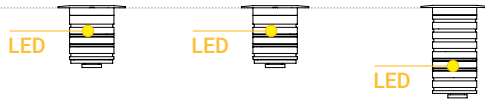

Regular Beam



L01 ●

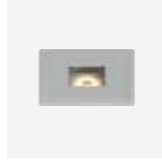

L304 ●

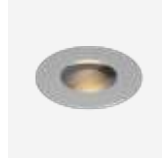

L312 ●



Half-Shielded

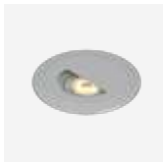

L300 ●



Single Aperture



L08-S ●



Double Aperture



L08-D ●

Spotlights



L930 with B2 ●  
(Schedule 40 Pipe)

Shroud Options

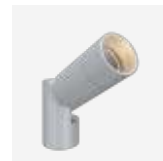

DS - Dry Location  
Shroud



WS - Wet Location  
Shroud

In-grade Installation

L01 | Landscape | During Installation



L01 | Landscape | Complete Installation



L01 | Stairs/Wall | During Installation



L01 | Stairs/Wall | Complete Installation



L01 | Stairs/Ground | During Installation



L01 | Stairs/Ground | Complete Installation



\* Images will appear darker when printed.

Spotlight Installation

L930 B2 | Landscape | During Installation



L930 B2 | Landscape | Complete Installation



*\* Images will appear darker when printed.*