

# L315

## INTERIOR

In-grade | For ground, ceilings, walls, and stairs

● Dry location

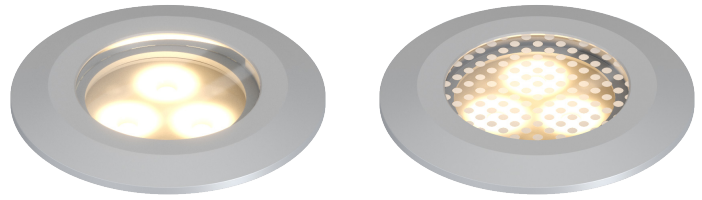

### Ordering Information

Clear Form

Date : \_\_\_\_\_

Quantity : \_\_\_\_\_

Project : \_\_\_\_\_

Note : \_\_\_\_\_

Type : \_\_\_\_\_

### Specifications

Luminaire | Example Code: L315-7-W30H-N-C-0-[ ]-S6

Product	Version	CCT & CRI <sup>1</sup>	Beam Angle <sup>2</sup>	Lens	Accessories <sup>4</sup> (optional)	Internal Angle Bracket <sup>5</sup>	Trim Finish <sup>6</sup>
<b>L315</b>							
	3 1Wx3 7 2.5Wx3	<b>W22S</b> 2200K 80+ <b>W27H</b> 2700K 90+ <b>W30H</b> 3000K 90+ <b>W35H</b> 3500K 90+ <b>W41H</b> 4100K 90+	<b>S</b> spot 12° <b>N</b> narrow flood 30° <b>F</b> flood 60°	<b>C</b> clear <b>F</b> frosted <b>A</b> anti-slip <sup>3</sup>	<b>HM2</b> hex louver, matte anodized <b>HB2</b> hex louver, black anodized <b>AB2</b> angled louver, black anodized <b>SB2</b> straight louver, black anodized <b>QB2</b> square louver, black anodized <b>RB2</b> ring louver, black anodized <b>NB2</b> narrow louver, black	<b>0</b> no angle <b>30</b> 30° angle <b>X</b> custom	<b>Aluminum Finishes:</b> <b>MA</b> matte clear anodized <b>BA</b> black anodized <b>BZ</b> bronze powder coated  <b>Stainless Steel Finishes:</b> <b>S6</b> stainless steel 316 <b>BT0</b> black stainless steel  <b>Other Materials:</b> <b>ABZ</b> antique bronze

### System Components (Ordered Separately)

Remote Driver : \_\_\_\_\_

\* Consult MP Lighting Website or Factory.

### Important Notes

#### Specification

1. Refer to pg.2 - for Light Quality and Colour Consistency.
2. See Light Distribution section for illustration of different combinations of beam angles and angle bracket.
3. Anti-slip is only available with Clear lens. Refer to Appendix or MP Lighting website for images and details.
4. Louvers will be below the lens. AB2/SB2/QB2/RB2/NB2/ Only available when there is no Internal Angle Bracket.
5. Internal angle bracket is factory set, and cannot be field adjusted. 5° increments to maximum of 30° without accessories. Maximum 15° angle with accessories.
6. Different finish options are only applicable to trim ring and not for LED module housing. Refer to Appendix or MP Lighting website for complete look of luminaire with different trim finish options.

#### Warranty Notes & Disclaimer

Malfunction and damage to product due to incompatible dimming system or misuse will not be covered under warranty. Consult MP Lighting for recommended drivers. If the fixture has an option to be installed with a dimming control system, consult a dimming system manufacturer with minimum load before installing. MP Lighting reserves the right, at its sole discretion, at any time and without notice, to make design changes to any of our products. Consult MP Lighting website for most updated documentation.

# L315

## INTERIOR

In-grade | For ground, ceilings, walls, and stairs

● Dry location

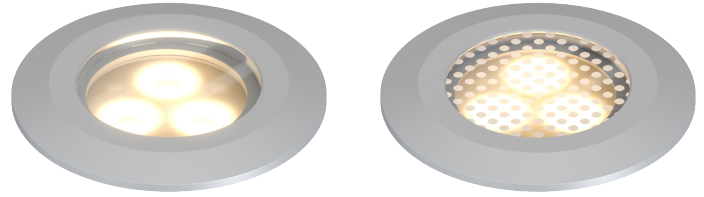

### Performance

Wattage	Forward Current	Power Consumption Budget per fixture (including driver)	LED output (Source)	Fixture Output (Delivered)
3W	350mA	3.0W	330 lm	254-277 lm
7.5W	700mA	7.5W	825 lm	459-492 lm

### Application

Environment	Dry Location approved. IP40.
Mounting	Comes with a steel flange that mounts to pre-installed standard 4" (102mm) octagonal box, 1-1/2"(38mm) deep minimum, and 1/4"(6mm) setback from face of finished surface material. Can be wall or ceiling mounted.

### Electrical

Power Supplies	Remote LED drivers (120-277V AC input, <b>constant current output</b> ): Fixtures to be wired in series. Remote LED drivers (120-277V AC input, <b>constant voltage output</b> ): Fixtures to be wired in parallel.
Control	<b>On/off control</b> <b>Dimming:</b> ELV or 0-10V dimming with appropriate drivers <b>Other options (consult factory):</b> TRIAC/MLV, DMX, DALI, Casambi, Power over Ethernet

### Luminaire Construction

LED Light Source	<b>W22S</b> = CCT: 2200K, CRI (Ra): 80+, Colour Consistency: 3SDCM <b>W27H</b> = CCT: 2700K, CRI (Ra): 90+, Colour Consistency: 2SDCM <b>W30H</b> = CCT: 3000K, CRI (Ra): 90+, Colour Consistency: 2SDCM <b>W35H</b> = CCT: 3500K, CRI (Ra): 90+, Colour Consistency: 2SDCM <b>W41H</b> = CCT: 4100K, CRI (Ra): 90+, Colour Consistency: 3SDCM
Weight	2.56 lbs (1.16 kg). Typical Aluminum Insert & Back Box only.
Material	<b>Fixture:</b> machined marine-grade aluminum, machined stainless steel (316) or antique bronze with tempered glass
Supplied with	<b>Standard installation housing:</b> Comes with a steel mounting flange.
Warranty & LED Life	5 years limited warranty Estimated useful life of LED is 50,000 hours.

### Ordered Separately

System Components	<b>Power supplies:</b> remote driver Please consult factory or visit <a href="#">Recommended Drivers</a> for available driver options.
-------------------	---

Mounting Options & Dimensions

LED Insert Dimensions

Fixture

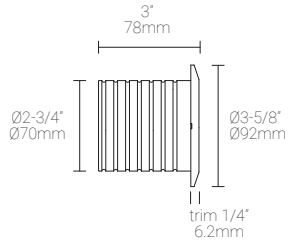

Top View

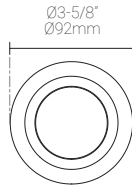

3D View



Beam

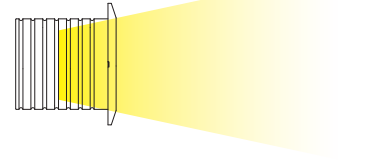

Ceiling, Wall, and Stair Riser Installation (shown with a mounting flange)

Wall installation shown with a mounting flange

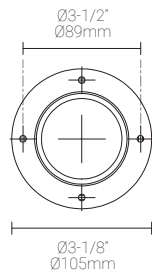
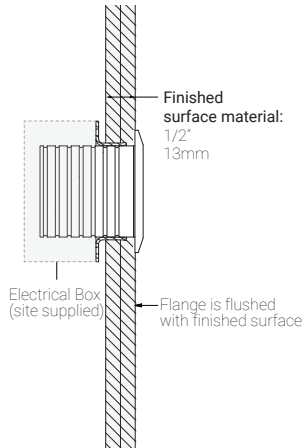

3W, 3000K, 90+ CRI

Polar Candela Distribution

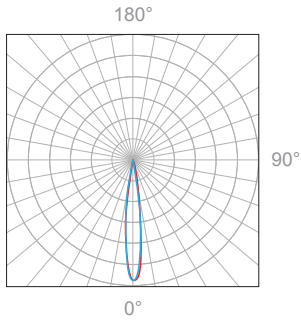

Beam Width: 12°



Illuminance at a Distance

Distance		Center Beam	Beam Width			
3.0ft	0.91m	221fc	0.9ft	0.27m	0.9ft	0.27m
6.0ft	1.83m	55.2fc	1.8ft	0.54m	1.8ft	0.54m
9.0ft	2.74m	24.6fc	2.7ft	0.82m	2.6ft	0.79m
12ft	3.66m	13.8fc	3.5ft	1.06m	3.5ft	1.06m
15ft	4.57m	8.84fc	4.4ft	1.34m	4.4ft	1.34m
18ft	5.49m	6.14fc	5.3ft	1.61m	5.3ft	1.61m

Delivered Lumen: 277.2 lm  
 ■ Vertical Beam Spread : 16.8°  
 ■ Horizontal Beam Spread : 16.7°

Polar Candela Distribution

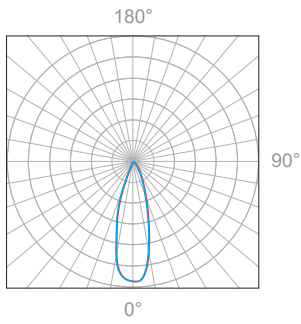

Beam Width: 30°

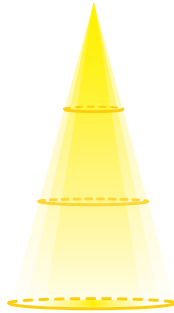

Illuminance at a Distance

Distance		Center Beam	Beam Width			
3.0ft	0.91m	206fc	1.0ft	0.30m	1.0ft	0.30m
6.0ft	1.83m	51.5fc	2.1ft	0.64m	2.0ft	0.61m
9.0ft	2.74m	22.9fc	3.1ft	0.94m	3.0ft	0.91m
12ft	3.66m	12.9fc	4.1ft	1.25m	4.0ft	1.22m
15ft	4.57m	8.25fc	5.1ft	1.55m	5.0ft	1.52m
18ft	5.49m	5.73fc	6.2ft	1.89m	6.0ft	1.82m

Delivered Lumen: 271.5 lm  
 ■ Vertical Beam Spread : 19.5°  
 ■ Horizontal Beam Spread : 19.0°

Polar Candela Distribution

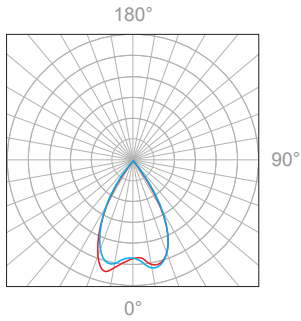

Beam Width: 60°

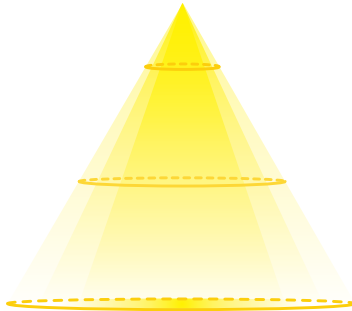

Illuminance at a Distance

Distance		Center Beam	Beam Width			
3.0ft	0.91m	42.9fc	2.3ft	0.70m	2.4ft	0.73m
6.0ft	1.83m	10.7fc	4.6ft	1.40m	4.8ft	1.46m
9.0ft	2.74m	4.76fc	6.9ft	2.10m	7.1ft	2.16m
12ft	3.66m	2.68fc	9.2ft	2.80m	9.5ft	2.89m
15ft	4.57m	1.72fc	11.5ft	3.50m	11.9ft	3.62m
18ft	5.49m	1.19fc	13.8ft	4.20m	14.3ft	4.35m

Delivered Lumen: 254.4 lm  
 ■ Vertical Beam Spread : 42.0°  
 ■ Horizontal Beam Spread : 43.3°

Polar Candela Distribution

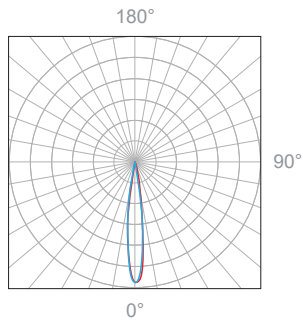

Beam Width: 12°



Illuminance at a Distance

Distance		Center Beam	Beam Width			
3.0ft	0.91m	392fc	0.9ft	0.27m	0.9ft	0.27m
6.0ft	1.83m	97.9fc	1.8ft	0.54m	1.7ft	0.51m
9.0ft	2.74m	43.5fc	2.6ft	0.79m	2.6ft	0.79m
12ft	3.66m	24.5fc	3.5ft	1.06m	3.5ft	1.06m
15ft	4.57m	15.7fc	4.4ft	1.34m	4.4ft	1.34m
18ft	5.49m	10.9fc	5.3ft	1.61m	5.2ft	1.58m

Delivered Lumen: 491.5 lm  
 ■ Vertical Beam Spread : 16.7°  
 ■ Horizontal Beam Spread : 16.5°

Polar Candela Distribution

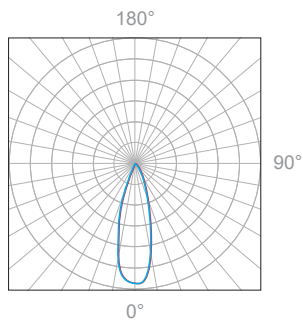

Beam Width: 30°



Illuminance at a Distance

Distance		Center Beam	Beam Width			
3.0ft	0.91m	367fc	1.1ft	0.33m	1.0ft	0.30m
6.0ft	1.83m	91.7fc	2.1ft	0.64m	2.0ft	0.61m
9.0ft	2.74m	40.8fc	3.2ft	0.97m	3.0ft	0.91m
12ft	3.66m	22.9fc	4.2ft	1.28m	4.0ft	1.22m
15ft	4.57m	14.7fc	5.3ft	1.61m	5.0ft	1.52m
18ft	5.49m	10.2fc	6.3ft	1.92m	6.0ft	1.82m

Delivered Lumen: 484.3 lm  
 ■ Vertical Beam Spread : 19.9°  
 ■ Horizontal Beam Spread : 18.9°

Polar Candela Distribution

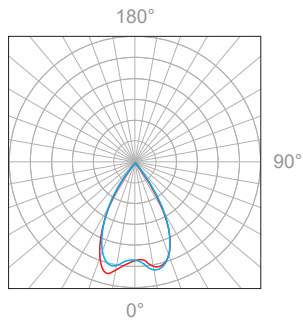

Beam Width: 60°

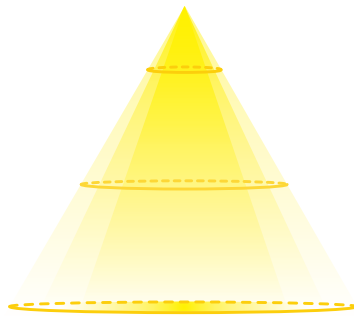

Illuminance at a Distance

Distance		Center Beam	Beam Width			
3.0ft	0.91m	76.8fc	2.5ft	0.76m	2.3ft	0.70m
6.0ft	1.83m	19.2fc	5.0ft	1.52m	4.5ft	1.37m
9.0ft	2.74m	8.54fc	7.5ft	2.28m	6.8ft	2.07m
12ft	3.66m	4.80fc	10.0ft	3.04m	9.1ft	2.77m
15ft	4.57m	3.07fc	12.5ft	3.81m	11.3ft	3.44m
18ft	5.49m	2.13fc	15.0ft	4.57m	13.6ft	4.14m

Delivered Lumen: 458.7 lm  
 ■ Vertical Beam Spread : 45.4°  
 ■ Horizontal Beam Spread : 41.4°

Appendix

Aluminum Finishes

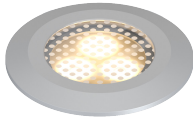

MA matte clear anodized with anti-slip lens



BA black anodized



BZ bronze powder coated

Stainless Steel Finishes



S6 stainless steel 316



BT0 black stainless steel

Other Materials

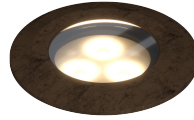

ABZ antique bronze

Accessories

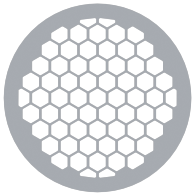

HM2 hex louver, matte clear anodized

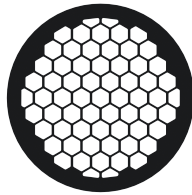

HB2 hex louver, black anodized



AB2 angled louver, black anodized

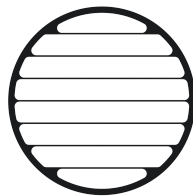

SB2 straight louver, black anodized

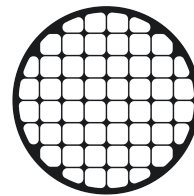

QB2 square louver, black anodized

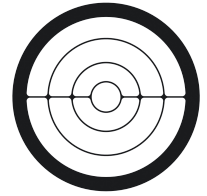

RB2 ring louver, black anodized

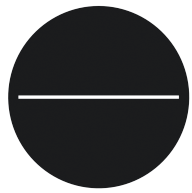

NB2 narrow beam louver, black

Lens Options



C clear lens

F frosted

A anti-slip