

# L340

EXTERIOR | INTERIOR

In-grade | For decks, ceilings, walls, and stairs

• Wet, Damp, and Dry Location



## Ordering Information

Clear Form

Date : \_\_\_\_\_

Quantity : \_\_\_\_\_

Project : \_\_\_\_\_

Note : \_\_\_\_\_

Type : \_\_\_\_\_

## Specifications

Luminaire | Example Code: L340-2-W30H-N-C-[ ]-0-S6

| Product     | Wattage      | CCT & CRI   | Beam Angle <sup>1</sup>   | Lens  | Accessories <sup>3</sup> (optional)  | Internal Angle Bracket <sup>4</sup>                         | Trim Finish   |
|-------------|--------------|---|---|---|--|---|---|
| <b>L340</b> |              |   |   |   |  |   | <b>S6</b>   |
|             | 1 1W<br>2 2W | <b>W22S</b> 2200K 80+<br><b>W27H</b> 2700K 90+<br><b>W30H</b> 3000K 90+<br><b>W35H</b> 3500K 90+<br><b>W41H</b> 4100K 90+ | <b>E</b> elliptical 7°+36°<br><b>SS</b> super spot 8°<br><b>S</b> spot 12°<br><b>N</b> narrow flood 30°<br><b>F</b> flood 45°<br><b>W</b> wide flood 120° | <b>C</b> clear<br><b>F</b> frosted<br><b>A</b> anti-slip <sup>2</sup> | <b>LM</b> louver, matte anodized<br><b>LB</b> louver, black anodized<br><b>HM</b> hex louver, matte anodized<br><b>HB</b> hex louver, black anodized<br><b>AB</b> angled louver, black anodized<br><b>SB</b> straight louver, black anodized<br><b>QB</b> square louver, black anodized<br><b>RB</b> ring louver, black anodized | <b>0</b> no angle<br><b>15</b> 15° angle<br><b>X</b> custom | <b>Stainless Steel Finish:</b><br><b>S6</b> stainless steel 316 |

## System Components (Ordered Separately)

Remote Driver : \_\_\_\_\_

\* Consult MP Lighting Website or Factory.

## Important Notes

### Specification

- Refer to pg.02 - Electrical for Light Quality & Colour Consistency details.
- See Light Distribution section for illustration of different combinations of beam angles and angle bracket.
- Anti-slip is only available with Clear lens. Refer to Appendix or MP Lighting website for images and details.
- Louvers will be below the glass cover. Only available when there is no Internal Angle Bracket.
- Internal angle bracket is factory set, and cannot be field adjusted. 5° increments to maximum of 20° without accessories.

### Warranty Notes & Disclaimer

Malfunction and damage to product due to incompatible dimming system or misuse will not be covered under warranty. Consult MP Lighting for recommended drivers. If the fixture has an option to be installed with a dimming control system, consult a dimming system manufacturer with minimum load before installing. MP Lighting reserves the right, at its sole discretion, at any time and without notice, to make design changes to any of our products. Consult MP Lighting website for most updated documentation.

# L340

EXTERIOR | INTERIOR

In-grade | For decks, ceilings, walls, and stairs

- Wet, Damp, and Dry location



## Performance

| Wattage | Forward Current | Power Consumption Budget per fixture (including driver) | LED output (Source) | Fixture Output (Delivered) |
|---------|-----------------|---|---------------------|----------------------------|
| 1W      | 350mA           | 1.3W  | 110 lm              | 47~62 lm                   |
| 2W      | 700mA           | 2.6W  | 220 lm              | 75~78 lm                   |

## Application

|                   |   |
|-------------------|---|
| Environment       | Wet / Damp / Dry Location approved. IP 68.  |
| Drive Over Rating | 9,700 lbs (4,400 kg)  |
| Mounting          | <b>Recessed:</b> Designed to be inserted into the surface and secured with two screws (included). |

## Electrical

|                |  |
|----------------|--|
| Power Supplies | Remote LED drivers (120-277V AC input, <b>constant current output</b> ): Fixtures to be wired in series.   |
| Control        | <b>On/off control   Dimming:</b> ELV or 0-10V dimming with appropriate drivers<br><b>Other options (consult factory):</b> TRIAC/MLV, DMX, DALI, Casambi, Power over Ethernet |

## Luminaire Construction

|                     |  |
|---------------------|--|
| LED Light Source    | <b>W22S</b> = CCT: 2200K, CRI (Ra): 80+, Colour Consistency: 3SDCM<br><b>W27H</b> = CCT: 2700K, CRI (Ra): 90+, Colour Consistency: 2SDCM<br><b>W30H</b> = CCT: 3000K, CRI (Ra): 90+, Colour Consistency: 2SDCM<br><b>W35H</b> = CCT: 3500K, CRI (Ra): 90+, Colour Consistency: 2SDCM<br><b>W41H</b> = CCT: 4100K, CRI (Ra): 90+, Colour Consistency: 3SDCM |
| Standard Compliance | ✓ADA-compliant ✓WELL standard – Feature 58: Color Quality  |
| Weight              | N/A  |
| Material            | <b>Fixture:</b> machined stainless steel (316)   |
| Supplied with       | <b>Standard installation housing:</b> Comes with two pointed end self-tapping #8-32 screws.<br><b>Cable:</b> 6" (152mm) factory-installed wire lead  |
| Warranty & LED Life | 5 years limited warranty<br>Estimated useful life of LED is 50,000 hours.  |

## Ordered Separately

|                   |   |
|-------------------|---|
| System Components | <b>Power supplies:</b> remote driver<br>Please consult factory or visit <a href="#">Recommended Drivers</a> for available driver options. |
|-------------------|---|

## Mounting Options & Dimensions

### LED Insert Dimensions

Fixture

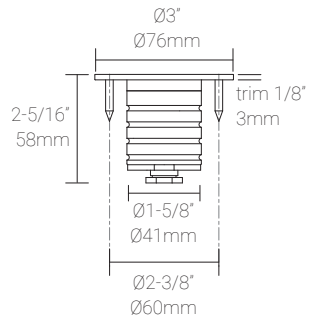

Top View

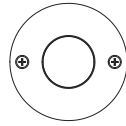

3D View



Beam



### Installation with screws

Fixture with self-tapping screws:  
During Installation

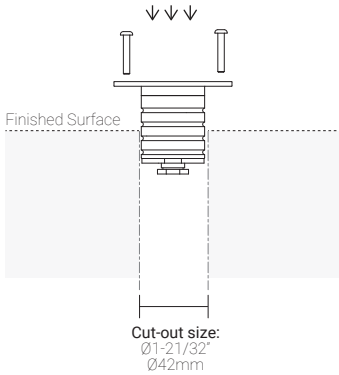

Fixture with self-tapping screws:  
Complete Installation

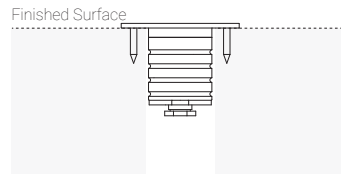

Two pointed end self-tapping  
#8-32 screws provided.

1W, 3000K, 90+ CRI

Polar Candela Distribution

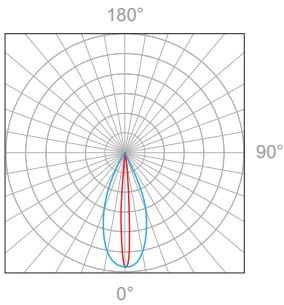

Beam Width: 7° + 36°

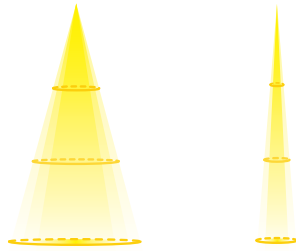

Illuminance at a Distance

| Distance |       | Center Beam fc | Beam Width |       |       |       |
|----------|-------|----------------|------------|-------|-------|-------|
| 1.5ft    | 0.46m | 92.9fc         | 1.0ft      | 0.30m | 0.2ft | 0.06m |
| 3.0ft    | 0.91m | 23.2fc         | 2.0ft      | 0.61m | 0.4ft | 0.12m |
| 4.5ft    | 1.37m | 10.3fc         | 2.9ft      | 0.88m | 0.5ft | 0.15m |
| 6.0ft    | 1.83m | 5.81fc         | 3.9ft      | 1.18m | 0.7ft | 0.21m |
| 7.5ft    | 2.29m | 3.72fc         | 4.9ft      | 1.49m | 0.9ft | 0.27m |
| 9.0ft    | 2.74m | 2.58fc         | 5.9ft      | 1.79m | 1.0ft | 0.30m |

Delivered Lumen: 27 lm  
 ■ Vertical Beam Spread: 36.1°  
 ■ Horizontal Beam Spread: 6.7°

Polar Candela Distribution

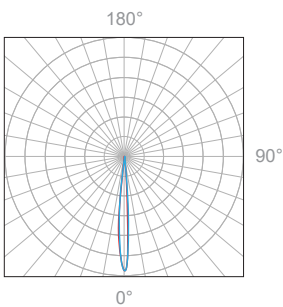

Beam Width: 8°



Illuminance at a Distance

| Distance |       | Center Beam fc | Beam Width |       |       |       |
|----------|-------|----------------|------------|-------|-------|-------|
| 1.5ft    | 0.46m | 537fc          | 0.2ft      | 0.06m | 0.2ft | 0.06m |
| 3.0ft    | 0.91m | 134fc          | 0.4ft      | 0.12m | 0.5ft | 0.15m |
| 4.5ft    | 1.37m | 59.6fc         | 0.6ft      | 0.18m | 0.7ft | 0.21m |
| 6.0ft    | 1.83m | 33.5fc         | 0.8ft      | 0.24m | 0.9ft | 0.27m |
| 7.5ft    | 2.29m | 21.5fc         | 1.1ft      | 0.33m | 1.2ft | 0.36m |
| 9.0ft    | 2.74m | 14.9fc         | 1.3ft      | 0.39m | 1.4ft | 0.42m |

Delivered Lumen: 46.2 lm  
 ■ Vertical Beam Spread: 8.1°  
 ■ Horizontal Beam Spread: 8.8°

Polar Candela Distribution

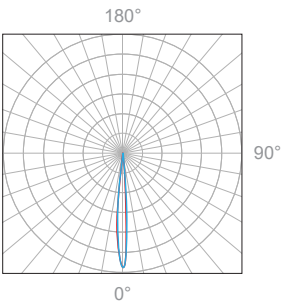

Beam Width: 12°



Illuminance at a Distance

| Distance |       | Center Beam fc | Beam Width |       |       |       |
|----------|-------|----------------|------------|-------|-------|-------|
| 1.5ft    | 0.46m | 424fc          | 0.3ft      | 0.09m | 0.3ft | 0.09m |
| 3.0ft    | 0.91m | 140fc          | 0.6ft      | 0.18m | 0.6ft | 0.18m |
| 4.5ft    | 1.37m | 62fc           | 0.9ft      | 0.27m | 0.9ft | 0.27m |
| 6.0ft    | 1.83m | 35fc           | 1.3ft      | 0.39m | 1.3ft | 0.39m |
| 7.5ft    | 2.29m | 23fc           | 1.6ft      | 0.48m | 1.6ft | 0.48m |
| 9.0ft    | 2.74m | 16fc           | 1.9ft      | 0.58m | 1.9ft | 0.58m |

Delivered Lumen: 63.4 lm  
 ■ Vertical Beam Spread: 12°  
 ■ Horizontal Beam Spread: 12°

Polar Candela Distribution

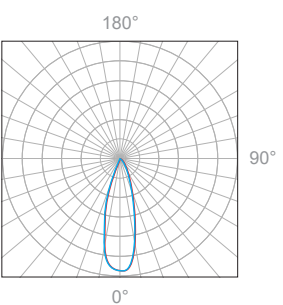

Beam Width: 30°



Illuminance at a Distance

| Distance |       | Center Beam fc | Beam Width |       |       |       |
|----------|-------|----------------|------------|-------|-------|-------|
| 1.5ft    | 0.46m | 82.3fc         | 0.8ft      | 0.24m | 0.8ft | 0.24m |
| 3.0ft    | 0.91m | 20.6fc         | 1.6ft      | 0.49m | 1.6ft | 0.49m |
| 4.5ft    | 1.37m | 9.14fc         | 2.4ft      | 0.73m | 2.4ft | 0.73m |
| 6.0ft    | 1.83m | 5.14fc         | 3.2ft      | 0.98m | 3.2ft | 0.98m |
| 7.5ft    | 2.29m | 3.29fc         | 4.0ft      | 1.22m | 4.0ft | 1.22m |
| 9.0ft    | 2.74m | 2.29fc         | 4.7ft      | 1.43m | 4.7ft | 1.43m |

Delivered Lumen: 65.8 lm  
 ■ Vertical Beam Spread: 29.5°  
 ■ Horizontal Beam Spread: 29.5°

1W, 3000K, 90+ CRI

Polar Candela Distribution

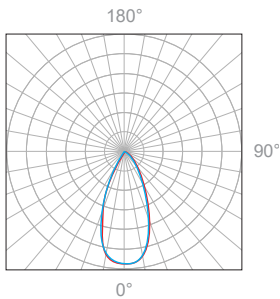

Beam Width: 45°

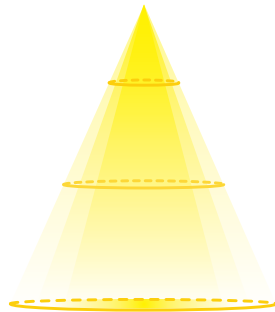

Illuminance at a Distance

| Distance |       | Center Beam fc | Beam Width |       |        |       |
|----------|-------|----------------|------------|-------|--------|-------|
| 3.0ft    | 0.91m | 12.1fc         | 2.6ft      | 0.79m | 2.5ft  | 0.76m |
| 6.0ft    | 1.83m | 3.04fc         | 5.1ft      | 1.55m | 5.1ft  | 1.55m |
| 9.0ft    | 2.74m | 1.35fc         | 7.7ft      | 2.34m | 7.6ft  | 2.31m |
| 12.0ft   | 3.65m | 0.76fc         | 10.2ft     | 3.10m | 10.1ft | 3.07m |
| 15.0ft   | 4.57m | 0.49fc         | 12.8ft     | 3.90m | 12.6ft | 3.84m |
| 18.0ft   | 5.48m | 0.34fc         | 15.4ft     | 4.69m | 15.2ft | 4.63m |

Delivered Lumen: 77.7 lm  
 ■ Vertical Beam Spread : 46.2°  
 ■ Horizontal Beam Spread : 45.7°

Polar Candela Distribution

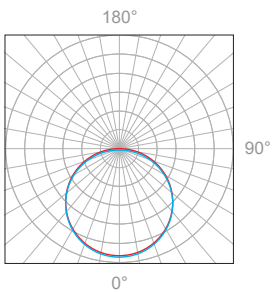

Beam Width: 120°

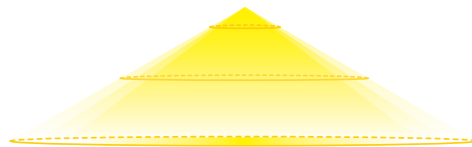

Illuminance at a Distance

| Distance |       | Center Beam fc | Beam Width |       |        |       |
|----------|-------|----------------|------------|-------|--------|-------|
| 1.5ft    | 0.46m | 11.3fc         | 4.1ft      | 1.25m | 4.1ft  | 1.25m |
| 3.0ft    | 0.91m | 2.82fc         | 8.1ft      | 2.46m | 8.1ft  | 2.46m |
| 4.5ft    | 1.37m | 1.26fc         | 12.2ft     | 3.71m | 12.2ft | 3.71m |
| 6.0ft    | 1.83m | 0.71fc         | 16.3ft     | 4.96m | 16.3ft | 4.96m |
| 7.5ft    | 2.29m | 0.45fc         | 20.3ft     | 6.18m | 20.3ft | 6.18m |
| 9.0ft    | 2.74m | 0.31fc         | 24.4ft     | 7.43m | 24.4ft | 7.43m |

Delivered Lumen: 63 lm  
 ■ Vertical Beam Spread : 107.1°  
 ■ Horizontal Beam Spread : 107.1°

2W, 3000K, 90+ CRI

Polar Candela Distribution

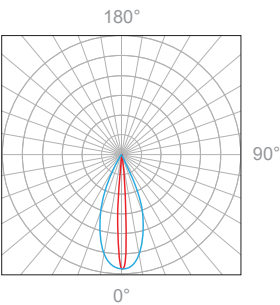

Beam Width: 7° + 36°

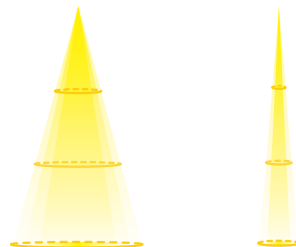

Illuminance at a Distance

| Distance |       | Center Beam fc | Beam Width |       |       |       |
|----------|-------|----------------|------------|-------|-------|-------|
| 1.5ft    | 0.46m | 165fc          | 1.0ft      | 0.30m | 0.2ft | 0.06m |
| 3.0ft    | 0.91m | 41.3fc         | 2.0ft      | 0.61m | 0.4ft | 0.12m |
| 4.5ft    | 1.37m | 18.3fc         | 2.9ft      | 0.88m | 0.5ft | 0.15m |
| 6.0ft    | 1.83m | 10.3fc         | 3.9ft      | 1.18m | 0.7ft | 0.21m |
| 7.5ft    | 2.29m | 6.60fc         | 4.9ft      | 1.49m | 0.9ft | 0.27m |
| 9.0ft    | 2.74m | 4.59fc         | 5.9ft      | 1.79m | 1.1ft | 0.33m |

Delivered Lumen: 49 lm  
 ■ Vertical Beam Spread: 36.3°  
 ■ Horizontal Beam Spread: 6.8°

Polar Candela Distribution

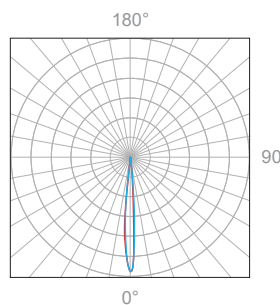

Beam Width: 8°



Illuminance at a Distance

| Distance |       | Center Beam fc | Beam Width |       |       |       |
|----------|-------|----------------|------------|-------|-------|-------|
| 1.5ft    | 0.46m | 1,015fc        | 0.2ft      | 0.06m | 0.2ft | 0.06m |
| 3.0ft    | 0.91m | 254fc          | 0.4ft      | 0.12m | 0.4ft | 0.12m |
| 4.5ft    | 1.37m | 113fc          | 0.7ft      | 0.21m | 0.6ft | 0.18m |
| 6.0ft    | 1.83m | 63.4fc         | 0.9ft      | 0.27m | 0.9ft | 0.27m |
| 7.5ft    | 2.29m | 40.6fc         | 1.1ft      | 0.33m | 1.1ft | 0.33m |
| 9.0ft    | 2.74m | 28.2fc         | 1.3ft      | 0.39m | 1.3ft | 0.39m |

Delivered Lumen: 61.3 lm  
 ■ Vertical Beam Spread: 8.5°  
 ■ Horizontal Beam Spread: 8.2°

2W, 3000K, 90+ CRI

**Polar Candela Distribution**

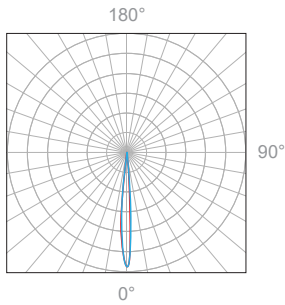

**Beam Width: 12°**



**Illuminance at a Distance**

| Distance |       | Center Beam fc | Beam Width |       |       |       |
|----------|-------|----------------|------------|-------|-------|-------|
| 1.5ft    | 0.46m | 774fc          | 0.3ft      | 0.09m | 0.3ft | 0.09m |
| 3.0ft    | 0.91m | 194fc          | 0.6ft      | 0.18m | 0.6ft | 0.18m |
| 4.5ft    | 1.37m | 86fc           | 0.9ft      | 0.27m | 0.9ft | 0.27m |
| 6.0ft    | 1.83m | 48.4fc         | 1.3ft      | 0.39m | 1.3ft | 0.39m |
| 7.5ft    | 2.29m | 31fc           | 1.6ft      | 0.48m | 1.6ft | 0.48m |
| 9.0ft    | 2.74m | 21.5fc         | 1.9ft      | 0.58m | 1.9ft | 0.58m |

Delivered Lumen: 116.8 lm  
 ■ Vertical Beam Spread: 12°  
 ■ Horizontal Beam Spread: 12°

**Polar Candela Distribution**

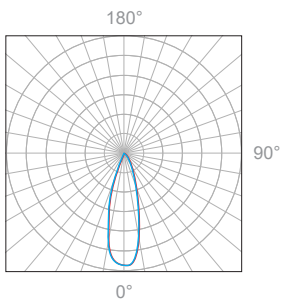

**Beam Width: 30°**



**Illuminance at a Distance**

| Distance |       | Center Beam fc | Beam Width |       |       |       |
|----------|-------|----------------|------------|-------|-------|-------|
| 1.5ft    | 0.46m | 152fc          | 0.8ft      | 0.24m | 0.8ft | 0.24m |
| 3.0ft    | 0.91m | 38fc           | 1.6ft      | 0.48m | 1.6ft | 0.48m |
| 4.5ft    | 1.37m | 16.9fc         | 2.4ft      | 0.73m | 2.4ft | 0.73m |
| 6.0ft    | 1.83m | 9.49fc         | 3.2ft      | 0.97m | 3.2ft | 0.97m |
| 7.5ft    | 2.29m | 6.07fc         | 4.0ft      | 1.22m | 4.0ft | 1.22m |
| 9.0ft    | 2.74m | 4.22fc         | 4.7ft      | 1.43m | 4.7ft | 1.43m |

Delivered Lumen: 121 lm  
 ■ Vertical Beam Spread: 29.5°  
 ■ Horizontal Beam Spread: 29.5°

**Polar Candela Distribution**

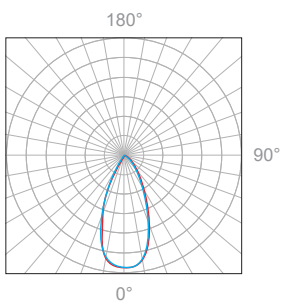

**Beam Width: 45°**

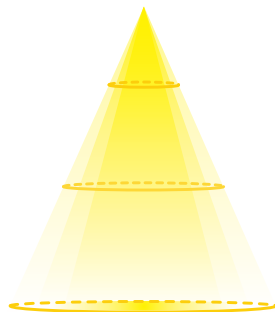

**Illuminance at a Distance**

| Distance |       | Center Beam fc | Beam Width |       |        |       |
|----------|-------|----------------|------------|-------|--------|-------|
| 3.0ft    | 0.91m | 21.8fc         | 2.6ft      | 0.79m | 2.6ft  | 0.79m |
| 6.0ft    | 1.83m | 5.45fc         | 5.2ft      | 1.58m | 5.1ft  | 1.55m |
| 9.0ft    | 2.74m | 2.42fc         | 7.7ft      | 2.34m | 7.7ft  | 2.34m |
| 12.0ft   | 3.65m | 1.36fc         | 10.3ft     | 3.13m | 10.2ft | 3.10m |
| 15.0ft   | 4.57m | 0.87fc         | 12.9ft     | 3.93m | 12.8ft | 3.90m |
| 18.0ft   | 5.48m | 0.61fc         | 15.5ft     | 4.72m | 15.3ft | 4.66m |

Delivered Lumen: 139.1 lm  
 ■ Vertical Beam Spread : 46.5°  
 ■ Horizontal Beam Spread : 46.1°

**Polar Candela Distribution**

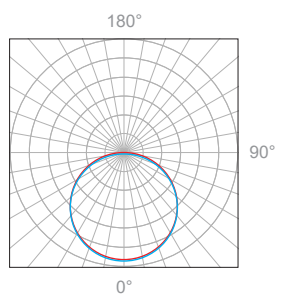

**Beam Width: 120°**

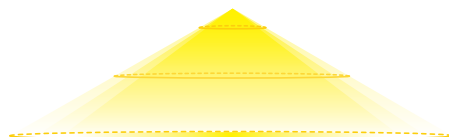

**Illuminance at a Distance**

| Distance |       | Center Beam fc | Beam Width |       |        |       |
|----------|-------|----------------|------------|-------|--------|-------|
| 1.5ft    | 0.46m | 21.3fc         | 4.1ft      | 1.25m | 4.1ft  | 1.25m |
| 3.0ft    | 0.91m | 5.33fc         | 8.1ft      | 2.46m | 8.1ft  | 2.46m |
| 4.5ft    | 1.37m | 2.37fc         | 12.2ft     | 3.71m | 12.2ft | 3.71m |
| 6.0ft    | 1.83m | 1.33fc         | 16.3ft     | 4.96m | 16.3ft | 4.96m |
| 7.5ft    | 2.29m | 0.85fc         | 20.3ft     | 6.18m | 20.3ft | 6.18m |
| 9.0ft    | 2.74m | 0.59fc         | 24.4ft     | 7.43m | 24.4ft | 7.43m |

Delivered Lumen: 119 lm  
 ■ Vertical Beam Spread : 107.1°  
 ■ Horizontal Beam Spread : 107.1°