

# L52

## INTERIOR

Millwork & Cabinet | For ceilings, counters & cabinets

● Dry location

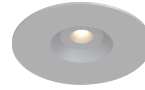

Shown with 120° with no accessories



Shown with 120° with **HS** (half shroud)  
\* Refer to Appendix for other shroud options.

### Ordering Information

Clear Form

Date : \_\_\_\_\_

Quantity : \_\_\_\_\_

Project : \_\_\_\_\_

Note : \_\_\_\_\_

Type : \_\_\_\_\_

### Specifications

Luminaire | Example Code: L52-F-2-W30H-W-NA-MA // L52-F-2-WD-W-NA-MA

Product	Mounting	Version	CCT & CRI <sup>1</sup>	Beam Angle	Shrouds/Accessories (optional) <sup>2</sup>	Finish <sup>3</sup>
<b>L52</b>	F friction fit spring clips	1 1W	<b>W22S</b> 2200K 80+	<b>S</b> spot 12°	<b>NA</b> no accessories	<b>Aluminum Finishes:</b> <b>MA</b> matte clear anodized <b>BA</b> black anodized <b>BZ</b> bronze <b>WH</b> white powder coat  <b>Other Material:</b> <b>ABZ</b> antique bronze
	C coil spring clips	2 2W	<b>W27H</b> 2700K 90+	<b>N</b> narrow flood 30°	<b>FS</b> full shroud	
			<b>W30H</b> 3000K 90+	<b>F</b> flood 45°	<b>HS</b> half shroud	
			<b>W35H</b> 3500K 90+	<b>W</b> wide flood 120°	<b>LBSH</b> long black shroud	
			<b>W41H</b> 4100K 90+			

Product	Mounting	Version	CCT & CRI <sup>1</sup>	Beam Angle	Shrouds/Accessories (optional) <sup>2</sup>	Finish <sup>3</sup>
<b>L52</b>			<b>WD</b>			<b>Aluminum Finishes:</b> <b>MA</b> matte clear anodized <b>BA</b> black anodized <b>BZ</b> bronze <b>WH</b> white powder coat  <b>Other Material:</b> <b>ABZ</b> antique bronze
	F friction fit spring clips	1 1W	<b>WD</b> warm dimming (2100-3000K, 95+ CRI) <sup>1</sup>	<b>F</b> flood 56°	<b>NA</b> no accessories	
	C coil spring clips	2 2W		<b>W</b> wide flood 83°	<b>FS</b> full shroud <b>HS</b> half shroud	

### System Components (Ordered Separately)

Remote Driver : \_\_\_\_\_

\* Consult MP Lighting Website or Factory.

### Important Notes

#### Specification

- Refer to pg.2 - for Light Quality & Colour Consistency details. WD option is powered by a remote 30W 300mA driver, for use with 1-5 fixtures and 0-10V dimming only.
- LBSH: only available in black finish
- Refer to Appendix or MP Lighting website for complete look of luminaire with different trim finish options. **ABZ**: only available with 120° beam angle and NA (no accessories).

#### Warranty Notes & Disclaimer

Malfunxion and damage to product due to incompatible dimming system or misuse will not be covered under warranty. Consult MP Lighting for recommended drivers. If the fixture has an option to be installed with a dimming control system, consult a dimming system manufacturer with minimum load before installing. MP Lighting reserves the right, at its sole discretion, at any time and without notice, to make design changes to any of our products. Consult MP Lighting website for most updated documentation.

# L52

## INTERIOR

Millwork & Cabinet | For ceilings, counters & cabinets

- Dry location

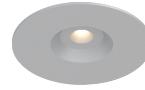

Shown with 120° with no accessories



Shown with 120° with **HS** (half shroud)  
\* Refer to Appendix for other shroud options.

### Performance

Wattage	Forward Current	Power Consumption Budget per fixture (including driver)	LED output (Source)	Fixture Output (Delivered)
1W	350mA	1.5W	110 lm	46-78 lm
2W	700mA	3.0W	220 lm	93-154 lm
1W (WD)	150mA	1.5W	110 lm	27-46 lm
2W (WD)	300mA	3.0W	220 lm	65-145 lm

### Application

Environment	Dry Location approved. IP 40.
Mounting	<p><b>F:</b> Recessed mount to cabinet millwork with friction fit spring clip</p> <p><b>C:</b> Recessed mount with coil spring clip. Mounts directly to cabinet millwork or mounts to standard 4" octagonal back box (supplied by others) using MP Lighting cover plate (PLT-CS-01, ordered separately) in drywall applications.</p> <p><b>Cut-out size:</b> Ø1-1/2" (38mm)</p>

### Electrical

Electrical	Remote LED drivers (120-277V AC input, <b>constant current output</b> ): Fixtures to be wired in series. WD option powered by a remote 30 Watt 300mA driver. For use with 1 to 5 fixtures. 0-10V dimming only.
Control	<p><b>On/off control</b></p> <p><b>Dimming:</b> ELV or 0-10V dimming with appropriate drivers</p> <p><b>Other options (consult factory):</b> TRIAC/MLV, DMX, DALI, Casambi, Power over Ethernet</p>

### Luminaire Construction

LED Light Source	<p><b>W22S</b> = CCT: 2200K, CRI (Ra): 80+, Colour Consistency: 3SDCM</p> <p><b>W27H</b> = CCT: 2700K, CRI (Ra): 90+, Colour Consistency: 2SDCM</p> <p><b>W30H</b> = CCT: 3000K, CRI (Ra): 90+, Colour Consistency: 2SDCM</p> <p><b>W35H</b> = CCT: 3500K, CRI (Ra): 90+, Colour Consistency: 2SDCM</p> <p><b>W41H</b> = CCT: 4100K, CRI (Ra): 90+, Colour Consistency: 3SDCM</p> <p><b>WD</b> = CCT: 1800K-3000K, CRI (Ra): 95+</p>
Standard Compliance	✓ADA-compliant ✓WELL standard – Feature 58: Color Quality
Material	<b>Fixture:</b> machined marine-grade aluminum or antique bronze
Supplied with	<b>Standard installation:</b> Comes with friction fit spring clip or coil spring clip, and 2'(610mm) wire lead.
Warranty & LED Life	5 years limited warranty Estimated useful life of LED is 50,000 hours.

### Ordered Separately

System Components	<p><b>Power supplies:</b> remote driver</p> <p>Please consult factory or visit <a href="#">Recommended Drivers</a> for available driver options.</p> <p><b>Mounting Plate for Coil Spring Clip (PLT-CS-01):</b> Refer to pg.4- Mounting Plate for Installation with standard 4" octagonal back box (supplied by others) in drywall applications.</p>
-------------------	------------------------------------------------------------------------------------------------------------------------------------------------------------------------------------------------------------------------------------------------------------------------------------------------------------------------------------------------------

Mounting Options & Dimensions

LED Fixture Dimensions | Shown with F (friction fit spring clip) & 120° with NA (no accessories)

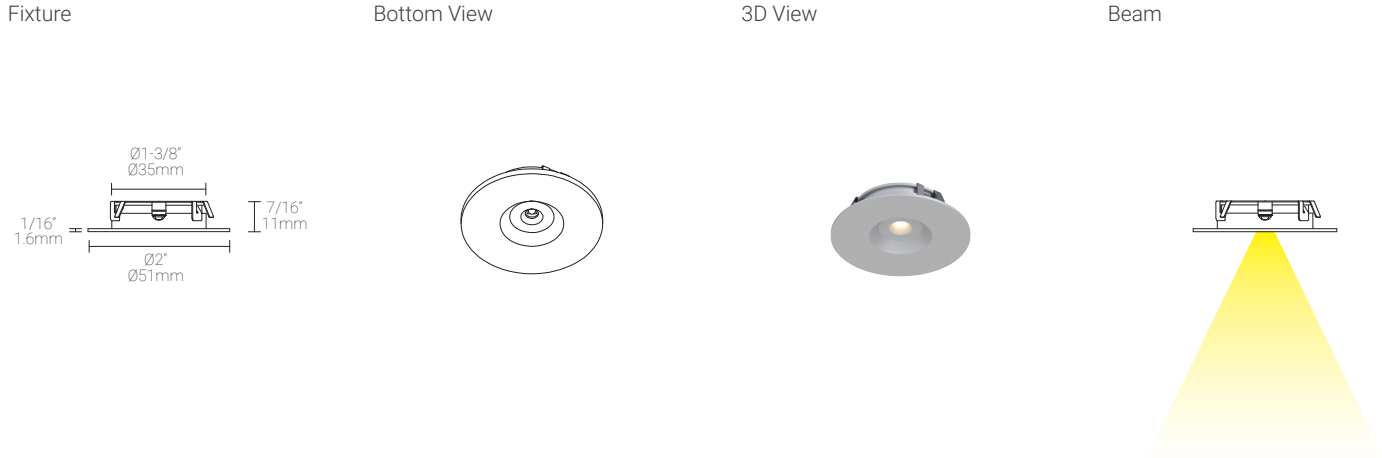

LED Fixture Dimensions | Shown with C (coil spring clip) & 120° with NA (no accessories)

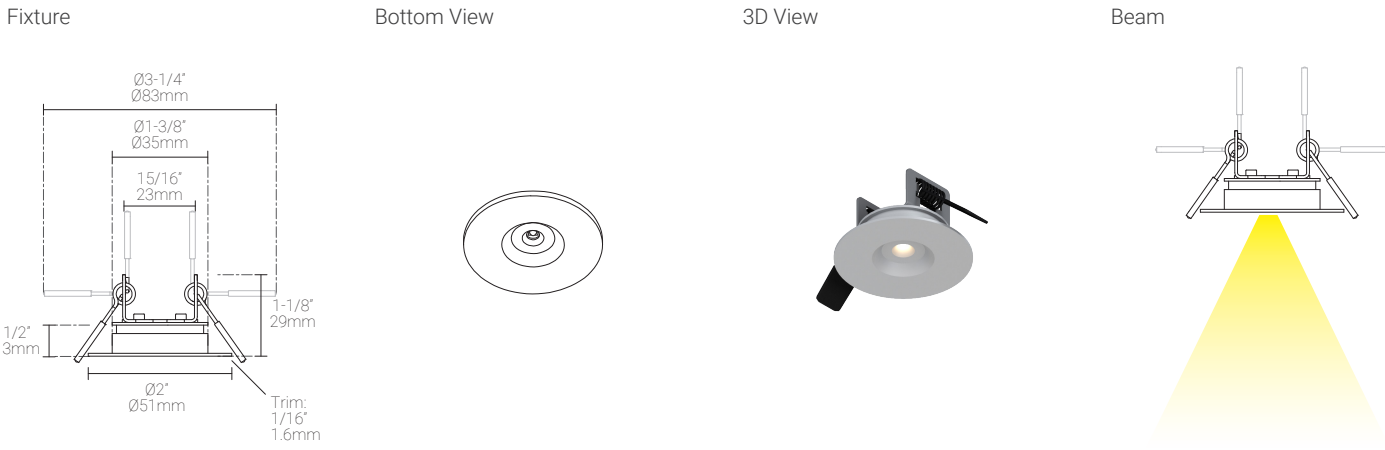

Shroud Options and Dimensions | Shown with F (friction fit spring clip)

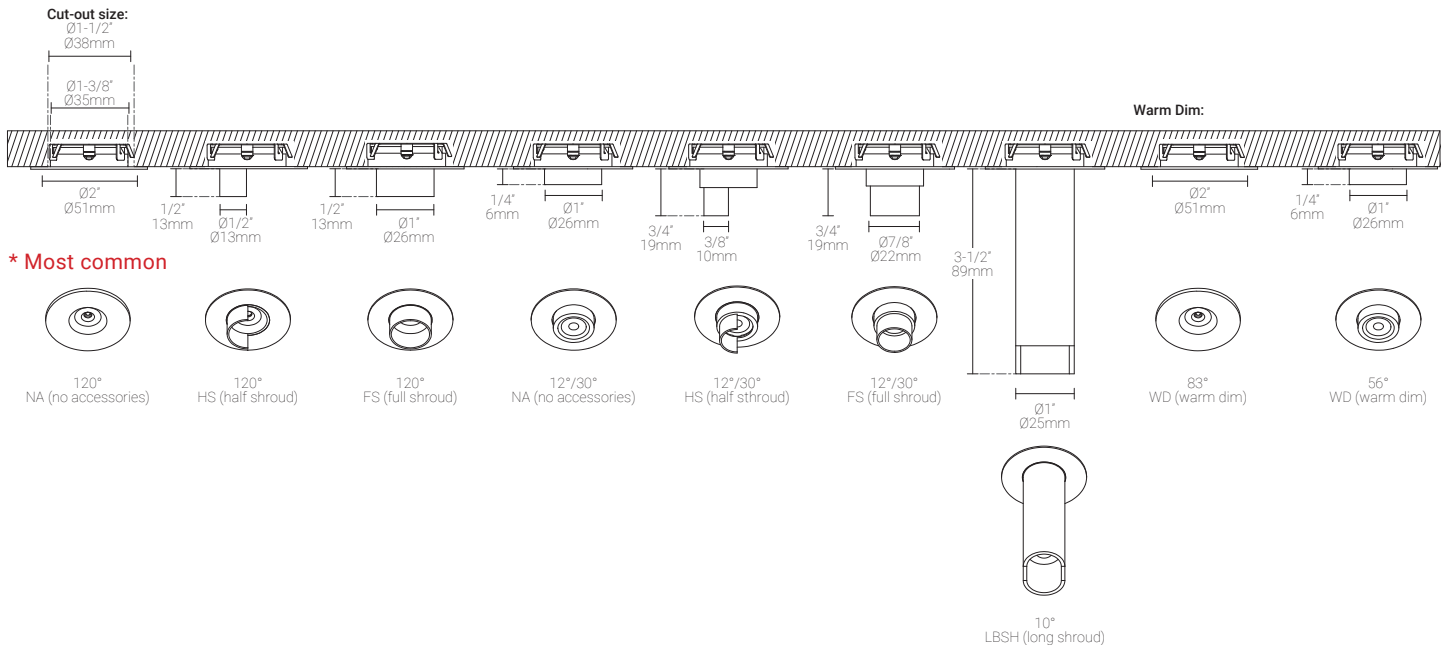

Mounting Options & Dimensions

Recessed mount Installation | Shown with F (friction fit spring clip) & 120° with NA (no accessories)

Fixture

Push LED housing with friction fit spring clip into  $\varnothing 1\text{-}1/2"$  ( $\varnothing 38\text{mm}$ ) hole until flush with surface.

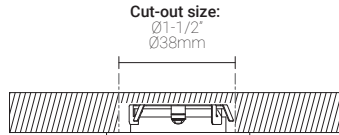
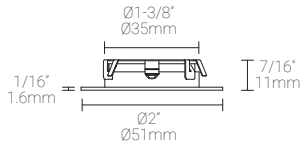

Recessed mount Installation | Shown with C (coil spring clip) & 120° with NA (no accessories)

Fixture

Push LED housing with coil spring clip into  $\varnothing 1\text{-}1/2"$  ( $\varnothing 38\text{mm}$ ) hole until flush with surface.

**PLT-CS-01 (ordered separately):** Mounting plate for C, coil spring clip. Compatible with  $4\text{-}11/16"$  square back box (supplied by others, suggested: Ilberville BC72171-K). Recommended for drywall applications.

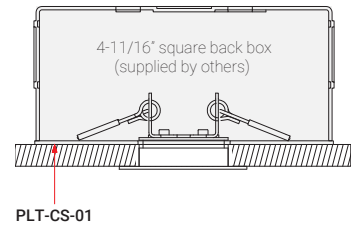
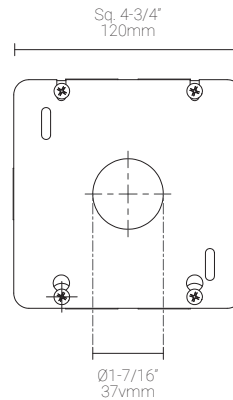
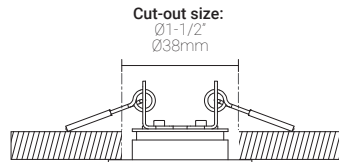
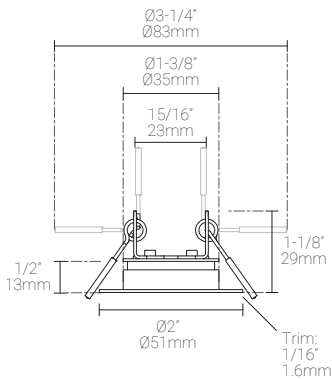

1W, 3000K, 90+ CRI, 120°

**Polar Candela Distribution With NA (no accessories)**

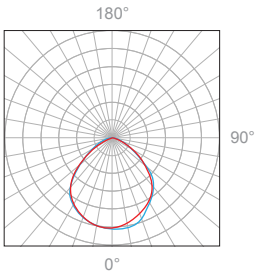

**Beam width shown with NA (no accessories)**

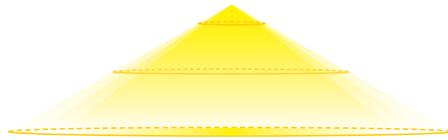

**Illuminance at a Distance**

Distance		Center Beam fc	Beam Width			
1.0ft	0.30m	44fc	2.3ft	0.70m	2.3ft	0.70m
2.0ft	0.61m	11fc	4.6ft	1.40m	4.5ft	1.37m
3.0ft	0.91m	4.8fc	6.9ft	2.10m	6.8ft	2.07m
4.0ft	1.22m	2.7fc	9.3ft	2.83m	9.0ft	2.74m
5.0ft	1.52m	1.8fc	11.6ft	3.54m	11.3ft	3.44m
6.0ft	1.83m	1.3fc	13.9ft	4.24m	13.5ft	4.11m

Delivered Lumen: 55.9 lm  
 ■ Vertical Beam Spread: 98.4°  
 ■ Horizontal Beam Spread: 96.9°

**Polar Candela Distribution With HS (half shroud)**

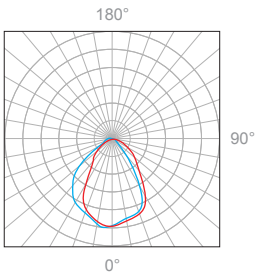

**Beam width shown with HS (half shroud)**

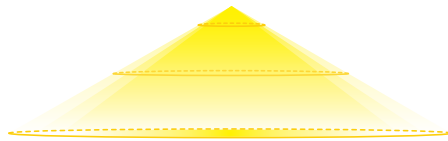

**Illuminance at a Distance**

Distance		Center Beam fc	Beam Width			
1.0ft	0.30m	43fc	1.8ft	0.55m	1.6ft	0.49m
2.0ft	0.61m	10fc	3.5ft	1.07m	3.2ft	0.98m
3.0ft	0.91m	4.4fc	5.3ft	1.62m	4.8ft	1.46m
4.0ft	1.22m	2.5fc	7.1ft	2.16m	6.4ft	1.95m
5.0ft	1.52m	1.6fc	8.8ft	2.68m	7.9ft	2.41m
6.0ft	1.83m	1.1fc	10.6ft	3.23m	9.5ft	2.90m

Delivered Lumen: 60.4 lm  
 ■ Vertical Beam Spread: 82.9°  
 ■ Horizontal Beam Spread: 76.9°

**Polar Candela Distribution With FS (full shroud)**

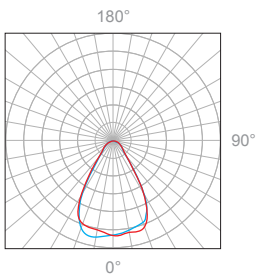

**Beam width shown with FS (full shroud)**

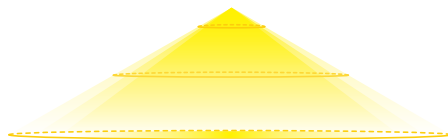

**Illuminance at a Distance**

Distance		Center Beam fc	Beam Width			
3.0ft	0.91m	50.8fc	1.3ft	0.40m	1.2ft	0.37m
6.0ft	1.83m	12.7fc	2.6ft	0.79m	2.4ft	0.73m
9.0ft	2.74m	5.64fc	3.9ft	1.19m	3.6ft	1.10m
12.0ft	3.66m	3.17fc	5.1ft	1.55m	4.7ft	1.43m
15.0ft	4.57m	2.03fc	6.4ft	1.95m	5.9ft	1.80m
18.0ft	5.49m	1.41fc	7.7ft	2.35m	7.1ft	2.16m

Delivered Lumen: 46.7 lm  
 ■ Vertical Beam Spread: 65.5°  
 ■ Horizontal Beam Spread: 61.3°

1W, 3000K, 90+ CRI, 45°

**Polar Candela Distribution With NA (no accessories)**

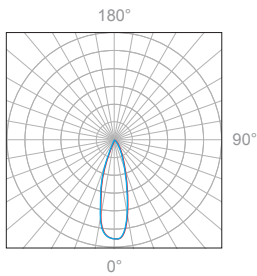

**Beam width shown with NA (no accessories)**

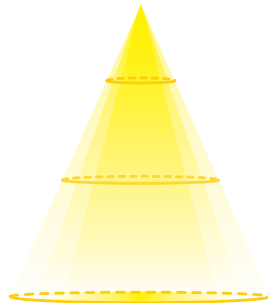

**Illuminance at a Distance**

Distance		Center Beam fc	Beam Width			
1.0ft	0.30m	129fc	0.9ft	0.27m	0.9ft	0.27m
2.0ft	0.61m	32.2fc	1.7ft	0.51m	1.7ft	0.51m
3.0ft	0.91m	14.3fc	2.6ft	0.79m	2.6ft	0.79m
4.0ft	1.22m	8.04fc	3.5ft	1.06m	3.5ft	1.06m
5.0ft	1.52m	5.15fc	4.3ft	1.31m	4.4ft	1.34m
6.0ft	1.83m	3.57fc	5.2ft	1.58m	5.2ft	1.58m

Delivered Lumen: 89 lm  
 ■ Vertical Beam Spread: 47.0°  
 ■ Horizontal Beam Spread: 47.3°

**Polar Candela Distribution With HS (half shroud)**

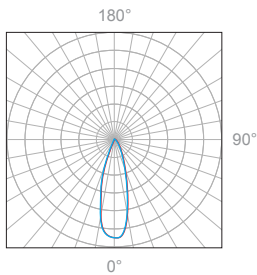

**Beam width shown with HS (half shroud)**

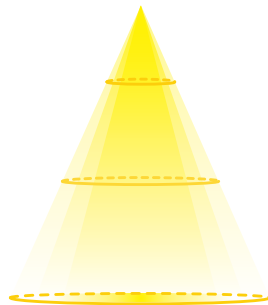

**Illuminance at a Distance**

Distance		Center Beam fc	Beam Width			
1.0ft	0.30m	127fc	0.8ft	0.24m	0.8ft	0.24m
2.0ft	0.61m	31.8fc	1.7ft	0.51m	1.7ft	0.51m
3.0ft	0.91m	14.1fc	2.5ft	0.76m	2.5ft	0.76m
4.0ft	1.22m	7.94fc	3.3ft	1.00m	3.4ft	1.03m
5.0ft	1.52m	5.08fc	4.1ft	1.25m	4.2ft	1.28m
6.0ft	1.83m	3.53fc	5.0ft	1.52m	5.1ft	1.55m

Delivered Lumen: 84.5 lm  
 ■ Vertical Beam Spread: 44.9°  
 ■ Horizontal Beam Spread: 45.7°

**Polar Candela Distribution With FS (full shroud)**

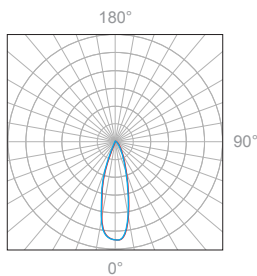

**Beam width shown with FS (full shroud)**

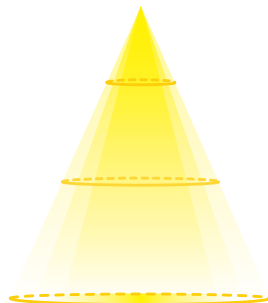

**Illuminance at a Distance**

Distance		Center Beam fc	Beam Width			
1.0ft	0.30m	127fc	0.8ft	0.24m	0.8ft	0.24m
2.0ft	0.61m	31.8fc	1.5ft	0.45m	1.6ft	0.48m
3.0ft	0.91m	14.1fc	2.3ft	0.70m	2.4ft	0.73m
4.0ft	1.22m	7.94fc	3.1ft	0.94m	3.1ft	0.94m
5.0ft	1.52m	5.08fc	3.8ft	1.15m	3.9ft	1.18m
6.0ft	1.83m	3.53fc	4.6ft	1.40m	4.7ft	1.43m

Delivered Lumen: 76.2 lm  
 ■ Vertical Beam Spread: 42.0°  
 ■ Horizontal Beam Spread: 42.9°

1W, 3000K, 90+ CRI, 30°

**Polar Candela Distribution With NA (no accessories)**

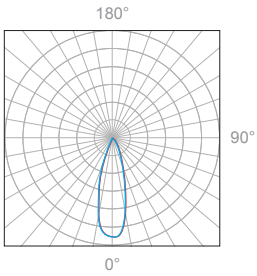

**Beam width shown with NA (no accessories)**

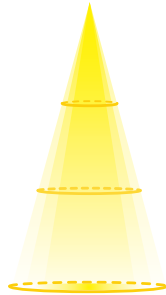

**Illuminance at a Distance**

Distance		Center Beam fc	Beam Width			
1.0ft	0.30m	415fc	0.5ft	0.15m	0.5ft	0.15m
2.0ft	0.61m	93fc	1.0ft	0.30m	1.0ft	0.30m
3.0ft	0.91m	38fc	1.5ft	0.46m	1.5ft	0.46m
4.0ft	1.22m	21fc	2.0ft	0.61m	2.0ft	0.61m
5.0ft	1.52m	14fc	2.5ft	0.76m	2.5ft	0.76m
6.0ft	1.83m	9.7fc	3.0ft	0.91m	3.0ft	0.91m

Delivered Lumen: 78 lm  
 ■ Vertical Beam Spread: 28.5°  
 ■ Horizontal Beam Spread: 28.6°

**Polar Candela Distribution With HS (half shroud)**

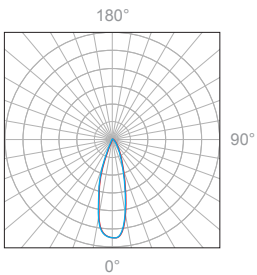

**Beam width shown with HS (half shroud)**

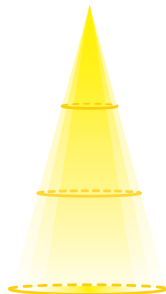

**Illuminance at a Distance**

Distance		Center Beam fc	Beam Width			
1.0ft	0.30m	484fc	0.5ft	0.15m	0.5ft	0.15m
2.0ft	0.61m	117fc	1.0ft	0.30m	1.0ft	0.30m
3.0ft	0.91m	49fc	1.5ft	0.46m	1.5ft	0.46m
4.0ft	1.22m	27fc	2.0ft	0.61m	2.0ft	0.61m
5.0ft	1.52m	17fc	2.5ft	0.76m	2.5ft	0.76m
6.0ft	1.83m	12fc	3.0ft	0.91m	3.0ft	0.91m

Delivered Lumen: 77.4 lm  
 ■ Vertical Beam Spread: 28.5°  
 ■ Horizontal Beam Spread: 28.6°

**Polar Candela Distribution With FS (full shroud)**

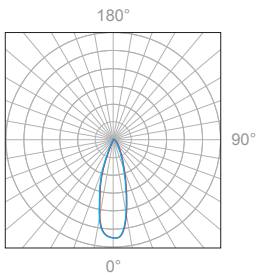

**Beam width shown with FS (full shroud)**

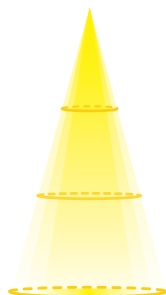

**Illuminance at a Distance**

Distance		Center Beam fc	Beam Width			
1.0ft	0.30m	468fc	0.5ft	0.15m	0.5ft	0.15m
2.0ft	0.61m	106fc	1.0ft	0.30m	1.0ft	0.30m
3.0ft	0.91m	43fc	1.5ft	0.46m	1.5ft	0.46m
4.0ft	1.22m	24fc	2.0ft	0.61m	2.0ft	0.61m
5.0ft	1.52m	15fc	2.5ft	0.76m	2.5ft	0.76m
6.0ft	1.83m	10fc	3.0ft	0.91m	3.0ft	0.91m

Delivered Lumen: 75 lm  
 ■ Vertical Beam Spread: 28.5°  
 ■ Horizontal Beam Spread: 28.6°

1W, 3000K, 90+ CRI, 12°

**Polar Candela Distribution With NA (no accessories)**

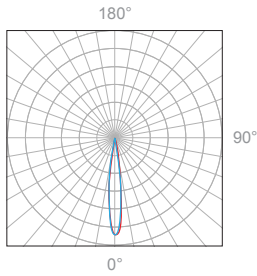

**Beam width shown with NA (no accessories)**



**Illuminance at a Distance**

Distance		Center Beam fc	Beam Width			
1.0ft	0.30m	451fc	0.3ft	0.09m	0.3ft	0.09m
2.0ft	0.61m	113fc	0.7ft	0.21m	0.7ft	0.21m
3.0ft	0.91m	50.1fc	1.0ft	0.30m	1.0ft	0.30m
4.0ft	1.22m	28.2fc	1.4ft	0.43m	1.4ft	0.43m
5.0ft	1.52m	18.1fc	1.7ft	0.52m	1.7ft	0.52m
6.0ft	1.83m	12.5fc	2.0ft	0.61m	2.0ft	0.61m

Delivered Lumen: 71.8 lm  
 ■ Vertical Beam Spread: 19.4°  
 ■ Horizontal Beam Spread: 19.4°

**Polar Candela Distribution With HS (half shroud)**

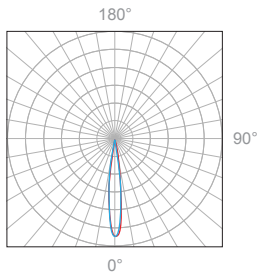

**Beam width shown with HS (half shroud)**



**Illuminance at a Distance**

Distance		Center Beam fc	Beam Width			
1.0ft	0.30m	399fc	0.4ft	0.12m	0.4ft	0.12m
2.0ft	0.61m	99.8fc	0.7ft	0.21m	0.7ft	0.21m
3.0ft	0.91m	44.4fc	1.1ft	0.33m	1.1ft	0.33m
4.0ft	1.22m	25.0fc	1.5ft	0.46m	1.4ft	0.43m
5.0ft	1.52m	16.0fc	1.8ft	0.55m	1.8ft	0.55m
6.0ft	1.83m	11.1fc	2.2ft	0.67m	2.1ft	0.64m

Delivered Lumen: 67.9 lm  
 ■ Vertical Beam Spread: 20.7°  
 ■ Horizontal Beam Spread: 20.1°

**Polar Candela Distribution With FS (full shroud)**

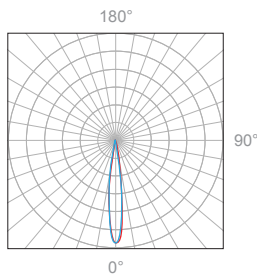

**Beam width shown with FS (full shroud)**



**Illuminance at a Distance**

Distance		Center Beam fc	Beam Width			
1.0ft	0.30m	453fc	0.3ft	0.09m	0.3ft	0.09m
2.0ft	0.61m	113fc	0.7ft	0.21m	0.7ft	0.21m
3.0ft	0.91m	50.3fc	1.0ft	0.30m	1.0ft	0.30m
4.0ft	1.22m	28.3fc	1.4ft	0.43m	1.4ft	0.43m
5.0ft	1.52m	18.1fc	1.7ft	0.52m	1.7ft	0.52m
6.0ft	1.83m	12.6fc	2.0ft	0.61m	2.0ft	0.61m

Delivered Lumen: 65 lm  
 ■ Vertical Beam Spread: 19.4°  
 ■ Horizontal Beam Spread: 19.4°



2W, 3000K, 90+ CRI, 120°

**Polar Candela Distribution With NA (no accessories)**

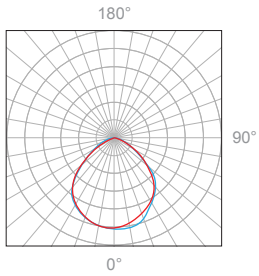

**Beam width shown with NA (no accessories)**

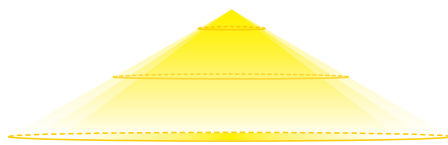

**Illuminance at a Distance**

Distance		Center Beam fc	Beam Width			
1.0ft	0.30m	87fc	1.9ft	0.58m	1.9ft	0.58m
2.0ft	0.61m	21fc	3.8ft	1.16m	3.8ft	1.16m
3.0ft	0.91m	9fc	5.7ft	1.74m	5.7ft	1.74m
4.0ft	1.22m	5.1fc	7.6ft	2.32m	7.6ft	2.32m
5.0ft	1.52m	3.3fc	9.4ft	2.87m	9.4ft	2.87m
6.0ft	1.83m	2.3fc	11.3ft	3.44m	11.3ft	3.44m

Delivered Lumen: 110.1 lm  
 ■ Vertical Beam Spread: 98.8°  
 ■ Horizontal Beam Spread: 97.1°

**Polar Candela Distribution With HS (half shroud)**

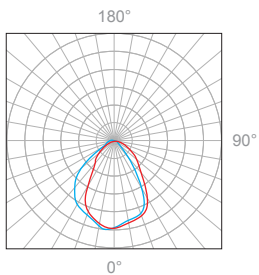

**Beam width shown with HS (half shroud)**

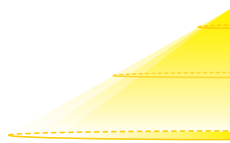

**Illuminance at a Distance**

Distance		Center Beam fc	Beam Width			
1.0ft	0.30m	77fc	1.8ft	0.55m	2.3ft	0.70m
2.0ft	0.61m	19fc	3.5ft	1.07m	4.7ft	1.43m
3.0ft	0.91m	8.2fc	5.3ft	1.62m	7.0ft	2.13m
4.0ft	1.22m	4.7fc	7.1ft	2.16m	9.3ft	2.83m
5.0ft	1.52m	2.9fc	8.8ft	2.68m	11.7ft	3.57m
6.0ft	1.83m	2.1fc	10.6ft	3.23m	14.0ft	4.27m

Delivered Lumen: 120.4 lm  
 ■ Vertical Beam Spread: 82.6°  
 ■ Horizontal Beam Spread: 87.5°

**Polar Candela Distribution With FS (full shroud)**

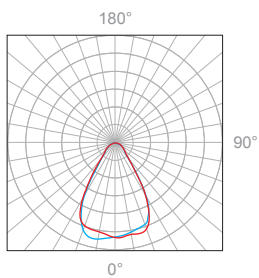

**Beam width shown with FS (full shroud)**

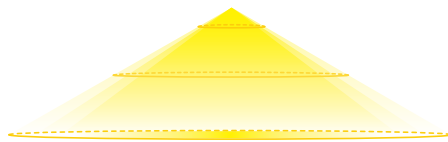

**Illuminance at a Distance**

Distance		Center Beam fc	Beam Width			
1.0ft	0.30m	77fc	1.4ft	0.43m	1.7ft	0.37m
2.0ft	0.61m	18fc	2.8ft	0.85m	3.3ft	1.01m
3.0ft	0.91m	7.9fc	4.2ft	1.28m	5.0ft	1.52m
4.0ft	1.22m	4.5fc	5.6ft	1.71m	6.6ft	2.01m
5.0ft	1.52m	2.8fc	7.0ft	2.13m	8.3ft	2.53m
6.0ft	1.83m	2fc	8.4ft	2.56m	9.9ft	3.02m

Delivered Lumen: 93.1 lm  
 ■ Vertical Beam Spread: 65.2°  
 ■ Horizontal Beam Spread: 61.1°

2W, 3000K, 90+ CRI, 45°

**Polar Candela Distribution With NA (no accessories)**

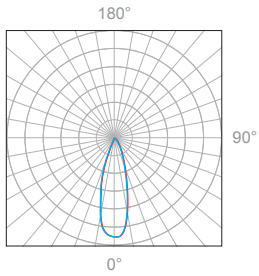

**Beam width shown with NA (no accessories)**

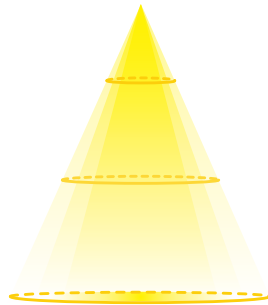

**Illuminance at a Distance**

Distance		Center Beam fc	Beam Width			
1.0ft	0.30m	228fc	0.9ft	0.27m	0.9ft	0.27m
2.0ft	0.61m	57.1fc	1.7ft	0.51m	1.7ft	0.51m
3.0ft	0.91m	25.4fc	2.6ft	0.79m	2.6ft	0.79m
4.0ft	1.22m	14.3fc	3.5ft	1.06m	3.5ft	1.06m
5.0ft	1.52m	9.13fc	4.4ft	1.34m	4.4ft	1.34m
6.0ft	1.83m	6.34fc	5.2ft	1.58m	5.2ft	1.58m

Delivered Lumen: 157.8 lm  
 ■ Vertical Beam Spread: 47.0°  
 ■ Horizontal Beam Spread: 47.2°

**Polar Candela Distribution With HS (half shroud)**

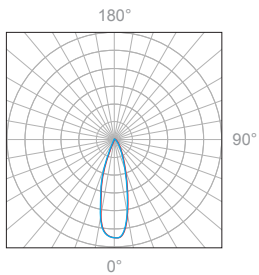

**Beam width shown with HS (half shroud)**

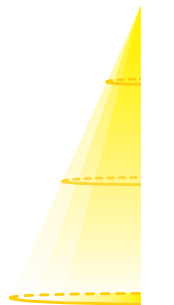

**Illuminance at a Distance**

Distance		Center Beam fc	Beam Width			
1.0ft	0.30m	225fc	0.8ft	0.24m	0.8ft	0.24m
2.0ft	0.61m	56.3fc	1.7ft	0.51m	1.7ft	0.51m
3.0ft	0.91m	25.0fc	2.5ft	0.76m	2.5ft	0.76m
4.0ft	1.22m	14.1fc	3.4ft	1.03m	3.4ft	1.03m
5.0ft	1.52m	9.00fc	4.2ft	1.28m	4.2ft	1.28m
6.0ft	1.83m	6.25fc	5.0ft	1.52m	5.1ft	1.55m

Delivered Lumen: 150.4 lm  
 ■ Vertical Beam Spread: 45.5°  
 ■ Horizontal Beam Spread: 46.0°

**Polar Candela Distribution With FS (full shroud)**

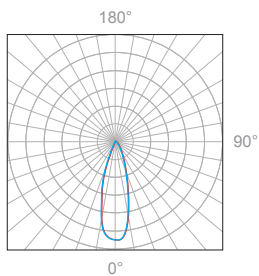

**Beam width shown with FS (full shroud)**

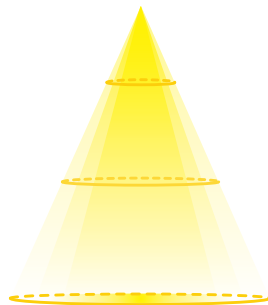

**Illuminance at a Distance**

Distance		Center Beam fc	Beam Width			
1.0ft	0.30m	223fc	0.8ft	0.24m	0.8ft	0.24m
2.0ft	0.61m	55.9fc	1.6ft	0.48m	1.6ft	0.48m
3.0ft	0.91m	24.8fc	2.3ft	0.70m	2.4ft	0.73m
4.0ft	1.22m	14.0fc	3.1ft	0.94m	3.2ft	0.97m
5.0ft	1.52m	8.94fc	3.89t	1.18m	4.0ft	1.21m
6.0ft	1.83m	6.21fc	4.7ft	1.43m	4.7ft	1.43m

Delivered Lumen: 135.1 lm  
 ■ Vertical Beam Spread: 42.7°  
 ■ Horizontal Beam Spread: 43.2°

2W, 3000K, 90+ CRI, 30°

**Polar Candela Distribution With NA (no accessories)**

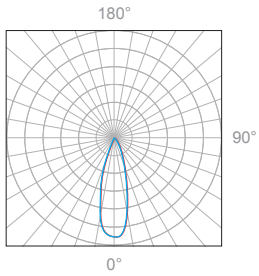

**Beam width shown with NA (no accessories)**



**Illuminance at a Distance**

Distance		Center Beam fc	Beam Width			
1.0ft	0.30m	610fc	0.4ft	0.12m	0.4ft	0.12m
2.0ft	0.61m	155fc	0.8ft	0.24m	0.8ft	0.24m
3.0ft	0.91m	67fc	1.2ft	0.37m	1.2ft	0.37m
4.0ft	1.22m	37fc	1.5ft	0.46m	1.5ft	0.46m
5.0ft	1.52m	23fc	1.9ft	0.58m	1.9ft	0.58m
6.0ft	1.83m	16fc	2.3ft	0.70m	2.3ft	0.70m

Delivered Lumen: 143 lm  
 ■ Vertical Beam Spread: 28.4°  
 ■ Horizontal Beam Spread: 28.5°

**Polar Candela Distribution With HS (half shroud)**

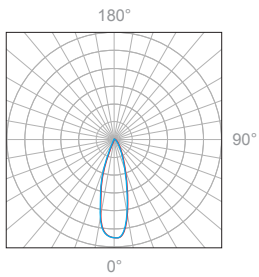

**Beam width shown with HS (half shroud)**



**Illuminance at a Distance**

Distance		Center Beam fc	Beam Width			
1.0ft	0.30m	901fc	0.4ft	0.12m	0.4ft	0.12m
2.0ft	0.61m	215fc	0.8ft	0.24m	0.8ft	0.24m
3.0ft	0.91m	89fc	1.1ft	0.34m	1.1ft	0.34m
4.0ft	1.22m	47fc	1.5ft	0.46m	1.5ft	0.46m
5.0ft	1.52m	31fc	1.9ft	0.58m	1.9ft	0.58m
6.0ft	1.83m	22fc	2.3ft	0.70m	2.3ft	0.70m

Delivered Lumen: 153 lm  
 ■ Vertical Beam Spread: 28.4°  
 ■ Horizontal Beam Spread: 28.5°

**Polar Candela Distribution With FS (full shroud)**

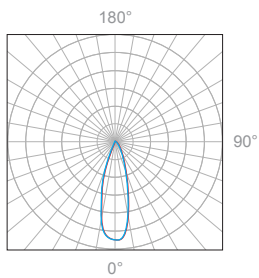

**Beam width shown with FS (full shroud)**

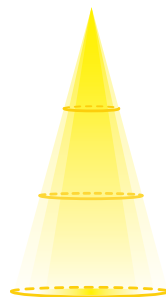

**Illuminance at a Distance**

Distance		Center Beam fc	Beam Width			
1.0ft	0.30m	881fc	0.4ft	0.12m	0.4ft	0.12m
2.0ft	0.61m	206fc	0.8ft	0.24m	0.8ft	0.24m
3.0ft	0.91m	89fc	1.2ft	0.37m	1.2ft	0.37m
4.0ft	1.22m	47fc	1.6ft	0.49m	1.6ft	0.49m
5.0ft	1.52m	31fc	2.0ft	0.61m	2.0ft	0.61m
6.0ft	1.83m	20fc	2.4ft	0.73m	2.4ft	0.73m

Delivered Lumen: 149 lm  
 ■ Vertical Beam Spread: 28.3°  
 ■ Horizontal Beam Spread: 28.3°

2W, 3000K, 90+ CRI, 12°

**Polar Candela Distribution With NA (no accessories)**

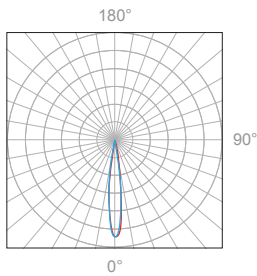

**Beam width shown with NA (no accessories)**



**Illuminance at a Distance**

Distance		Center Beam fc	Beam Width			
1.0ft	0.30m	1230fc	0.2ft	0.06m	0.3ft	0.09m
2.0ft	0.61m	319fc	0.5ft	0.15m	0.7ft	0.21m
3.0ft	0.91m	137fc	0.7ft	0.21m	1.0ft	0.30m
4.0ft	1.22m	74fc	0.9ft	0.27m	1.4ft	0.43m
5.0ft	1.52m	48fc	1.2ft	0.36m	1.7ft	0.52m
6.0ft	1.83m	33fc	1.4ft	0.43m	2.0ft	0.61m

Delivered Lumen: 143 lm  
 ■ Vertical Beam Spread: 19.4°  
 ■ Horizontal Beam Spread: 19.4°

**Polar Candela Distribution With HS (half shroud)**

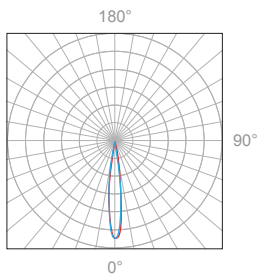

**Beam width shown with HS (half shroud)**



**Illuminance at a Distance**

Distance		Center Beam fc	Beam Width			
1.0ft	0.30m	1252fc	0.3ft	0.09m	0.3ft	0.09m
2.0ft	0.61m	307fc	0.5ft	0.15m	0.5ft	0.15m
3.0ft	0.91m	127fc	0.8ft	0.24m	0.8ft	0.24m
4.0ft	1.22m	70fc	1.0ft	0.30m	1.0ft	0.30m
5.0ft	1.52m	44fc	1.3ft	0.40m	1.3ft	0.40m
6.0ft	1.83m	30fc	1.6ft	0.49m	1.6ft	0.49m

Delivered Lumen: 135 lm  
 ■ Vertical Beam Spread: 20.2°  
 ■ Horizontal Beam Spread: 20.2°

**Polar Candela Distribution With FS (full shroud)**

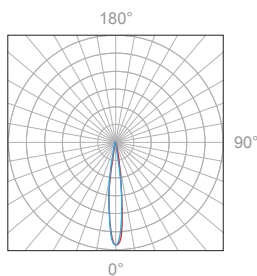

**Beam width shown with FS (full shroud)**



**Illuminance at a Distance**

Distance		Center Beam fc	Beam Width			
1.0ft	0.30m	1080fc	0.2ft	0.06m	0.2ft	0.06m
2.0ft	0.61m	263fc	0.5ft	0.15m	0.5ft	0.15m
3.0ft	0.91m	112fc	0.7ft	0.21m	0.7ft	0.21m
4.0ft	1.22m	63fc	0.9ft	0.27m	0.9ft	0.27m
5.0ft	1.52m	41fc	1.2ft	0.37m	1.2ft	0.37m
6.0ft	1.83m	27fc	1.4ft	0.43m	1.4ft	0.43m

Delivered Lumen: 65 lm  
 ■ Vertical Beam Spread: 19°  
 ■ Horizontal Beam Spread: 19°

**Polar Candela Distribution LBSH (Long Black Shroud)**

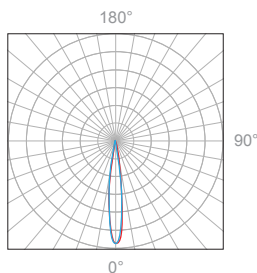

**Beam width shown with LBSH (Long Black Shroud)**



**Illuminance at a Distance**

Distance		Center Beam fc	Beam Width			
1.0ft	0.30m	75.7fc	0.2ft	0.06m	0.2ft	0.06m
2.0ft	0.61m	18.9fc	0.3ft	0.09m	0.3ft	0.09m
3.0ft	0.91m	8.41fc	0.5ft	0.15m	0.5ft	0.15m
4.0ft	1.22m	4.73fc	0.6ft	0.18m	0.6ft	0.18m
5.0ft	1.52m	3.03fc	0.8ft	0.24m	0.8ft	0.24m
6.0ft	1.83m	2.10fc	0.9ft	0.27m	0.9ft	0.27m

Delivered Lumen: 6.7 lm  
 ■ Vertical Beam Spread: 9°  
 ■ Horizontal Beam Spread: 9°

1W, Warm Dimming, 56°

Polar Candela Distribution With NA (no accessories)

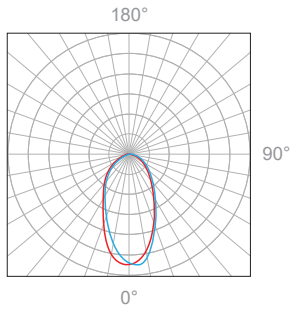

Beam width shown with NA (no accessories)

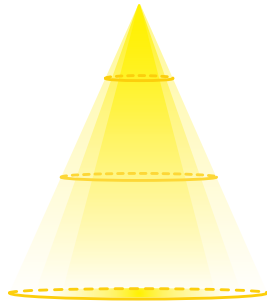

Illuminance at a Distance

Distance		Center Beam fc	Beam Width			
3.0ft	0.91m	3.57fc	3.2ft	0.97m	3.1ft	0.94m
6.0ft	1.83m	0.89fc	6.3ft	1.92m	6.2ft	1.89m
9.0ft	2.74m	0.40fc	9.5ft	2.89m	9.4ft	2.86m
12.0ft	3.65m	0.22fc	12.7ft	3.87m	12.5ft	3.81m
15.0ft	4.57m	0.14fc	15.9ft	4.84m	15.6ft	4.75m
18.0ft	5.48m	0.10fc	19.0ft	5.79m	18.7ft	5.70m

Delivered Lumen: 45.7 lm  
 ■ Vertical Beam Spread: 55.8°  
 ■ Horizontal Beam Spread: 54.9°

Polar Candela Distribution With HS (half shroud)

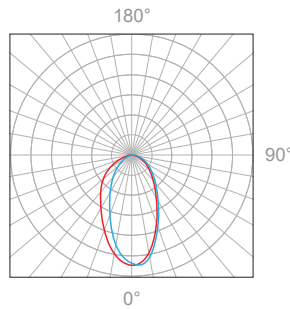

Beam width shown with HS (half shroud)

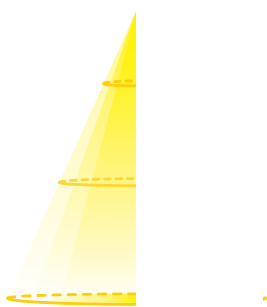

Illuminance at a Distance

Distance		Center Beam fc	Beam Width			
3.0ft	0.91m	3.57fc	3.0ft	0.91m	3.2ft	0.97m
6.0ft	1.83m	0.89fc	5.9ft	1.79m	6.3ft	1.92m
9.0ft	2.74m	0.40fc	8.9ft	2.71m	9.5ft	2.89m
12.0ft	3.65m	0.22fc	11.8ft	3.59m	12.7ft	3.87m
15.0ft	4.57m	0.14fc	14.8ft	4.51m	15.9ft	4.84m
18.0ft	5.48m	0.10fc	17.7ft	5.39m	19.0ft	5.79m

Delivered Lumen: 38.6 lm  
 ■ Vertical Beam Spread: 52.4°  
 ■ Horizontal Beam Spread: 55.7°

Polar Candela Distribution With FS (full shroud)

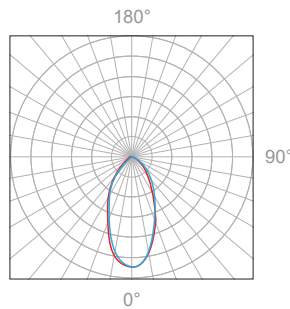

Beam width shown with FS (full shroud)

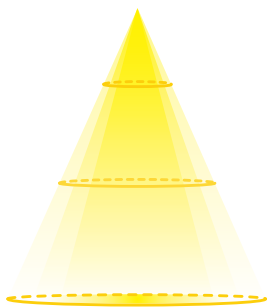

Illuminance at a Distance

Distance		Center Beam fc	Beam Width			
3.0ft	0.91m	3.75fc	2.3ft	0.70m	2.4ft	0.73m
6.0ft	1.83m	0.94fc	4.6ft	1.40m	4.8ft	1.46m
9.0ft	2.74m	0.42fc	6.9ft	2.10m	7.1ft	2.16m
12.0ft	3.65m	0.23fc	9.2ft	2.80m	9.5ft	2.89m
15.0ft	4.57m	0.15fc	11.5ft	3.50m	11.9ft	3.62m
18.0ft	5.48m	0.10fc	13.8ft	4.20m	14.3ft	4.35m

Delivered Lumen: 26.4 lm  
 ■ Vertical Beam Spread: 41.9°  
 ■ Horizontal Beam Spread: 43.3°

1W, Warm Dimming, 83°

Polar Candela Distribution With NA (no accessories)

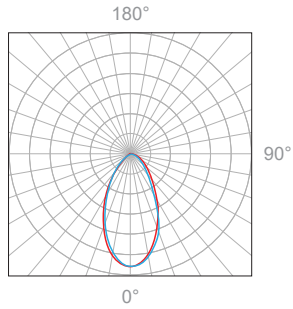

Beam width shown with NA (no accessories)

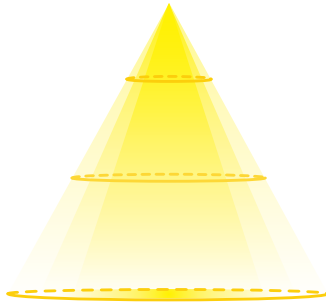

Illuminance at a Distance

Distance		Center Beam fc	Beam Width			
3.0ft	0.91m	2.50fc	5.4ft	1.64m	5.2ft	1.58m
6.0ft	1.83m	0.63fc	10.8ft	3.29m	10.5ft	3.20m
9.0ft	2.74m	0.28fc	16.2ft	4.93m	15.7ft	4.78m
12.0ft	3.65m	0.16fc	21.6ft	6.58m	21.0ft	6.40m
15.0ft	4.57m	0.10fc	27.0ft	8.22m	26.2ft	7.98m
18.0ft	5.48m	0.07fc	32.4ft	9.87m	31.5ft	9.60m

Delivered Lumen: 37 lm  
 ■ Vertical Beam Spread: 83.9°  
 ■ Horizontal Beam Spread: 82.4°

Polar Candela Distribution With HS (half shroud)

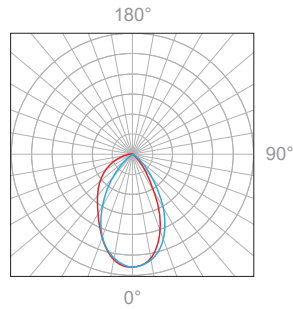

Beam width shown with HS (half shroud)

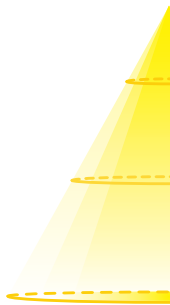

Illuminance at a Distance

Distance		Center Beam fc	Beam Width			
3.0ft	0.91m	2.68fc	4.2ft	1.28m	5.2ft	1.58m
6.0ft	1.83m	0.67fc	8.3ft	2.52m	10.5ft	3.20m
9.0ft	2.74m	0.30fc	12.5ft	3.81m	15.7ft	4.78m
12.0ft	3.65m	0.17fc	16.7ft	5.09m	20.9ft	6.37m
15.0ft	4.57m	0.11fc	20.8ft	6.34m	26.2ft	7.98m
18.0ft	5.48m	0.07fc	25.0ft	7.62m	31.4ft	9.57m

Delivered Lumen: 39.4 lm  
 ■ Vertical Beam Spread: 69.5°  
 ■ Horizontal Beam Spread: 82.2°

Polar Candela Distribution With FS (full shroud)

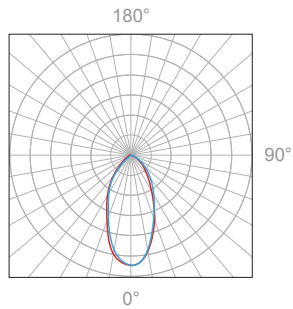

Beam width shown with FS (full shroud)

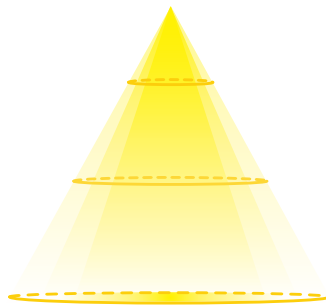

Illuminance at a Distance

Distance		Center Beam fc	Beam Width			
3.0ft	0.91m	2.68fc	3.8ft	1.15m	3.7ft	1.12m
6.0ft	1.83m	0.67fc	7.6ft	2.31m	7.4ft	2.25m
9.0ft	2.74m	0.30fc	11.4ft	3.47m	11.2ft	3.41m
12.0ft	3.65m	0.17fc	15.2ft	4.63m	14.9ft	4.54m
15.0ft	4.57m	0.11fc	19.0ft	5.79m	18.6ft	5.67m
18.0ft	5.48m	0.07fc	22.8ft	6.95m	22.3ft	6.79m

Delivered Lumen: 27 lm  
 ■ Vertical Beam Spread: 64.6°  
 ■ Horizontal Beam Spread: 63.6°

2W, Warm Dimming, 56°

Polar Candela Distribution With NA (no accessories)

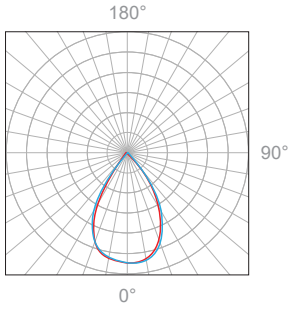

Beam width shown with NA (no accessories)

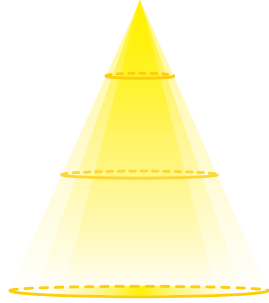

Illuminance at a Distance

Distance		Center Beam fc	Beam Width			
3.0ft	0.91m	48.6fc	1.6ft	0.48m	1.6ft	0.48m
6.0ft	1.83m	12.1fc	3.2ft	0.97m	3.1ft	0.94m
9.0ft	2.74m	5.40fc	4.8ft	1.46m	4.7ft	1.43m
12.0ft	3.65m	3.04fc	6.4ft	1.95m	6.3ft	1.92m
15.0ft	4.57m	1.94fc	8.0ft	2.43m	7.9ft	2.40m
18.0ft	5.48m	1.35fc	9.6ft	2.92m	9.4ft	2.86m

Delivered Lumen: 144.6 lm  
 ■ Vertical Beam Spread: 55.9°  
 ■ Horizontal Beam Spread: 55.4°

Polar Candela Distribution With HS (half shroud)

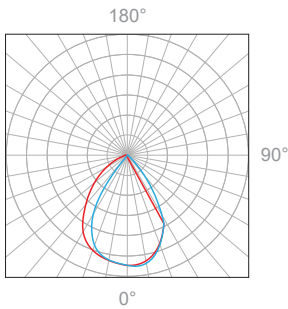

Beam width shown with HS (half shroud)

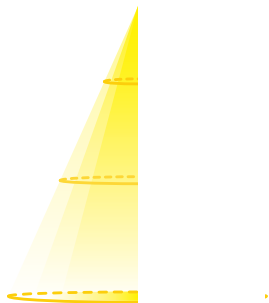

Illuminance at a Distance

Distance		Center Beam fc	Beam Width			
3.0ft	0.91m	8.93fc	2.9ft	0.88m	3.3ft	1.00m
6.0ft	1.83m	2.23fc	5.8ft	1.76m	6.5ft	1.98m
9.0ft	2.74m	0.99fc	8.7ft	2.65m	9.8ft	2.98m
12.0ft	3.65m	0.56fc	11.7ft	3.56m	13.1ft	3.99m
15.0ft	4.57m	0.36fc	14.6ft	4.45m	16.4ft	4.99m
18.0ft	5.48m	0.25fc	17.5ft	5.33m	19.6ft	5.97m

Delivered Lumen: 98.5 lm  
 ■ Vertical Beam Spread: 51.8°  
 ■ Horizontal Beam Spread: 57.2°

Polar Candela Distribution With FS (full shroud)

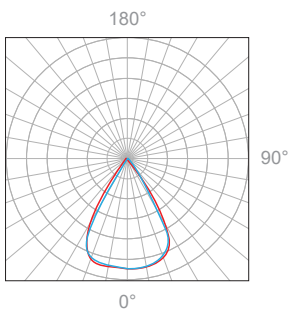

Beam width shown with FS (full shroud)

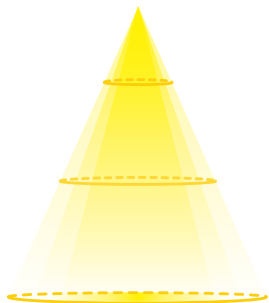

Illuminance at a Distance

Distance		Center Beam fc	Beam Width			
3.0ft	0.91m	9.11fc	2.4ft	0.73m	2.4ft	0.73m
6.0ft	1.83m	2.28fc	4.7ft	1.43m	4.8ft	1.46m
9.0ft	2.74m	1.01fc	7.1ft	2.16m	7.2ft	2.19m
12.0ft	3.65m	0.57fc	9.4ft	2.86m	9.6ft	2.92m
15.0ft	4.57m	0.36fc	11.8ft	3.59m	12.0ft	3.65m
18.0ft	5.48m	0.25fc	14.2ft	4.32m	14.4ft	4.38m

Delivered Lumen: 67.4 lm  
 ■ Vertical Beam Spread: 42.9°  
 ■ Horizontal Beam Spread: 43.6°

2W, Warm Dimming, 83°

Polar Candela Distribution With NA (no accessories)

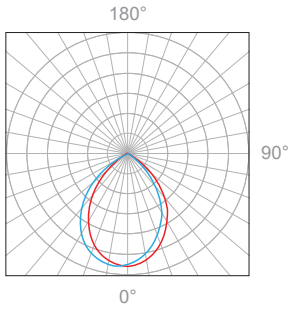

Beam width shown with NA (no accessories)

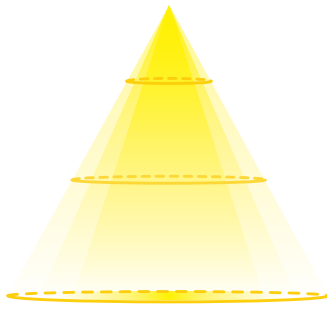

Illuminance at a Distance

Distance		Center Beam fc	Beam Width			
3.0ft	0.91m	29.3fc	2.6ft	0.79m	2.6ft	0.76m
6.0ft	1.83m	7.32fc	5.3ft	1.62m	5.2ft	1.59m
9.0ft	2.74m	3.26fc	7.9ft	2.41m	7.8ft	2.38m
12.0ft	3.65m	1.83fc	10.6ft	3.23m	10.5ft	3.20m
15.0ft	4.57m	1.17fc	13.2ft	4.02m	13.1ft	3.99m
18.0ft	5.48m	0.81fc	15.8ft	4.82m	15.7ft	4.79m

Delivered Lumen: 107.4 lm  
 ■ Vertical Beam Spread: 82.7°  
 ■ Horizontal Beam Spread: 82.1°

Polar Candela Distribution With HS (half shroud)

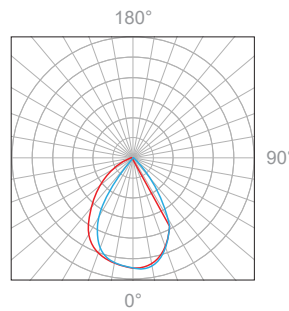

Beam width shown with HS (half shroud)



Illuminance at a Distance

Distance		Center Beam fc	Beam Width			
3.0ft	0.91m	6.79fc	4.5ft	1.37m	5.2ft	1.58m
6.0ft	1.83m	1.70fc	9.1ft	2.77m	10.4ft	3.17m
9.0ft	2.74m	0.75fc	13.6ft	4.14m	15.6ft	4.75m
12.0ft	3.65m	0.42fc	18.1ft	5.51m	20.8ft	6.34m
15.0ft	4.57m	0.27fc	22.6ft	6.88m	26.0ft	7.92m
18.0ft	5.48m	0.19fc	27.2ft	8.29m	31.2ft	9.50m

Delivered Lumen: 99.4 lm  
 ■ Vertical Beam Spread: 74.1°  
 ■ Horizontal Beam Spread: 81.9°

Polar Candela Distribution With FS (full shroud)

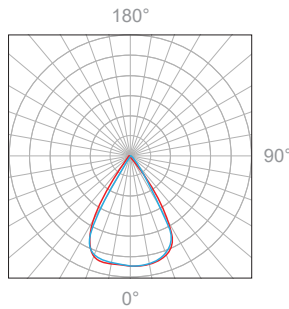

Beam width shown with FS (full shroud)

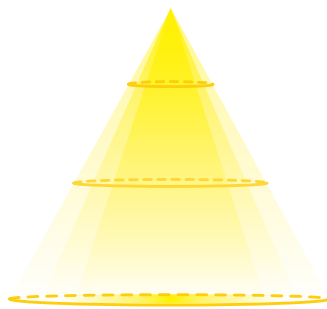

Illuminance at a Distance

Distance		Center Beam fc	Beam Width			
3.0ft	0.91m	6.43fc	3.8ft	1.15m	3.8ft	1.15m
6.0ft	1.83m	7.60fc	7.6ft	2.31m	7.5ft	2.28m
9.0ft	2.74m	0.71fc	11.3ft	3.44m	11.3ft	3.44m
12.0ft	3.65m	0.40fc	15.1ft	4.60m	15.0ft	4.57m
15.0ft	4.57m	0.26fc	18.8ft	5.73m	18.8ft	5.73m
18.0ft	5.48m	0.18fc	22.7ft	6.91m	22.5ft	6.85m

Delivered Lumen: 65.1 lm  
 ■ Vertical Beam Spread: 64.4°  
 ■ Horizontal Beam Spread: 64.1°

Warm Dimming VS. Halogen

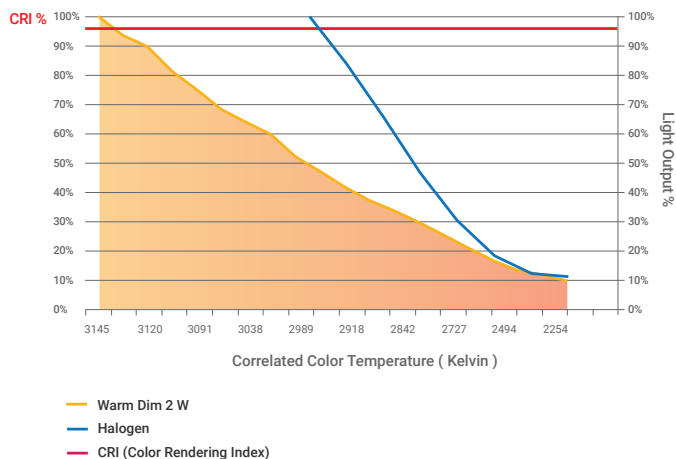



Appendix

Finishes & Material

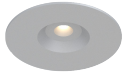

MA matte clear anodized  
120°  
NA no accessories

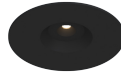

BA black anodized  
120°  
NA no accessories

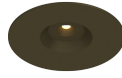

BZ bronze  
120°  
NA no accessories



WH white powder coat  
120°  
NA no accessories



ABZ antique bronze  
120°  
NA no accessories



120°  
HS half shroud

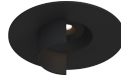

120°  
HS half shroud



120°  
HS half shroud



120°  
HS half shroud

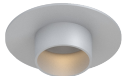

120°  
FS full shroud



120°  
FS full shroud



120°  
FS full shroud



120°  
FS full shroud



12°/30°  
NA no accessories



12°/30°  
NA no accessories



12°/30°  
NA no accessories



12°/30°  
NA no accessories



12°/30°  
HS half shroud



12°/30°  
HS half shroud



12°/30°  
HS half shroud



12°/30°  
HS half shroud



12°/30°  
FS full shroud



12°/30°  
FS full shroud



12°/30°  
FS full shroud



12°/30°  
FS full shroud



10°  
LBSHS long black shroud