

L614

INTERIOR

Surface-mount Downlight | For ceilings

● Dry location

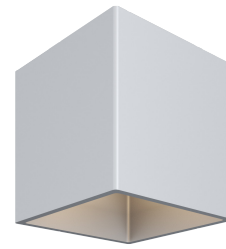

Ordering Information

Clear Form

Date : _____

Quantity : _____

Project : _____

Note : _____

Type : _____

Specifications

Luminaire | Example Code: L614-13-W30-V-N-BZ-B-MA

| Product | Version | CCT ¹ | CRI | Beam Angle | Reflector Colour | Surface-mount Box ⁶ (optional) | Finish ⁷ |
|-------------|---------|--|--|---|--|--|--------------------------------|
| L614 | 13 13W | W27 2700K | H 90+ CRI | S spot 12° | S silver specular | B surface-mount box | MA matte clear anodized |
| | 26 26W | W30 3000K W35 3500K | V 97+ CRI ³ | N narrow flood 30° F flood 45° W wide flood 60° ⁵ | B black specular BZ bronze specular G gold specular | | |
| | | WD warm dimming (1800-3000K, 95+ CRI) ² | Consult Factory: DAY = Daylight Spectrum, 97+ CRI ⁴ | | | | |

System Components (Ordered Separately)

Remote Driver : _____

* Consult MP Lighting Website or Factory.

Important Notes

Specification

1. Refer to pg.02 - for Light Quality & Colour Consistency details.
2. Refer to pg.6 or [Warm Dimming](#) for details.
3. V 97+CRI: only available with W27&W30
4. DAY (Daylight Spectrum): only available with W30
5. W (wide flood 60°) is not available with 26W, WD (warm dimming) option.
6. Refer to pg.03 - for images and installation guide.
7. Refer to Appendix or MP Lighting website for complete look of luminaire with different finish options.

Warranty Notes & Disclaimer

Malfunction and damage to product due to incompatible dimming system or misuse will not be covered under warranty. Consult MP Lighting for recommended drivers. If the fixture has an option to be installed with a dimming control system, consult a dimming system manufacturer with minimum load before installing. MP Lighting reserves the right, at its sole discretion, at any time and without notice, to make design changes to any of our products. Consult MP Lighting website for most updated documentation.

L614

INTERIOR

Surface-mount Downlight | For ceilings

- Dry location

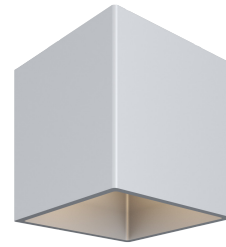

Performance

| Wattage | Input Voltage | Power Consumption Budget per fixture (including driver) | LED output (Source) | Fixture Output (Delivered) |
|---------|---------------|---|---------------------|----------------------------|
| 13W | 120-277V | 13W | 1430 lm | 1081~1269 lm |
| 26W | 120-277V | 26W | 2860 lm | 1895~2235 lm |

Application

| | |
|-------------|--|
| Environment | Dry Location approved. IP 20. |
| Mounting | Mounts with built-in surface-mount box (optional) or mounts to a 4" octagonal box (supplied by others) |

Electrical

| | |
|------------|--|
| Electrical | Remote LED drivers (120-277V AC input, constant current output) |
| Control | On/off control Dimming: ELV or 0-10V dimming with appropriate drivers Other options (consult factory): TRIAC/MLV, DMX, DALI, Casambi, Power over Ethernet |

Luminaire Construction

| | |
|---------------------|--|
| LED Light Source | W27H = CCT: 2700K, CRI (Ra): 90+, Colour Consistency: 2SDCM W30H = CCT: 3000K, CRI (Ra): 90+, Colour Consistency: 2SDCM W35H = CCT: 3500K, CRI (Ra): 90+, Colour Consistency: 2SDCM W27V = CCT: 2700K, CRI (Ra): 97+, Colour Consistency: 2SDCM W30V = CCT: 3000K, CRI (Ra): 97+, Colour Consistency: 2SDCM WD = CCT: 1800K-3000K, CRI (Ra): 95+ DAY = CCT: 3000K only, CRI (Ra): 97+ |
| Weight | N/A |
| Material | Fixture: machined marine-grade aluminum |
| Supplied with | N/A |
| Warranty & LED Life | 5 years limited warranty Estimated useful life of LED is 50,000 hours. |

Ordered Separately

| | |
|-------------------|---|
| System Components | Power supplies: remote driver Please consult factory or visit Recommended Drivers for available driver options. |
|-------------------|---|

Mounting Options & Dimensions

LED Fixture Dimensions

Fixture

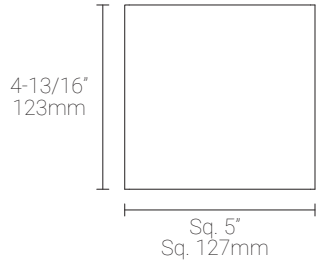

Bottom View

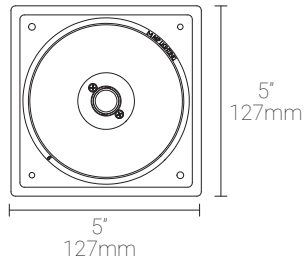

3D View



Beam

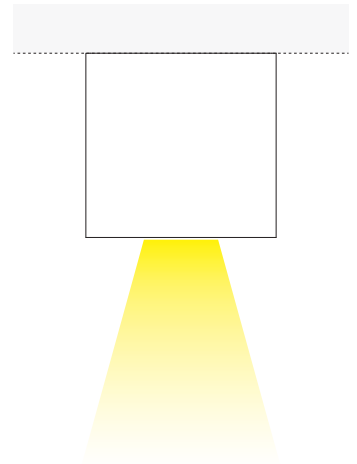

LED Fixture Dimensions | with B, surface-mount box (optional)

Fixture

Conduit knockout size: $\varnothing 3/4"$
($\varnothing 19\text{mm}$)

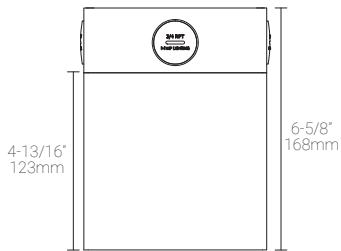

Bottom View

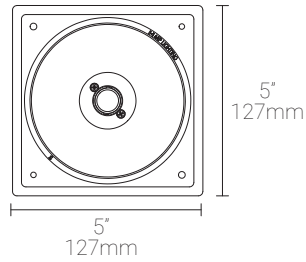

3D View



Beam

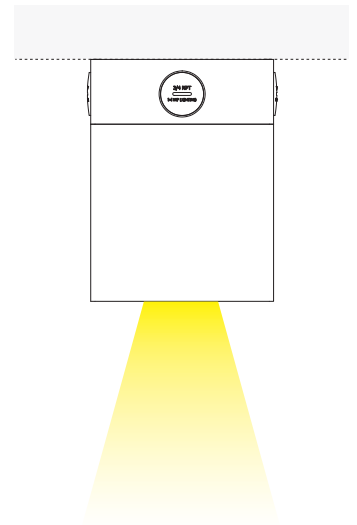

Surface-mount box
(to be painted on site)

Mounting Options & Dimensions

Installation with standard 4" octagonal back box (supplied by others)

Ceiling mounted

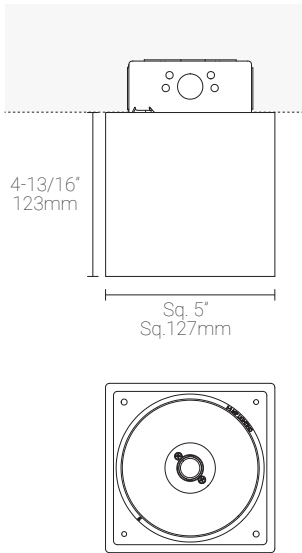

Installation with B, surface-mount box (optional)

Ceiling mounted

Conduit knockout size: $\varnothing 3/4"$
($\varnothing 19\text{mm}$)

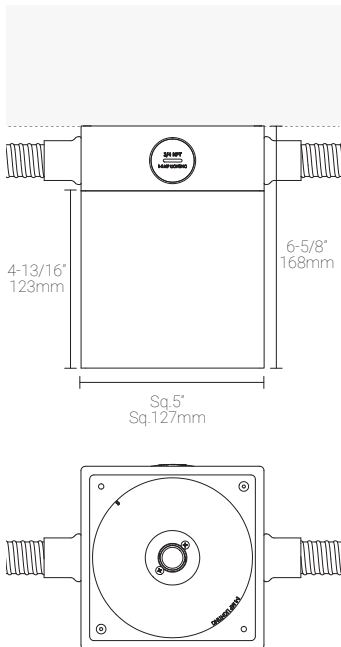

13W, 3000K, 80+ CRI, Silver Reflector

Polar Candela Distribution

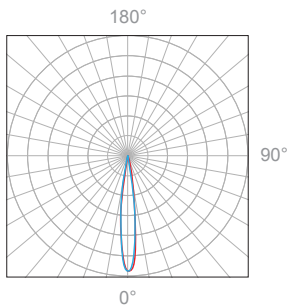

Beam Width: 12°



Illuminance at a Distance

| Distance | | Center Beam fc | Beam Width | | | |
|----------|-------|----------------|------------|-------|-------|-------|
| 3.0ft | 0.91m | 2006fc | 0.6ft | 0.18m | 0.6ft | 0.18m |
| 6.0ft | 1.83m | 501fc | 1.1ft | 0.34m | 1.1ft | 0.34m |
| 9.0ft | 2.74m | 223fc | 1.7ft | 0.52m | 1.7ft | 0.52m |
| 12.0ft | 3.66m | 125fc | 2.2ft | 0.67m | 2.2ft | 0.67m |
| 15.0ft | 4.57m | 80.2fc | 2.8ft | 0.85m | 2.8ft | 0.85m |
| 18.0ft | 5.49m | 55.7fc | 3.3ft | 1.01m | 3.3ft | 1.01m |

Delivered Lumen: 1269.3lm
 ■ Vertical Beam Spread: 10.6°
 ■ Horizontal Beam Spread: 10.5°

Polar Candela Distribution

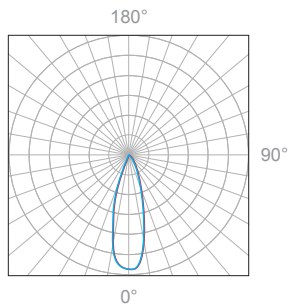

Beam Width: 30°

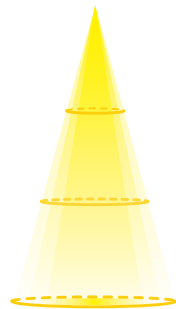

Illuminance at a Distance

| Distance | | Center Beam fc | Beam Width | | | |
|----------|-------|----------------|------------|-------|-------|-------|
| 3.0ft | 0.91m | 355fc | 1.6ft | 0.49m | 1.6ft | 0.49m |
| 6.0ft | 1.83m | 88.7fc | 3.3ft | 1.01m | 3.3ft | 1.01m |
| 9.0ft | 2.74m | 39.4fc | 4.9ft | 1.49m | 4.9ft | 1.49m |
| 12.0ft | 3.66m | 22.2fc | 6.6ft | 2.01m | 6.6ft | 2.01m |
| 15.0ft | 4.57m | 14.2fc | 8.2ft | 2.50m | 8.2ft | 2.50m |
| 18.0ft | 5.49m | 9.85fc | 9.8ft | 2.99m | 9.8ft | 2.99m |

Delivered Lumen: 1132.8lm
 ■ Vertical Beam Spread: 30.6°
 ■ Horizontal Beam Spread: 30.6°

Polar Candela Distribution

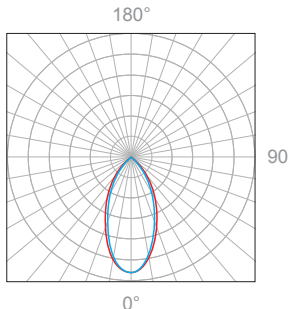

Beam Width: 45°

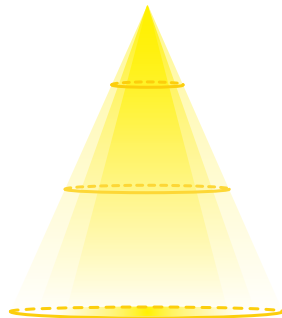

Illuminance at a Distance

| Distance | | Center Beam fc | Beam Width | | | |
|----------|-------|----------------|------------|-------|--------|-------|
| 3.0ft | 0.91m | 240fc | 2.2ft | 0.67m | 2.2ft | 0.67m |
| 6.0ft | 1.83m | 59.9fc | 4.3ft | 1.31m | 4.3ft | 1.31m |
| 9.0ft | 2.74m | 26.6fc | 6.5ft | 1.98m | 6.5ft | 1.98m |
| 12.0ft | 3.66m | 15fc | 8.6ft | 2.62m | 8.6ft | 2.62m |
| 15.0ft | 4.57m | 9.58fc | 10.8ft | 3.29m | 10.8ft | 3.29m |
| 18.0ft | 5.49m | 6.65fc | 12.9ft | 3.93m | 12.9ft | 3.93m |

Delivered Lumen: 1160lm
 ■ Vertical Beam Spread: 39.4°
 ■ Horizontal Beam Spread: 38.5°

Polar Candela Distribution

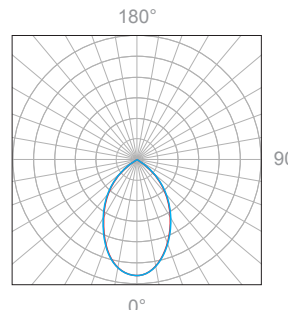

Beam Width: 60°

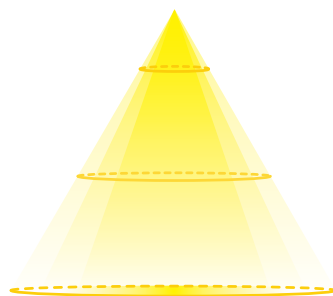

Illuminance at a Distance

| Distance | | Center Beam fc | Beam Width | | | |
|----------|-------|----------------|------------|-------|--------|-------|
| 3.0ft | 0.91m | 172fc | 2.6ft | 0.79m | 2.6ft | 0.79m |
| 6.0ft | 1.83m | 43.1fc | 5.2ft | 1.58m | 5.2ft | 1.58m |
| 9.0ft | 2.74m | 19.1fc | 7.9ft | 2.41m | 7.9ft | 2.41m |
| 12.0ft | 3.66m | 10.8fc | 10.5ft | 3.20m | 10.5ft | 3.20m |
| 15.0ft | 4.57m | 6.89fc | 13.1ft | 3.99m | 13.1ft | 3.99m |
| 18.0ft | 5.49m | 4.78fc | 15.7ft | 4.79m | 15.7ft | 4.79m |

Delivered Lumen: 1080.6lm
 ■ Vertical Beam Spread: 47.2°
 ■ Horizontal Beam Spread: 48.2°

26W, 3000K, 80+ CRI, Silver Reflector

Polar Candela Distribution

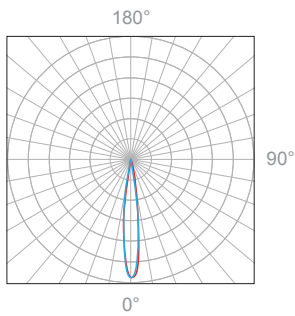

Beam Width: 12°



Illuminance at a Distance

| Distance | | Center Beam fc | Beam Width | | | |
|----------|-------|----------------|------------|-------|-------|-------|
| 3.0ft | 0.91m | 3544fc | 0.6ft | 0.18m | 0.6ft | 0.18m |
| 6.0ft | 1.83m | 886fc | 1.1ft | 0.34m | 1.1ft | 0.34m |
| 9.0ft | 2.74m | 394fc | 1.7ft | 0.52m | 1.7ft | 0.52m |
| 12.0ft | 3.66m | 221fc | 2.2ft | 0.67m | 2.2ft | 0.67m |
| 15.0ft | 4.57m | 142fc | 2.8ft | 0.85m | 2.8ft | 0.85m |
| 18.0ft | 5.49m | 98.4fc | 3.3ft | 1.01m | 3.3ft | 1.01m |

Delivered Lumen: 2235.4lm
 ■ Vertical Beam Spread: 10.6°
 ■ Horizontal Beam Spread: 10.5°

Polar Candela Distribution

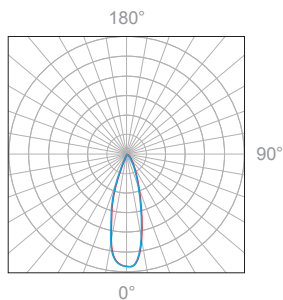

Beam Width: 30°

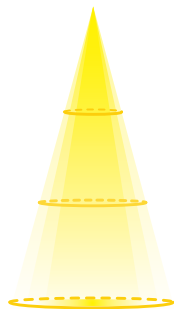

Illuminance at a Distance

| Distance | | Center Beam fc | Beam Width | | | |
|----------|-------|----------------|------------|-------|-------|-------|
| 3.0ft | 0.91m | 628fc | 1.6ft | 0.49m | 1.6ft | 0.49m |
| 6.0ft | 1.83m | 157fc | 3.3ft | 1.01m | 3.3ft | 1.01m |
| 9.0ft | 2.74m | 69.8fc | 4.9ft | 1.49m | 4.9ft | 1.49m |
| 12.0ft | 3.66m | 39.3fc | 6.6ft | 2.01m | 6.6ft | 2.01m |
| 15.0ft | 4.57m | 25.1fc | 8.2ft | 2.50m | 8.2ft | 2.50m |
| 18.0ft | 5.49m | 17.4fc | 9.8ft | 2.99m | 9.8ft | 2.99m |

Delivered Lumen: 2000.2lm
 ■ Vertical Beam Spread: 30.8°
 ■ Horizontal Beam Spread: 30.6°

Polar Candela Distribution

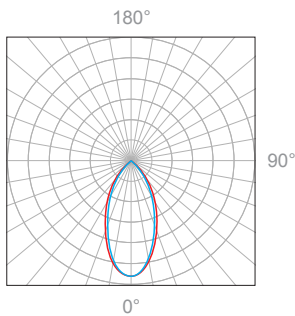

Beam Width: 45°

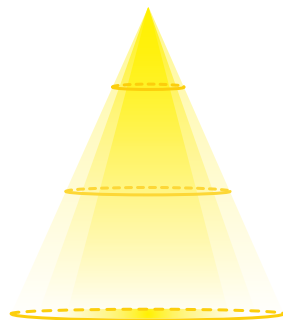

Illuminance at a Distance

| Distance | | Center Beam fc | Beam Width | | | |
|----------|-------|----------------|------------|-------|--------|-------|
| 3.0ft | 0.91m | 240fc | 2.1ft | 0.64m | 2.1ft | 0.64m |
| 6.0ft | 1.83m | 59.9fc | 4.3ft | 1.31m | 4.2ft | 1.28m |
| 9.0ft | 2.74m | 26.6fc | 6.4ft | 1.96m | 6.3ft | 1.92m |
| 12.0ft | 3.66m | 15fc | 8.6ft | 2.62m | 8.3ft | 2.53m |
| 15.0ft | 4.57m | 9.58fc | 10.7ft | 3.26m | 10.4ft | 3.17m |
| 18.0ft | 5.49m | 6.65fc | 12.8ft | 3.90m | 12.5ft | 3.81m |

Delivered Lumen: 1962.8lm
 ■ Vertical Beam Spread: 39.3°
 ■ Horizontal Beam Spread: 38.4°

Polar Candela Distribution

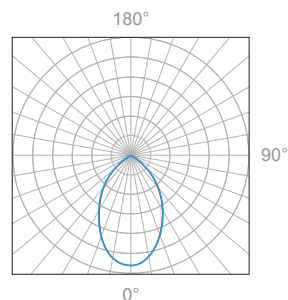

Beam Width: 60°

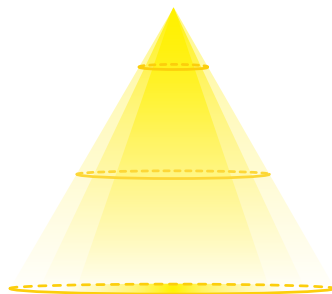

Illuminance at a Distance

| Distance | | Center Beam fc | Beam Width | | | |
|----------|-------|----------------|------------|-------|--------|-------|
| 3.0ft | 0.91m | 304fc | 2.7ft | 0.79m | 2.7ft | 0.82m |
| 6.0ft | 1.83m | 76.1fc | 5.4ft | 1.58m | 5.3ft | 1.62m |
| 9.0ft | 2.74m | 33.8fc | 8.0ft | 2.41m | 8.0ft | 2.44m |
| 12.0ft | 3.66m | 19fc | 10.7ft | 3.20m | 10.6ft | 3.23m |
| 15.0ft | 4.57m | 12.2fc | 13.4ft | 3.99m | 13.3ft | 4.05m |
| 18.0ft | 5.49m | 8.46fc | 16.1ft | 4.79m | 15.9ft | 4.85m |

Delivered Lumen: 1895.1lm
 ■ Vertical Beam Spread: 48.2°
 ■ Horizontal Beam Spread: 47.7°

Warm Dimming VS. Halogen

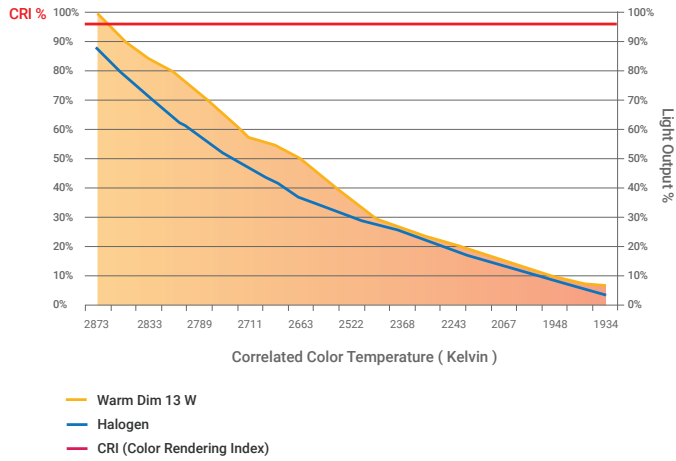

Full Spectrum

Full Spectrum Standard Illuminant @ 3000K Ra≥80

