

U312

UNDERWATER: CHLORINATED WATER & FRESHWATER

In-grade | Submersed under water up to 10' (3m) depth.

- Underwater/Swimming Pool Certified

CSA - CLASS 3425 09 -Submersible

CSA - CLASS 3425 89 -Submersible - Certified to US Standards



Ordering Information

Clear Form

Date : _____ Quantity : _____

Project : _____ Note : _____

Type : _____

Specifications

Luminaire | Example Code: U312-2-W30H-S-C-LM-0-MK1-B-15-S6

Product	Version	CCT & CRI ¹	Beam Angle	Lens	Accessories ² (optional)	Mounting Kit ³ (optional)	Flange & Back Box ⁴	Lead Length ⁵	Trim Finish ⁶
U312									S6
	1 1W 2 2W	W22H 2200K 90+ W27H 2700K 90+ W30H 3000K 90+ W35H 3500K 90+	S spot 12° N narrow flood 30°	C clear F frosted	LM louver, matte anodized LB louver, black anodized HM hex louver, matte anodized HB hex louver, black anodized AB angled louver, black anodized SB straight louver, black anodized QB square louver, black anodized RB ring louver, black anodized	MK1 vertical surface	B back box F flange only	15 15' (4572mm) X custom	S6 stainless steel 316

System Components (Ordered Separately)

Remote Driver : _____

* Consult MP Lighting Website or Factory.

Order Guide Important Notes

1. Refer to pg.2 - for Colour Consistency details.
2. Louvers will be below the glass cover. Only available when there is no Internal Angle Bracket.
3. Mounting kit is ordered separately. Please consult factory.
4. For components included, refer to Luminaire Construction section. For custom box and flange options, consult MP factory.
5. Custom lengths available by 1' increments.
6. Different finish options are only applicable to trim ring and not for LED module housing. Refer to Appendix or MP Lighting website for complete look of luminaire with different trim finish options.

Warranty Notes & Disclaimer

Malfunction and damage to product due to incompatible dimming system or misuse will not be covered under warranty. Consult MP Lighting for recommended drivers. If the fixture has an option to be installed with a dimming control system, consult a dimming system manufacturer with minimum load before installing. MP Lighting reserves the right, at its sole discretion, at any time and without notice, to make design changes to any of our products. Consult MP Lighting website for most updated documentation.

U312

UNDERWATER: CHLORINATED WATER & FRESHWATER

In-grade | Submersed under water up to 10' (3m) depth.

- Underwater/Swimming Pool Certified

CSA - CLASS 3425 09 -Submersible

CSA - CLASS 3425 89 -Submersible - Certified to US Standards

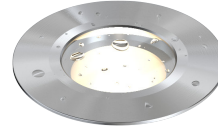

Performance

Wattage	Forward Current	Power Consumption Budget per fixture (including driver)	LED output (Source)	Fixture Output (Delivered)
1W	350mA	1.3W	110 lm	43-52 lm
2W	700mA	2.6W	220 lm	69-70 lm

Application

Environment	Underwater / Wet / Damp / Dry Location approved. IP 68.
Mounting	Recessed: Designed to be cast into earth, gravel, or concrete for submersed applications. MK1 mounting kit (optional): Recommended for easy installation on vertical surfaces (e.g. stair risers, walls), and downward-facing surfaces (e.g. ceilings, soffits). See "Mounting Options & Dimensions," or visit MK1

Electrical

Power Supplies	Compatible with pool-certified power supplies
Control	On/off control

Luminaire Construction

LED Light Source	W22H = CCT: 2200K, CRI (Ra): 90+, Colour Consistency: 3SDCM W27H = CCT: 2700K, CRI (Ra): 90+, Colour Consistency: 2SDCM W30H = CCT: 3000K, CRI (Ra): 90+, Colour Consistency: 2SDCM W35H = CCT: 3500K, CRI (Ra): 90+, Colour Consistency: 2SDCM
Weight	1.8 lbs (0.816 kg). Typical stainless steel 316 Insert & Back Box only.
Material	Fixture: Stainless steel (316) or antique bronze with tempered glass.
Supplied with	Standard installation housing: Comes with a 304 stainless steel square back box, an brass/stainless steel 316 flange, an integral leveling device, a plastic cap, gel filled wire nuts, and silicone grease. Wire lead: 15' (4572mm) or custom length
Warranty & LED Life	5 years limited warranty Estimated useful life of LED is 50,000 hours.

Ordered Separately

System Components	Power supplies: remote driver Mounting kits: MK1
-------------------	---

Mounting Options & Dimensions

LED Insert Dimensions

Fixture

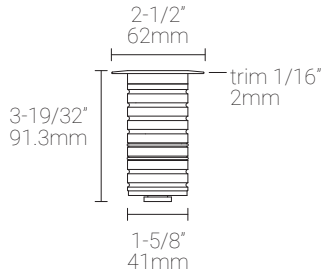

Top View

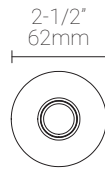

3D View

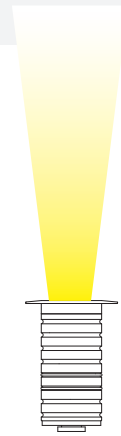

In-ground Installation (shown with MP Lighting Back Box)

Box with Standard Flange

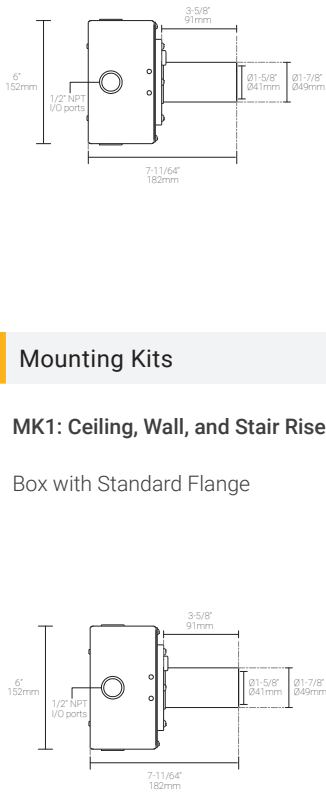

Box with Short Flange:
During Concrete Installation

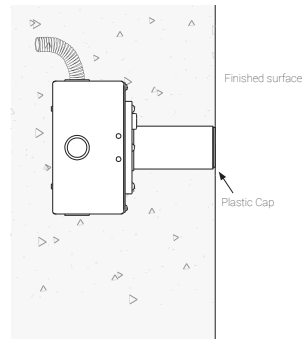

Box with Short Flange:
Complete Concrete Installation

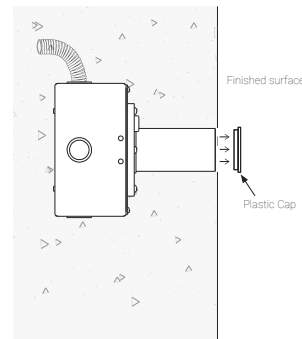

Box with Short Flange:
Complete Concrete Installation

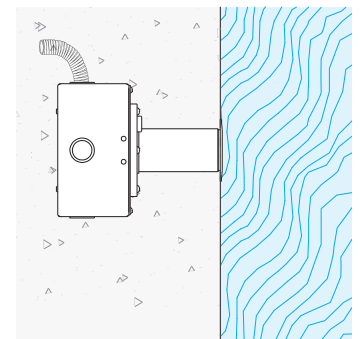

Mounting Kits

MK1: Ceiling, Wall, and Stair Riser Installation (shown with MP Lighting Back Box)

Box with Standard Flange

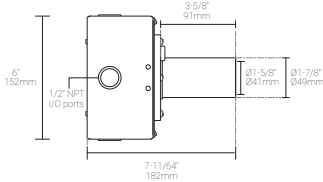

Box with Standard Flange & MK1:
During Installation

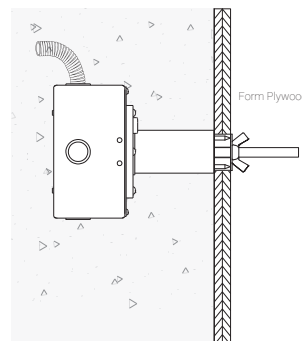

Box with Standard Flange:
Complete Installation

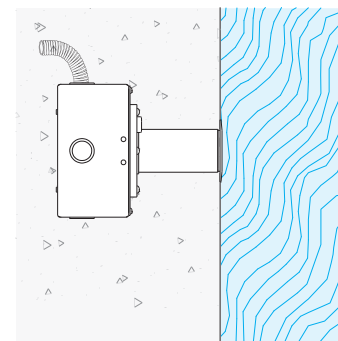

1W, 3000K, 90+ CRI

Polar Candela Distribution

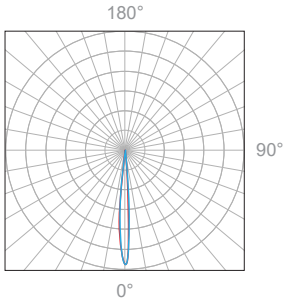

Beam Width: 12°



Illuminance at a Distance

Distance		Center Beam fc	Beam Width			
1.5ft	0.46m	171fc	0.5ft	0.15m	0.5ft	0.15m
3.0ft	0.91m	48fc	1.0ft	0.30m	1.0ft	0.30m
4.5ft	1.37m	21fc	1.6ft	0.49m	1.6ft	0.49m
6.0ft	1.83m	9.8fc	2.1ft	0.64m	2.1ft	0.64m
7.5ft	2.29m	6.2fc	2.6ft	0.79m	2.6ft	0.79m
9.0ft	2.74m	4.4fc	3.1ft	0.95m	3.1ft	0.95m

Delivered Lumen: 43lm
 ■ Vertical Beam Spread: 14.0°
 ■ Horizontal Beam Spread: 14.3°

Polar Candela Distribution

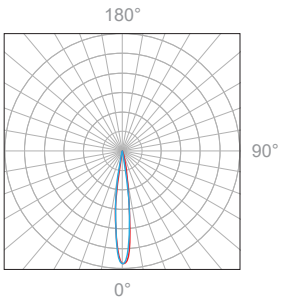

Beam Width: 30°

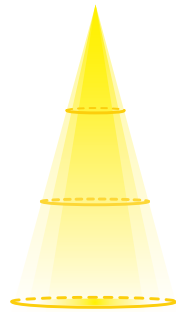

Illuminance at a Distance

Distance		Center Beam fc	Beam Width			
1.5ft	0.46m	133fc	0.8ft	0.24m	0.8ft	0.24m
3.0ft	0.91m	37fc	1.7ft	0.52m	1.6ft	0.49m
4.5ft	1.37m	16fc	2.5ft	0.76m	2.5ft	0.76m
6.0ft	1.83m	10fc	3.3ft	1.01m	3.3ft	1.01m
7.5ft	2.29m	6.9fc	4.2ft	1.28m	4.1ft	1.25m
9.0ft	2.74m	4.5fc	5.0ft	1.52m	4.9ft	1.52m

Delivered Lumen: 52lm
 ■ Vertical Beam Spread: 32.5°
 ■ Horizontal Beam Spread: 32.1°

2W, 3000K, 90+ CRI

Polar Candela Distribution

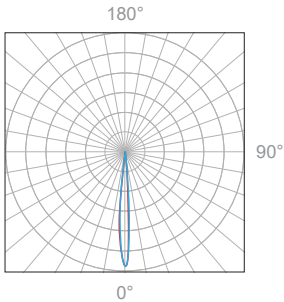

Beam Width: 12°



Illuminance at a Distance

Distance		Center Beam fc	Beam Width			
1.5ft	0.46m	322fc	0.5ft	0.15m	0.5ft	0.15m
3.0ft	0.91m	89fc	1.0ft	0.30m	1.0ft	0.30m
4.5ft	1.37m	39fc	1.6ft	0.49m	1.6ft	0.49m
6.0ft	1.83m	22fc	2.1ft	0.64m	2.1ft	0.64m
7.5ft	2.29m	14fc	2.6ft	0.79m	2.6ft	0.79m
9.0ft	2.74m	9.6fc	3.1ft	0.95m	3.1ft	0.95m

Delivered Lumen: 69lm
 ■ Vertical Beam Spread: 19.2°
 ■ Horizontal Beam Spread: 19.2°

Polar Candela Distribution

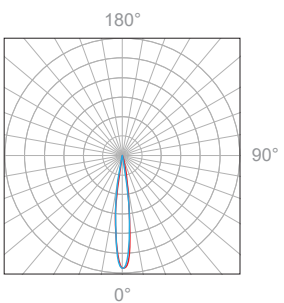

Beam Width: 30°

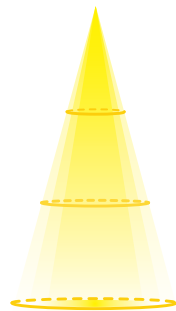

Illuminance at a Distance

Distance		Center Beam fc	Beam Width			
1.5ft	0.46m	253fc	0.8ft	0.24m	0.8ft	0.52m
3.0ft	0.91m	69fc	1.5ft	0.46m	1.5ft	0.46m
4.5ft	1.37m	31fc	2.3ft	0.70m	2.3ft	0.70m
6.0ft	1.83m	17fc	3.1ft	0.94m	3.0ft	0.91m
7.5ft	2.29m	11fc	3.8ft	1.16m	3.8ft	1.16m
9.0ft	2.74m	7.9fc	4.6ft	1.40m	10.4ft	1.40m

Delivered Lumen: 70lm
 ■ Vertical Beam Spread: 28.5°
 ■ Horizontal Beam Spread: 28.5°

TM30 Report

2700K, 90+CRI

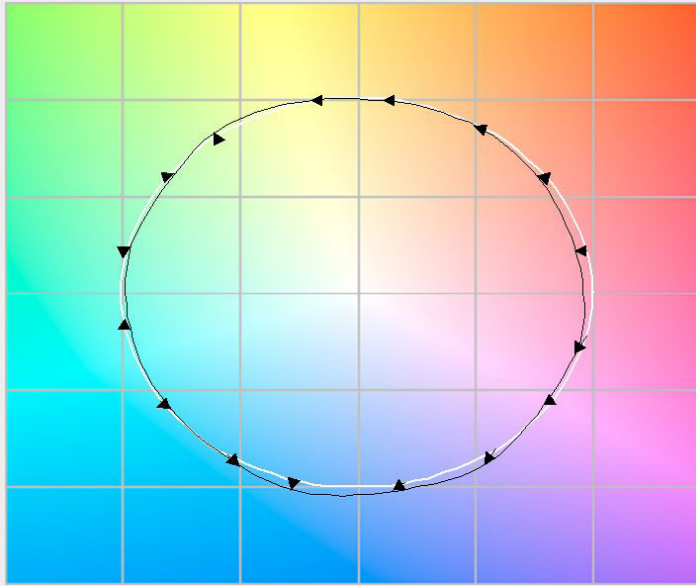

3000K, 90+CRI

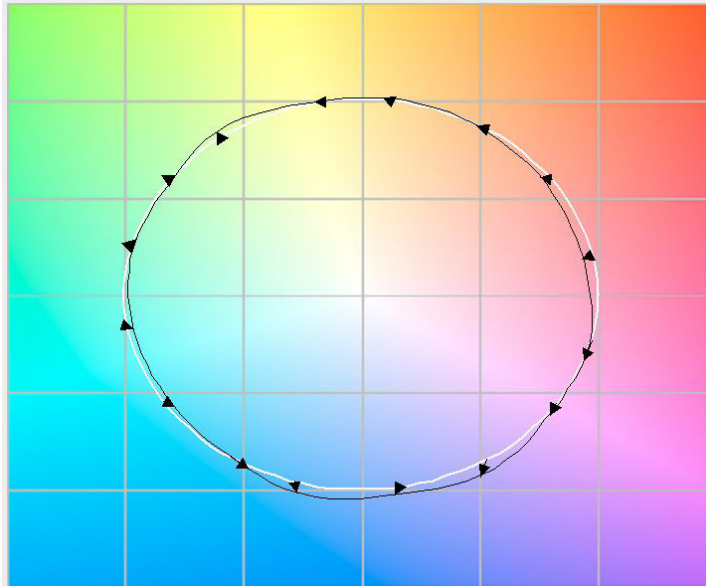

3500K, 90+CRI

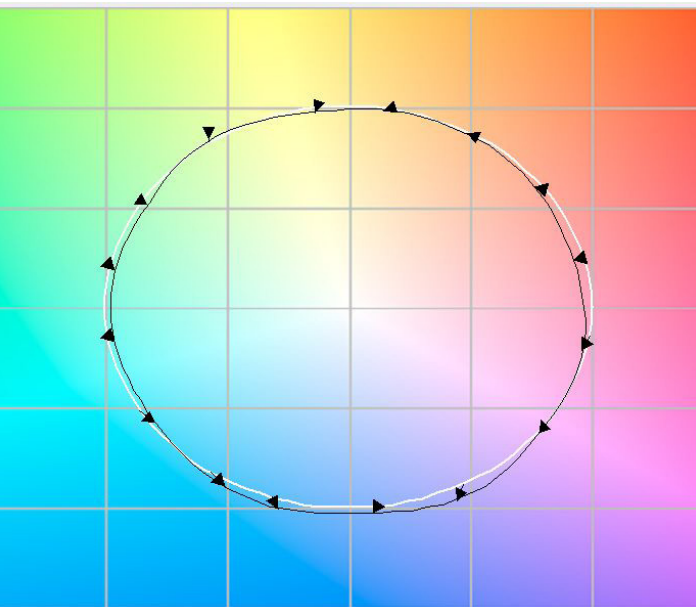

Appendix



S6 stainless steel 316

Accessories



LM louver, matte clear anodized



LB louver, black anodized



HM hex louver, matte clear anodized



HB hex louver, black anodized



AB angled louver, black anodized



SB straight louver, black anodized



QB square louver, black anodized



RB ring louver, black anodized