

U368

UNDERWATER: CHLORINATED WATER & FRESH WATER
 In-grade | Submersed under water up to 10' (3m) depth.

- Underwater/Swimming Pool Certified

CSA - CLASS 3425 09 -Submersible

CSA - CLASS 3425 89 -Submersible - Certified to US Standards

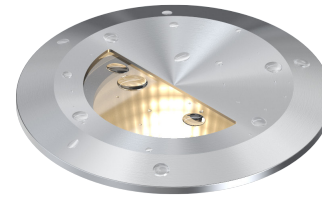

Ordering Information

Clear Form

Date : _____

Quantity : _____

Project : _____

Note : _____

Type : _____

Specifications

Luminaire | Example Code: U368-8-W30H-N-S-C-RB2-MK1-B-15-S6

Product	Version	CCT & CRI ¹	Beam Angle	Lens	Accessories (optional)	Mounting Kit ² (optional)	Flange & Back Box	Lead Length ³	Trim Finish
U368									S6
	4 4W 8 8W	W27H 2700K 90+ W30H 3000K 90+	S spot 12° N narrow flood 30°	C clear F frosted	HM2 hex louver, matte anodized HB2 hex louver, black anodized AB2 angled louver, black anodized SB2 straight louver, black anodized QB2 square louver, black anodized RB2 ring louver, black anodized	MK1 vertical surface	B back box F flange only	15 15' (4572mm) X custom	Stainless Steel Finish: S6 stainless steel 316

System Components (Ordered Separately)

Pool-certified power supply : _____

* Consult MP Lighting Website or Factory.

Important Notes

Specification

1. Refer to pg.2 - for Colour Consistency details.
2. Mounting kit is ordered separately. Please consult factory.
3. Custom length available by 1' increments.

Warranty Notes & Disclaimer

Malfunction and damage to product due to incompatible dimming system or misuse will not be covered under warranty. Consult MP Lighting for recommended drivers. If the fixture has an option to be installed with a dimming control system, consult a dimming system manufacturer with minimum load before installing. MP Lighting reserves the right, at its sole discretion, at any time and without notice, to make design changes to any of our products. Consult MP Lighting website for most updated documentation.

U368

UNDERWATER: CHLORINATED WATER & FRESH WATER
 In-grade | Submersed under water up to 10' (3m) depth.

- Underwater/Swimming Pool Certified

CSA - CLASS 3425 09 -Submersible

CSA - CLASS 3425 89 -Submersible - Certified to US Standards

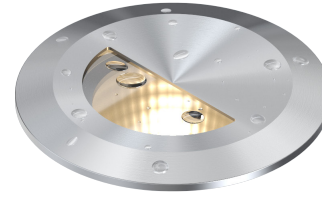

Performance

Wattage	Forward Current	Power Consumption Budget per fixture (including driver)	LED output (Source)	Fixture Output (Delivered)
4W	350mA	4.0W	440 lm	140-164 lm
8W	700mA	8.0W	880 lm	247-275 lm

Application

Environment	Underwater/ Wet/ Damp/ Dry Location approved. IP 68.
Mounting	Recessed: Designed to be cast into earth, gravel, or concrete for submersed applications. MK1 mounting kit (optional): Recommended for easy installation on vertical surfaces (e.g. stair risers, walls), and downward-facing surfaces (e.g. ceilings, soffits). See "Mounting Options & Dimensions," or visit MK1

Electrical

Power Supplies	Compatible with remote pool-certified power supplies
Control	On/off control

Luminaire Construction

LED Light Source	W27H = CCT: 2700K, CRI (Ra): 90+, Colour Consistency: 2SDCM W30H = CCT: 3000K, CRI (Ra): 90+, Colour Consistency: 2SDCM
Weight	N/A
Material	Fixture: Stainless steel (316) with tempered glass
Supplied with	Standard installation housing: Comes with a 304 stainless steel square back box, an brass/stainless steel 316 flange, an integral leveling device, a plastic cap, and silicone grease. Wire lead: 15' (4572mm)
Warranty & LED Life	5 years limited warranty Estimated useful life of LED is 50,000 hours.

Ordered Separately

System Components	Power supplies: remote power supply Please consult factory or visit Recommended Drivers for available driver options. Mounting kits: MK1
-------------------	--

Mounting Options & Dimensions

LED Insert Dimensions

Fixture

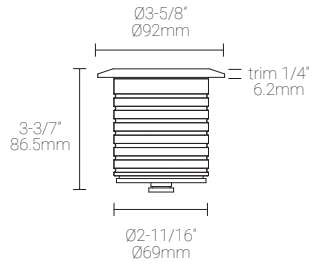

Top View

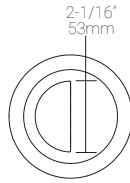

3D View



In-ground Installation (shown with MP Lighting Back Box | Order Code: EBX-SQR1-DSBR)

Box with Standard Flange

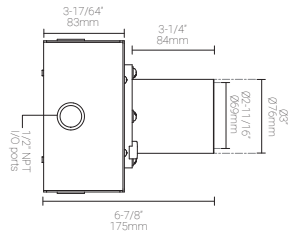

Box with Standard Flange:
During Concrete Installation

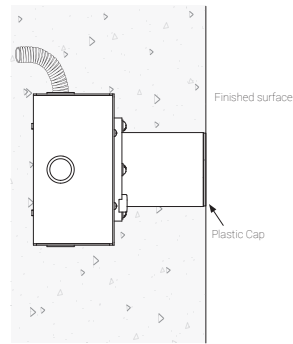

Box with Standard Flange:
During Concrete Installation

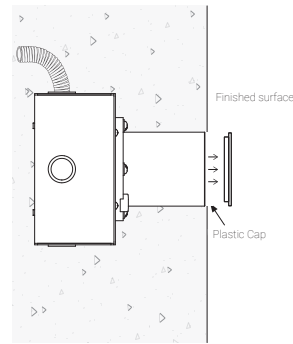

Box with Standard Flange:
Complete Concrete Installation

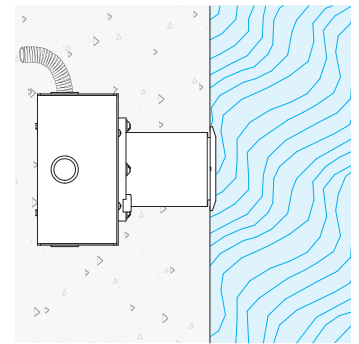

Mounting Kit

MK1: Ceiling, Wall, and Stair Riser Installation (shown with MP Lighting Back Box | Order Code: EBX-SQR1-DSBR)

Box with Standard Flange

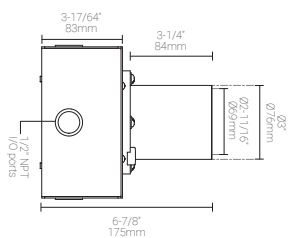

Box with Standard Flange & MK1:
During Installation

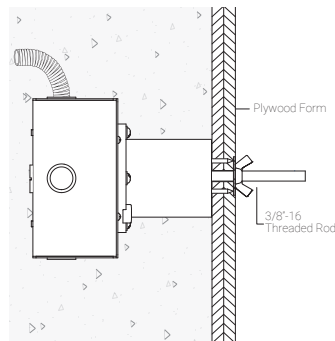

Box with Standard Flange:
Complete Installation

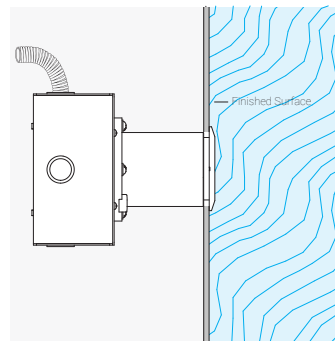

6" (152mm) threaded rod is supplied. Thread size: 3/8"-16

4W, 3000K, 90+ CRI, Clear Lens

Polar Candela Distribution

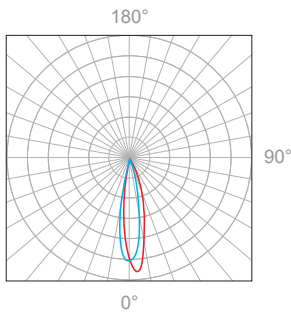

Beam Width: 12°



Illuminance at a Distance

Distance		Center Beam	Beam Width			
1.5ft	0.46m	1394fc	0.5ft	0.15m	0.5ft	0.15m
3.0ft	0.91m	347fc	1.0ft	0.30m	1.0ft	0.30m
4.5ft	1.37m	150fc	1.5ft	0.46m	1.5ft	0.46m
6.0ft	1.83m	85fc	2.0ft	0.61m	2.0ft	0.61m
7.5ft	2.29m	52fc	2.5ft	0.76m	2.5ft	0.76m
9.0ft	2.74m	36fc	3.1ft	0.94m	3.1ft	0.94m
12ft	3.66m	21fc	4.1ft	1.25m	4.1ft	1.25m
15ft	4.57m	13fc	5.1ft	1.55m	5.1ft	1.55m
18ft	5.49m	9fc	6.1ft	1.86m	6.1ft	1.86m

Delivered Lumen: 140 lm
 ■ Vertical Beam Spread: 16.5°
 ■ Horizontal Beam Spread: 15.7°

Polar Candela Distribution

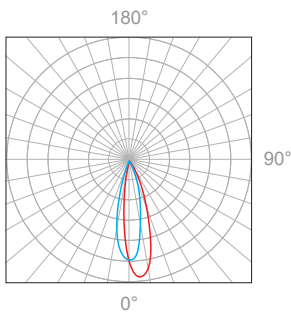

Beam Width: 30°



Illuminance at a Distance

Distance		Center Beam	Beam Width			
1.5ft	0.46m	222fc	0.8ft	0.24m	0.8ft	0.24m
3.0ft	0.91m	56fc	1.6ft	0.49m	1.6ft	0.49m
4.5ft	1.37m	24fc	2.4ft	0.73m	2.4ft	0.73m
6.0ft	1.83m	14fc	3.2ft	0.98m	3.2ft	0.98m
7.5ft	2.29m	8.7fc	3.9ft	1.19m	3.9ft	1.19m
9.0ft	2.74m	6.2fc	4.7ft	1.43m	4.7ft	1.43m
12ft	3.66m	5.6fc	6.3ft	1.92m	6.3ft	1.92m
15ft	4.57m	2.3fc	7.9ft	2.41m	7.9ft	2.41m
18ft	5.49m	1.6fc	9.5ft	2.90m	9.5ft	2.90m

Delivered Lumen: 164 lm
 ■ Vertical Beam Spread: 30.2°
 ■ Horizontal Beam Spread: 29.8°

8W, 3000K, 90+ CRI, Clear Lens

Polar Candela Distribution

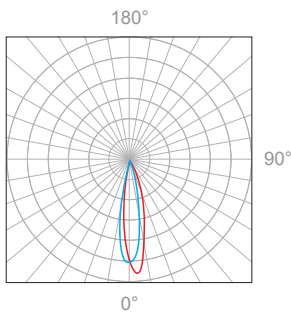

Beam Width: 12°



Illuminance at a Distance

Distance		Center Beam	Beam Width			
1.5ft	0.46m	2400fc	0.5ft	0.15m	0.5ft	0.15m
3.0ft	0.91m	600fc	1.0ft	0.30m	1.0ft	0.30m
4.5ft	1.37m	260fc	1.5ft	0.46m	1.5ft	0.46m
6.0ft	1.83m	147fc	2.0ft	0.61m	2.0ft	0.61m
7.5ft	2.29m	93fc	2.5ft	0.76m	2.5ft	0.76m
9.0ft	2.74m	65fc	3.1ft	0.94m	3.1ft	0.94m
12ft	3.66m	36fc	4.1ft	1.25m	4.1ft	1.25m
15ft	4.57m	23fc	5.1ft	1.55m	5.1ft	1.55m
18ft	5.49m	16fc	6.1ft	1.86m	6.1ft	1.86m

Delivered Lumen: 246.4 lm
 ■ Vertical Beam Spread: 16.5°
 ■ Horizontal Beam Spread: 15.7°

Polar Candela Distribution

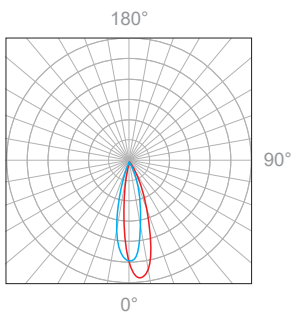

Beam Width: 30°



Illuminance at a Distance

Distance		Center Beam	Beam Width			
1.5ft	0.46m	429fc	0.8ft	0.24m	0.8ft	0.24m
3.0ft	0.91m	101fc	1.6ft	0.49m	1.6ft	0.49m
4.5ft	1.37m	44fc	2.4ft	0.73m	2.4ft	0.73m
6.0ft	1.83m	25fc	3.2ft	0.98m	3.2ft	0.98m
7.5ft	2.29m	15fc	3.9ft	1.19m	3.9ft	1.19m
9.0ft	2.74m	11fc	4.7ft	1.43m	4.7ft	1.43m
12ft	3.66m	6.3fc	6.3ft	1.92m	6.3ft	1.92m
15ft	4.57m	4.1fc	7.9ft	2.41m	7.9ft	2.41m
18ft	5.49m	2.9fc	9.5ft	2.90m	9.5ft	2.90m

Delivered Lumen: 288.8 lm
 ■ Vertical Beam Spread: 30.2°
 ■ Horizontal Beam Spread: 29.8°

Appendix

Stainless Steel Finish

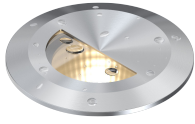

S6 stainless steel 316

Accessories

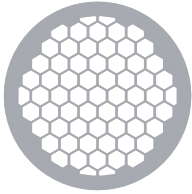

HM2 hex louver, matte clear anodized

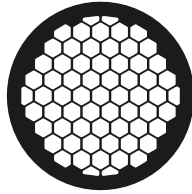

HB2 hex louver, black anodized



AB2 angled louver, black anodized

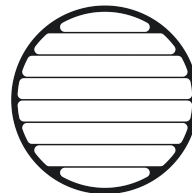

SB2 straight louver, black anodized

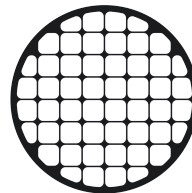

QB2 square louver, black anodized

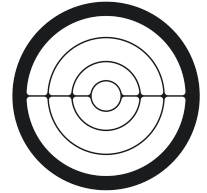

RB2 ring louver, black anodized

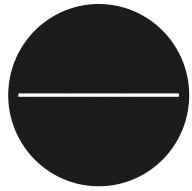

NB2 narrow beam louver, black