

DIMENSIONAL DATA (see page 4 for additional details)

Simple Slope 2

All Ori tiles have a drop of 5.00" at their deepest point

Simple Slope 2
Plenum/Chicago Plenum

Profiles

Simple Slope 1 (SS1)	Simple Slope 2 (SS2)	Plain (PLN)
Dynamic Slope 1 (DS1)	Dynamic Slope 2 (DS2)	Peak (PK1)
Valley 1 (VY1)	Valley 2 (VY2)	
Plateau 1 (PT1)	Plateau 2 (PT2)	

FEATURES

2x2 sound absorbing tiles available in ten design variations to add dimension to the ceiling plane.

Cut and folded, not thermoformed, to yield crisp, defined edges.

Noise Reduction Coefficient (NRC) average of 1.1, varies for each design. Refer to ASTM C423 test reports for more information.

Wide range of color options provides design flexibility and personalization for any project.

Plenum option meets construction requirements for CCEA (Chicago Plenum) marking, 2015 IMC 602.2 & 2018 NFPA 90A.

Available with The Naturals, a series of finishes that exude biophilic beauty.

ACOUSTIC PERFORMANCE*

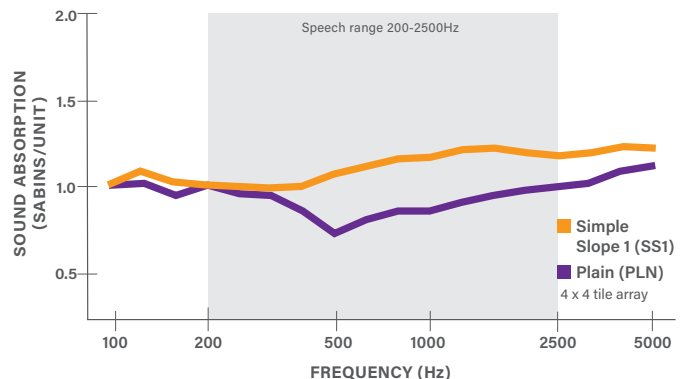

*Standard tile only. Plenum results will vary.

fixture:

project:

SPECIFICATIONS

Acoustic Material

Content	Housing material is 100% polyester containing up to 50% of recycled plastic bottles (PET felt) with an ASTM E-84 Class A / CAN ULC S102 fire rating and is moisture resistant. See page 3 for color offering. Acoustic material colors are subject to change without notice. For the most current color options, please visit www.focalpointlights.com/acousticsolutions . Lead times may vary depending on color.
Cleaning and Care	Remove dust and debris with a clean, soft, lint-free cloth or vacuum
PET Thickness	9mm

Acoustic Performance

Acoustic testing is performed on all Focal Point acoustic products and varies based on installation and configuration. ASTM C423 test reports can be downloaded from focalpointlights.com. Contact acoustic.solutions@focalpointlights.com for technical questions.

NRC	Noise Reduction Coefficient (NRC) is the average of how absorptive a material is at various frequencies within the human speech frequency range. Two materials with the same rating may not perform the same in application. Typically, an NRC of 0 indicates perfect reflection, and an NRC of 1 is designated as perfect absorption. However, based on the testing methodology and depending upon the material's shape or surface area products can test at an NRC greater than 1. Average NRC = 11, varies for each design
------------	--

Weight

Individual tiles will not exceed 5lbs. Plenum/Chicago Plenum tiles will not exceed 8lbs.

Assembly & Installation

Ships assembled for quick and easy installation; simply drop in grid ceiling structure.











Reliability

At Focal Point, our products are designed to stand the test of time. Each product is engineered using superior components, manufactured with the utmost care and rigorously tested.

Warranty

1-year limited warranty.

ORDERING

Series		AUO
Ori acoustic tile		AUO
Nominal Size		22
2' x 2'		22
<small>(consult factory for custom sizes)</small>		
Profile		
	Simple Slope 1	SS1
	Simple Slope 2	SS2
	Dynamic Slope 1	DS1
	Dynamic Slope 2	DS2
	Valley 1	VY1
	Valley 2	VY2
	Plateau 1	PT1
	Plateau 2	PT2
	Peak 1	PK1
	Plain	PLN
Mounting		
<small>(Ceiling grid by others)</small>		
15/16" Layin		G1
9/16" Layin		G2
Factory Options		
Plenum / Chicago Plenum		CP
<small>(Contact factory for Flush tile)</small>		
Color		
See page 3 for color offering		

Acoustic Materials



THE NATURALS (25% SCALE)



STANDARD PET



PREMIUM PET

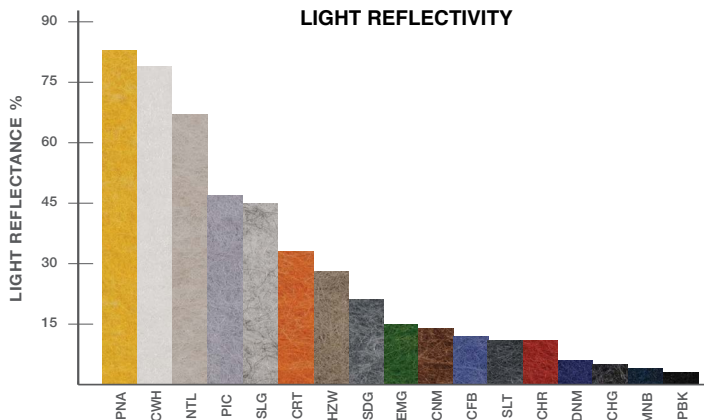

Declare.

9mm PET Felt
Focal Point, LLC

Final Assembly: Chicago, Illinois, USA
Life Expectancy: 30 Year(s)
End of Life Options: Salvageable/Reusable in its Entirety, Recyclable (100%)

Ingredients:

Polyethylene terephthalate: PET; **N, N'-Ethylene bisstearamide:** Octadecanamide, N,N'-1,2-ethanediybis-; **Stearic Acid:** Stearic Acid; **Antioxidant 1076:** Benzenepropanoic acid, 3,5-bis(1,1-dimethylethyl)-4-hydroxy-, octadecyl ester; **Antioxidant KY-405:** Benzenamine, 4-(1-methyl-1-phenylethyl) -N-[4-(1-methyl-1-phenylethyl)phenyl]; **Titanium Dioxide:** Titanium dioxide

Living Building Challenge Criteria: Compliant

I-13 Red List:

- LBC Red List Free
- LBC Red List Approved
- Declared

% Disclosed: 100% at 100ppm
VOC Content: Not Applicable

I-10 Interior Performance: CDPH Standard Method v1.1-2010
I-14 Responsible Sourcing: Not Applicable

FPL-0001
EXP. 01 MAR 2024
Original Issue Date: 2020

MANUFACTURERS RESPONSIBLE FOR LABEL AND BACK
INTERNATIONAL LIVING FUTURE INSTITUTE™ living-future.org/declare

PROFILE DETAILS

Simple Slope 1
(SS1)

Simple Slope 2
(SS2)

Dynamic Slope 1
(DS1)

Dynamic Slope 2
(DS2)

Valley 1
(VY1)

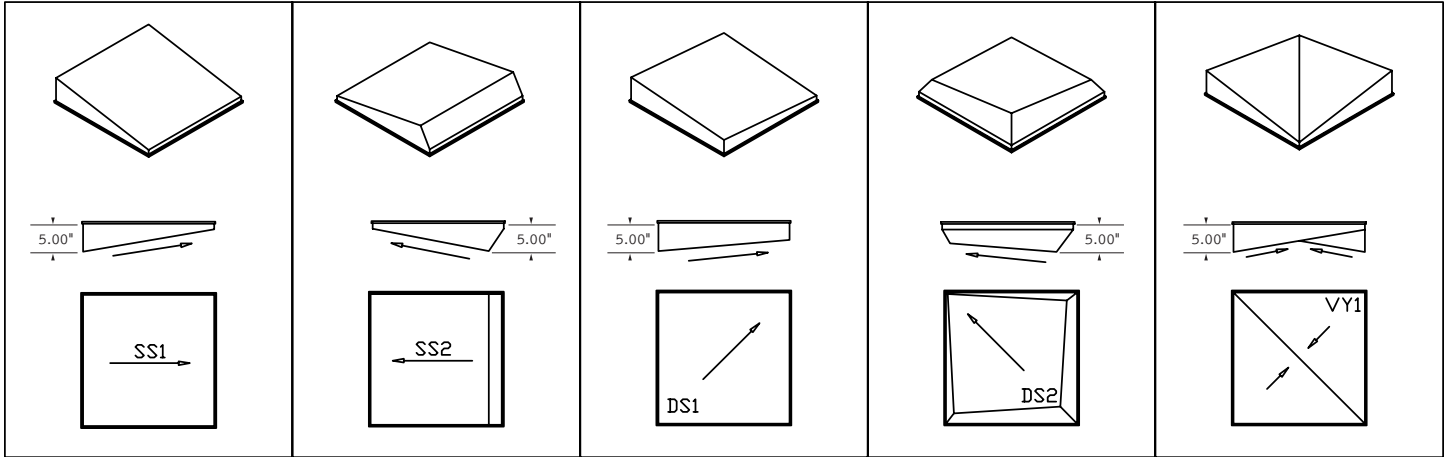

Valley 2
(VY2)

Plateau 1
(PT1)

Plateau 2
(PT2)

Peak
(PK1)

Plain
(PLN)

