

# Seem® 1

LED DIRECT WALL MOUNT

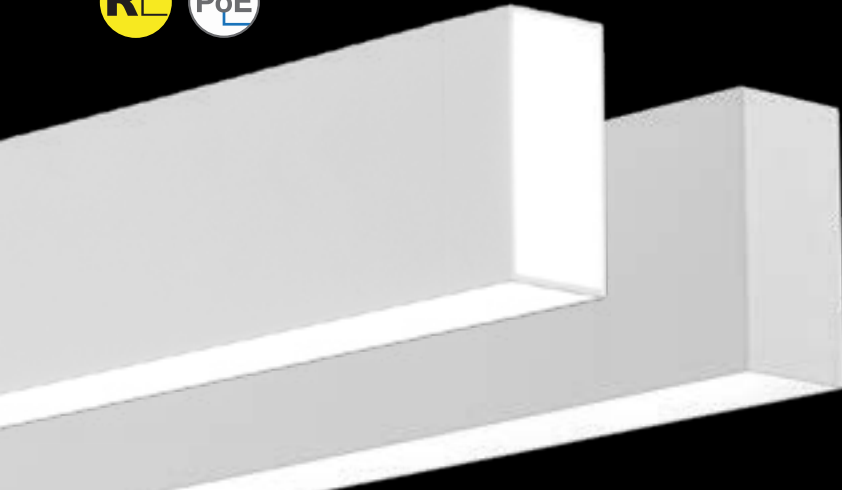

Pop-Down Lens



Corner detail

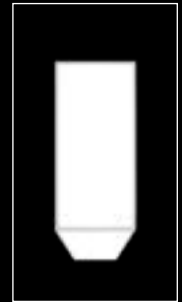

lit end cap detail



The Naturals collection - Chestnut shown

## DIMENSIONAL DATA

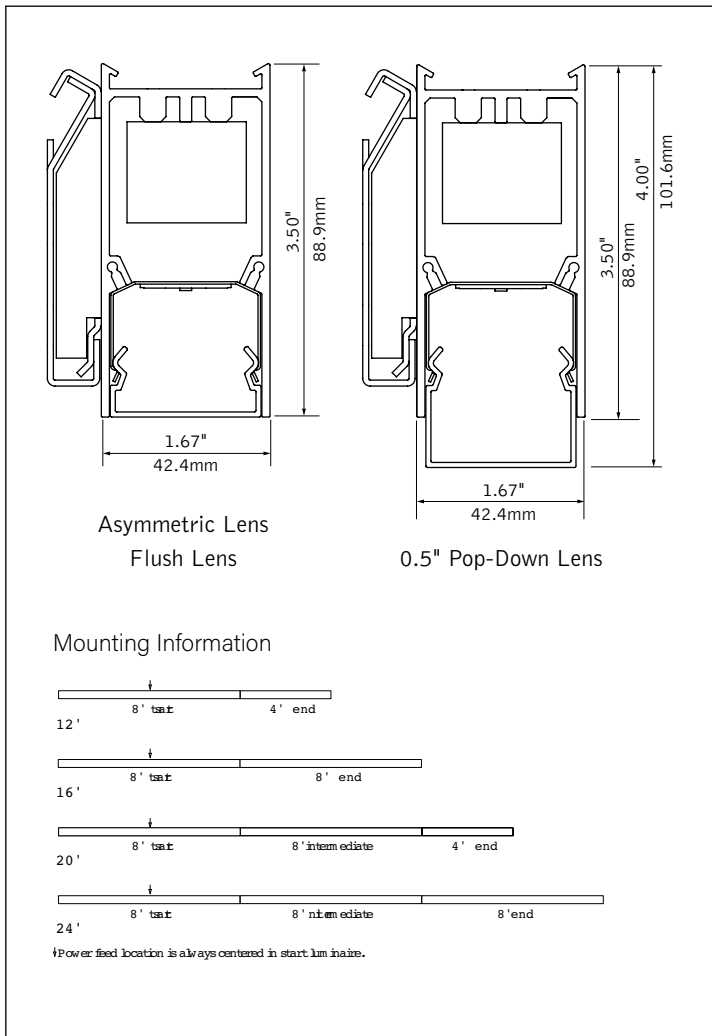

## FEATURES

Narrow extruded aluminum 1.5" linear direct wall mount LED with Asymmetric, Flush, and Pop-Down lens options.

Individual units and continuous runs in 1" increments.

Frosted acrylic lens provides uninterrupted illumination, without pixels or shadows.

LED position and lens material optimized to provide the perfect blend of high performance and visual comfort.

Choice of output levels to meet a wide variety of application needs.

PoE compatible: Integrates with Power over Ethernet lighting systems via standard, low-voltage wires.

Available with The Naturals, a series of finishes that exude biophilic beauty.

## DISTRIBUTIONS

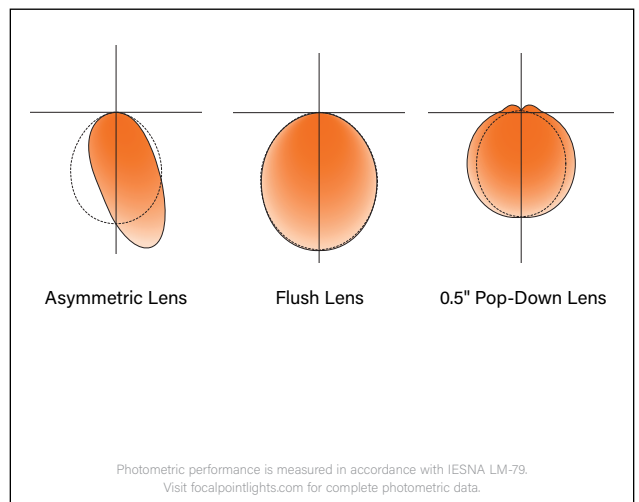

**DETAILS**

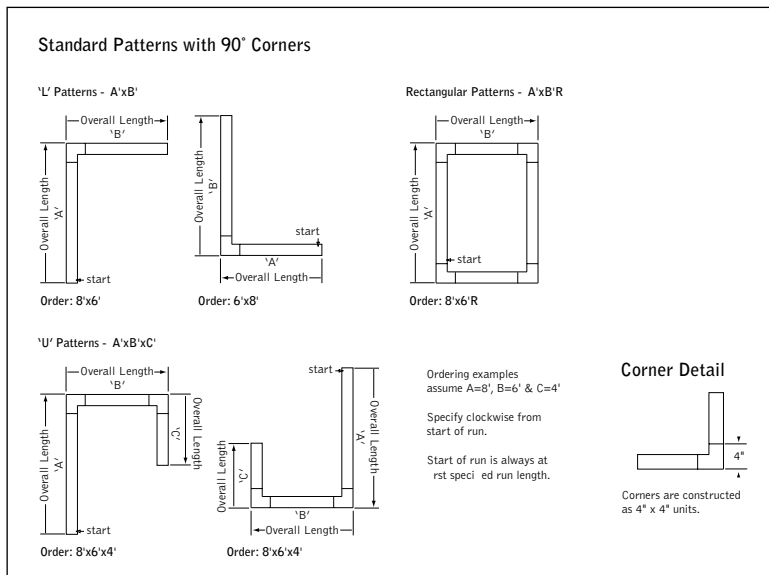

**SPECIFICATIONS**

**LED System**

Proprietary linear LED module incorporates premium LEDs on a robust platform to achieve excellent thermal management. LEDs are placed to promote a uniform appearance. Available in 3000K, 3500K or 4000K with both 80 and 90 CRI options. 3500K and 4000K with CRI>90 have a cyanosis observation index (COI) of 3.3 or less. LED modules and drivers are replaceable from below. Color accuracy <3 SDCM.

**Construction**

One piece extruded aluminum housing. Cast aluminum end caps. 8' unit weight: 15lbs.

**Optic**

Reflectors fabricated of 22 Ga. steel finished in High Reflectance White powder coat. Extruded acrylic lens .07" thick with frosted finish, up to 8' continuous.

**Electrical**

Luminaires are pre-wired with factory installed branch circuit wiring and over-molded quick connects. Standard 120-277V constant current driver includes 0-10V analog dimming. Power factor > .9. PoE compatible: Integrates with Power over Ethernet lighting systems via standard, low-voltage wires. PoE runs require an independent PoE node and power feed for each luminaire section.

**Emergency Battery**

Emergency output - 10 watts for 90 minutes.

**Labels**

UL and cUL listed. Suitable for Dry or Damp Locations, indoor use only.

**Finish**

Polyester powder coat applied over a multi-stage pre-treatment. The Naturals: 100% low VOC vinyl.

**Lumen Maintenance**

Reported: L70 at >61,000 hours      Calculated: L70 at 470,000 hours  
 L90 at >61,000 hours              L90 at 115,000 hours

Derived from EPA TM-21 calculator. Based on typical conditions, consult factory for additional data.

**Reliability**

At Focal Point, our products are designed to stand the test of time. Each luminaire is engineered using superior components, manufactured with the utmost care and rigorously tested. Contact us for reliability data.

**Warranty**

LED system rated for operation in ambient environments up to 25°C. 5-year limited warranty.



**PERFORMANCE CHARTS**

See page 3.

**ORDERING**

<b>Luminaire Series</b>	<b>FSM1W</b>
Seem 1 LED	FSM1W
<b>Shielding</b>	
Asymmetric Lens	AS
Flush Lens	FL
Pop-Down Lens	PD05
<b>Lumen Output</b>	
125 Lumens per foot <small>(4' minimum length. Consult factory for Lutron, DALI)</small>	125LF
250 Lumens per foot <small>(3' minimum length)</small>	250LF
375 Lumens per foot	375LF
500 Lumens per foot	500LF
625 Lumens per foot	625LF
<b>Color Temperature</b>	
3000K, 80CRI or 90 CRI	30K or 930K
3500K, 80CRI or 90 CRI	35K or 935K
4000K, 80CRI or 90 CRI	40K or 940K
<b>Circuits &amp; Zones</b>	
1 Circuit, non-emergency	1C
Consult Ordering Guide on page 4 for multiple circuiting and zoning options	_C_Z_DL
<b>Voltage</b>	
120/277 UNV Volt	UNV
347 Volt <small>(LD1 driver only)</small>	347
Low Voltage	LV
<b>Control System &amp; Dimming Level</b>	
0-10V - 10% Dimming	LD1
0-10V - 1% Dimming	L11
Low Voltage, PoE compatible <small>(No driver. Not available with EM or EC. LV Voltage only.)</small>	LVN
Lutron Hi-Lume EcoSystem (LDE1) - 1% Dimming	LH1
DALI 1% Dimming	D11
<b>Mounting</b>	<b>WM</b>
Wall Mount	WM
<b>Factory Options</b> <small>(See Ordering Guide on page 4 for ordering details for DC, EC, EM &amp; ECD.)</small>	
Lit End Caps <small>(Pair, adds 2" to overall luminaire length. FL shielding only. Not available with P35K.)</small>	LE
Daylight Circuit	_DC
Emergency Circuit	_EC
Emergency Battery Pack†	_EM
Emergency Control Device† <small>†(4' minimum length. 120/277 Volt only.)</small>	_ECD
<b>Finish</b> <small>(See finishes page for The Naturals options)</small>	
Black	BK
Titanium Silver	TS
Matte White Housing	WH
<b>Luminaire Length</b>	<b>ft in</b>
Specify luminaire/row length in 1" increments	_ft_in
<small>(2' minimum. Leave blank for patterns. Smaller increments available, consult factory.)</small>	
<b>Pattern Options</b> <small>(3' minimum length)</small>	
'L' pattern	A' x B'
'U' pattern	A' x B' x C'
Rectangular pattern <small>(Consult factory for other pattern options)</small>	A' x B' R

#### 4' PERFORMANCE CHART

Lumen Output	Delivered Lumens	Tested System Watts	Lumens Per Watt (LPW)		
			 AS	 FL	 PD05
125LF	500	6	82	75	76
250LF	1000	10	105	98	99
375LF	1500	15	110	104	105
500LF	2000	19	114	106	107
625LF	2500	24	110	103	100

Based on 3500K, 4' length. Lumen multipliers: Preferred Light = 0.65, 90 CRI = 0.87.  
Delivered lumens may vary +/- 5%. Actual wattage may vary +/- 5%

#### LIT END CAP PERFORMANCE CHART

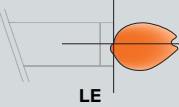
Lumen Output	Delivered Lumens Per End Cap	Tested System Watts Per End Cap	Lumens Per Watt (LPW)
			 LE
125LF	55	0.6	91
250LF	115	1.0	110
375LF	172	1.5	116
500LF	229	1.9	119
625LF	291	2.5	116

Based on 3500K. Lumen multipliers: 90 CRI = 0.87. Delivered lumens may vary +/- 5%. Actual wattage may vary +/- 5%.  
Tested System Watts is not incremental, but the portion of overall wattage consumed by the Lit End Cap module

# Finishes



## STANDARD FINISHES



WHITE WH BLACK BK TITANIUM SILVER TS

## THE NATURALS (25% SCALE)



LIGHT OAK LOK GRAY ELM GRE CHESTNUT CHT WALNUT WLT WOVEN LINEN WLN

# Ordering Guide



Direct Only Linear Circuitry, Zones & Factory Options

## HOW TO USE THIS GUIDE

Fill out the worksheet on the following page to specify your requirements for circuitry, zones, and factory options.

Refer to the run chart for standard run configurations, consult factory for custom configurations.

Complete the Totals / Ordering Codes at the bottom of the worksheet and add to your ordering logic on the cut sheet.

Submit the worksheet along with your order.

TOTAL RUN LENGTH: <u>32ft</u>		JOB NAME: _____			FIXTURE TYPE: _____			
HOUSING SECTION	SECTION LENGTH	SHARED ELECTRICAL FEED, NORMAL POWER			FACTORY OPTIONS			
		SWITCHING CIRCUIT	DIMMING ZONE	DAYLIGHT ZONE	SEPARATE ELECTRICAL FEEDS			EM
					DAYLIGHT CIRCUIT	EMERGENCY CIRCUIT	ECD	
1	8	1C	1Z					1EM
2	8	2C	2Z					
3	8	2C	2Z					
4	8				1DC			
<b>Totals / Ordering Codes</b>		<b>2C</b>	<b>2Z</b>		<b>1DC</b>			<b>1EM</b>

ORDERING: FSM4L-FL-625LF-35K- **2C2Z** -UNV-LD1-G2- **1DC-1EM** -WH-32ft

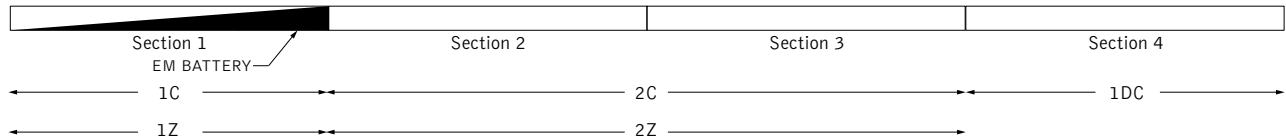

KEY	
<b>C = Switching Circuit</b> Switched Hot / Shared Neutral	<b>DC = Daylight Circuit</b> Switched Hot / Separate Neutral
<b>Z = Dimming Zone</b> Dimming Control Wires	<b>EC = Emergency Circuit</b> Switched Hot / Separate Neutral
<b>DL = Daylight Zone</b> Daylight Dimming Control Wires	<b>EM = Emergency Battery</b> Unswitched Hot / Shared Neutral
	<b>ECD = Emergency Control Device</b> Unswitched Hot / Separate Neutral

## DEFAULTS

- Zones and Factory Options illuminate entire sections from 4' to 8' in length.
- One shared or isolated circuit and zone required per housing section.
- Limit of one EM or ECD per housing section.
- Additional electrical feed required for applications greater than three shared circuits and zones.
- Each DC, EC and ECD require an additional electrical feed.
- ECD not available in the same housing section as EC.
- Longer lead times and additional pricing may apply for custom run configurations.

## CUSTOM LENGTHS

- If partial illumination of emergency or daylight section is required, indicate in ordering guide and add "partial illumination" in Order Notes. Drawing required.
- Engineering validation required, longer lead times may apply.

# Ordering Guide Worksheet

Linear Circuitry, Zones & Factory Options



TOTAL RUN LENGTH: _____		JOB NAME: _____			FIXTURE TYPE: _____			
HOUSING SECTION	SECTION LENGTH	SHARED ELECTRICAL FEED, NORMAL POWER			FACTORY OPTIONS			EM
		SWITCHING CIRCUIT	DIMMING ZONE	DAYLIGHT ZONE	SEPARATE ELECTRICAL FEEDS			
DAYLIGHT CIRCUIT	EMERGENCY CIRCUIT				ECD			
1								
2								
3								
4								
5								
6								
7								
8								
9								
10								
11								
12								
13								
14								
15								
16								
17								
18								
19								
20								
<b>Totals / Ordering Codes</b>								

WORKSHEET

Combine to create Circuits & Zones ordering code

Enter as individual Factory Options

## RUN CHART

Run length (ft)	Housing Configuration Section Lengths	Run length (ft)	Housing Configuration Section Lengths	Run length (ft)	Housing Configuration Section Lengths	Run length (ft)	Housing Configuration Section Lengths
9	5 + 4	21	8 + 8 + 5	33	8 + 8 + 8 + 5 + 4	45	8 + 8 + 8 + 8 + 8 + 5
10	6 + 4	22	8 + 8 + 6	34	8 + 8 + 8 + 6 + 4	46	8 + 8 + 8 + 8 + 8 + 6
11	7 + 4	23	8 + 8 + 7	35	8 + 8 + 8 + 7 + 4	47	8 + 8 + 8 + 8 + 8 + 7
12	8 + 4	24	8 + 8 + 8	36	8 + 8 + 8 + 8 + 4	48	8 + 8 + 8 + 8 + 8 + 8
13	8 + 5	25	8 + 8 + 5 + 4	37	8 + 8 + 8 + 8 + 5		
14	8 + 6	26	8 + 8 + 6 + 4	38	8 + 8 + 8 + 8 + 6		
15	8 + 7	27	8 + 8 + 7 + 4	39	8 + 8 + 8 + 8 + 7		
16	8 + 8	28	8 + 8 + 8 + 4	40	8 + 8 + 8 + 8 + 8		
17	8 + 5 + 4	29	8 + 8 + 8 + 5	41	8 + 8 + 8 + 8 + 5 + 4		
18	8 + 6 + 4	30	8 + 8 + 8 + 6	42	8 + 8 + 8 + 8 + 6 + 4		
19	8 + 7 + 4	31	8 + 8 + 8 + 7	43	8 + 8 + 8 + 8 + 7 + 4		
20	8 + 8 + 4	32	8 + 8 + 8 + 8	44	8 + 8 + 8 + 8 + 8 + 4		

Standard run configurations, consult factory for custom configurations.