

LP CIRCLE SEMI RECESSED

Project name:

Project type:

Notes:

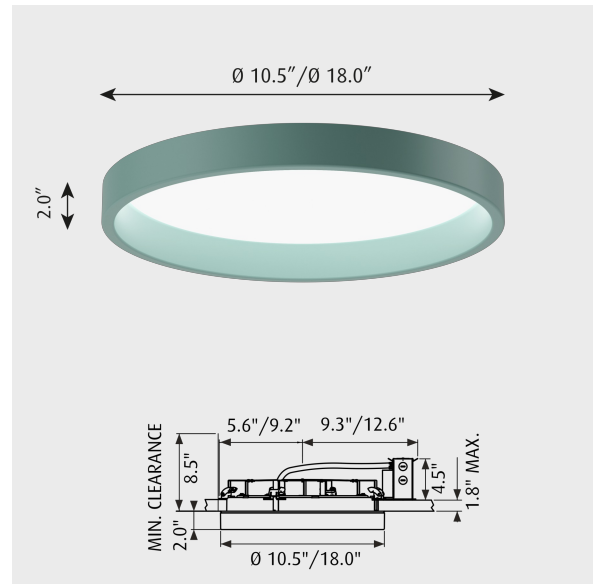

Design

Mikkel Beedholm/KHR Architecture

Product description

Designed by Mikkel Beedholm of KHR Architecture the LP Circle Series is available in 2 sizes, 4 standard colors and 4 mounting options. Originally designed for the Orestad Elementary School in Copenhagen, the LP Circle provides light and character. The ring is intentionally voluminous to have a presence in the room.

Available in 10.5" and 18" diameters; standard colors are white, black, pale petroleum and yellow; four mounting styles are recessed, semi-recessed, surface, and suspended. The substantial inner sides of the ring are tapered to increase the sense of depth and to enhance the gradient of the reflected light. The lens is uniformly illuminated with custom designed LED board using mid-power LEDs. Due to its larger surface area the fixture has low glare and superior wide distribution. It works well at washing an adjacent wall and in a lower or ceiling height area.

The recessed and semi-recessed versions are easily installed using the toolless cam locks; while the suspended version is easily installed by using only one mounting point. A very slight shadow ring is used to separate the edge of the fixture with the mounted surface. This allows for the edge to slightly float and to allow for any imperfections in the ceiling to be less noticeable.

Variant options

Dimension	Color	Light source	Lumen	Voltage frequency	Lighting control
10.5 IN	● Black	-	1065	120-277V/60HZ	Dali kelvin adjustable
18 IN	● Pale petroleum	LED 3000K 17W	1082		Dim 0-10v
	○ White	LED 3000K 30W	1126		
	● Yellow	LED 3500K 17W	1144		
		LED 3500K 30W	1233		
		LED 4000K 17W	1252		
		LED 4000K 30W	1334		
			1356		
			1377		
			2341		
			2378		
			2432		
			2471		
			2577		
			2618		
			2706		
			2750		
			2793		

Specification notes

a. Ø 10.5 IN available only in 17W. b. Ø 18 IN available only in 30W.

Light description

Very wide, 100% downward light distribution from the flat diffusing lens. Careful design of LED positioning and modern diffusing materials maximize light transmission while eliminating hot spots and glare. The inner wall of the aluminum ring reflects light for a gentle transition from dark to light regions. Standard CCT in 3000K, 3500K or 4000K, controlled by electronic driver.

Mounting

Mounting frame comprises of a crossbar assembled with a black polycarbonate shadow ring. The shadow ring allows for slight imperfections in the ceiling by allowing the ring to float very slightly below the ceiling. Ceiling cutout: 9.8" or 17.1" diameter. Junction box allows pass through wiring and has knock-outs for 1/2" trade size conduit. Adjustable tabs lock onto the top surface of the ceiling and lock into position with finger press. Junction box is connected to one of the tabs. Finishing Section is a replaceable electrical assembly including LED board, housing, and electronic, constant current LED driver for 120-277V operation and 0-10V dimming control. Finishing Section connects to Rough-in Section with a 5-pole tool-less quick connector and can be removed through the ceiling cutout. The Finishing Section attaches to the cross-bar frame with a twist-lock mechanism using four steel spring tabs. The diffuser has integral tabs for snap-fit into the housing. LED board is easily replaceable without removing luminaire from ceiling.

Information

Electrical:
System Wattage: 17W or 30W
LED Wattage: 16 W or 28 W
Delivered lumens: 1,020 - 2,424
Efficacy: 60.0 lm/W - 80.8 lm/W
Certifications:
cULus, Damp Location
Protection class IP20
Controllability: 0-10V Dimming
Color Rendering: Ra>90

Other functions

Alternative finishes. LED in 2700K, 4000K and 5000K . Alternative dimming controls. Tunable white system.

Specification notes

- a. Ø 10.5 IN available only in 17W.
- b. Ø 18 IN available only in 30W.
- c. 4000K Light Source available only with white finish.
- d. Tunable white available only with white finish.

Light distribution diagrams

For the full data set on all variants, see louispoulsen.com.

Cartesian

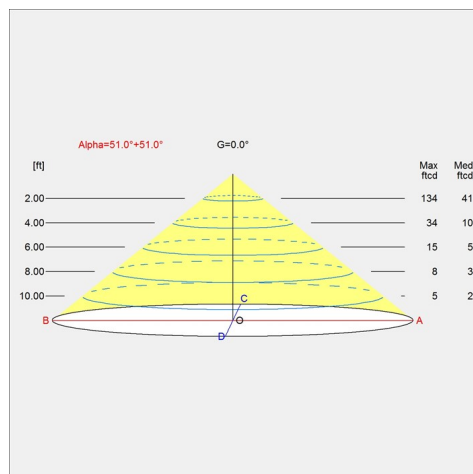

Isolux

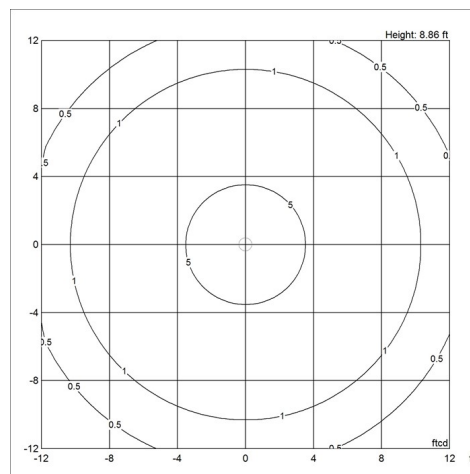

Polar

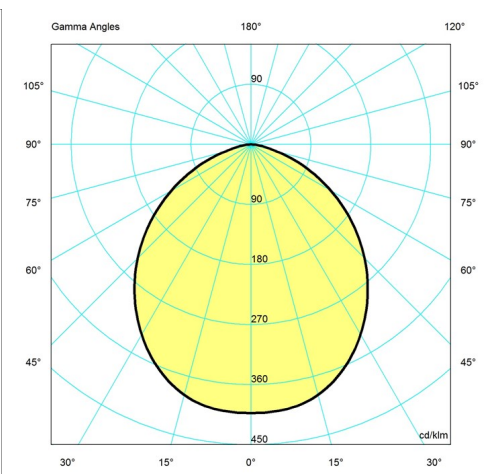

Material

Housing is deep drawn 0.06 IN aluminium. Mounting brackets are 0.06 IN thick aluminum. Diffuser is white acrylic formulated for high light transmission and diffusion. Materials are UV resistant to prevent fading. Internal reflective panel are white MC-PET polycarbonate, 0.03 IN thick. Standard finish are matte surface powder coat with minimum 2 mils thickness in black, white, pale petroleum or yellow.

Weight

Min: 11.001 lbs Max: 6.7 lbs

Dimensions

10.5 IN, 18 IN





















Finish

Black, Pale petroleum, White, Yellow

Voltage

120-277V/60HZ

Variant options

Dimension	Color	Light source	Lumen	Voltage frequency	Lighting control	Variant number
18 IN	 Pale petroleum	LED 3500K 30W	2471	120-277V/60HZ	Dim 0-10v	10000140490
10.5 IN	 Black	LED 3000K 17W	1065	120-277V/60HZ	Dim 0-10v	10000139854
18 IN	 Black	LED 3000K 30W	2341	120-277V/60HZ	Dim 0-10v	10000139856
18 IN	 Black	LED 3500K 30W	2378	120-277V/60HZ	Dim 0-10v	10000140482
18 IN	 Yellow	LED 3000K 30W	2577	120-277V/60HZ	Dim 0-10v	10000140484
18 IN	 Yellow	LED 3500K 30W	2618	120-277V/60HZ	Dim 0-10v	10000140486
18 IN	 Pale petroleum	LED 3000K 30W	2432	120-277V/60HZ	Dim 0-10v	10000140488
18 IN	 White	LED 3000K 30W	2706	120-277V/60HZ	Dim 0-10v	10000140492
18 IN	 White	LED 3500K 30W	2750	120-277V/60HZ	Dim 0-10v	10000140494
18 IN	 White	LED 4000K 30W	2793	120-277V/60HZ	Dim 0-10v	10000140496
10.5 IN	 Black	LED 3500K 17W	1082	120-277V/60HZ	Dim 0-10v	10000140498
10.5 IN	 Yellow	LED 3000K 17W	1233	120-277V/60HZ	Dim 0-10v	10000140500
10.5 IN	 Yellow	LED 3500K 17W	1252	120-277V/60HZ	Dim 0-10v	10000140502
10.5 IN	 Pale petroleum	LED 3000K 17W	1126	120-277V/60HZ	Dim 0-10v	10000140504
10.5 IN	 Pale petroleum	LED 3500K 17W	1144	120-277V/60HZ	Dim 0-10v	10000140506
10.5 IN	 White	LED 3000K 17W	1334	120-277V/60HZ	Dim 0-10v	10000140508
10.5 IN	 White	LED 3500K 17W	1356	120-277V/60HZ	Dim 0-10v	10000140510
10.5 IN	 White	LED 4000K 17W	1377	120-277V/60HZ	Dim 0-10v	10000140512
10.5 IN	 White	-	1334	120-277V/60HZ	Dali kelvin adjustable	10000150262
18 IN	 White	-	2706	120-277V/60HZ	Dali kelvin adjustable	10000150263