

Odyssey Line Voltage Flexible Track System

120V Fixtures

Specifications/Features

Odyssey line voltage flexible track system offers unique visual interest over standard ceiling track. Fixtures are crafted from high quality materials to provide years of appealing illumination with an adapter integrated into each one to ensure a solid electrical connection and simplified installation on the track. Fixtures are available in a silver or antique bronze finish to create a modern style

in many different environments. No transformer is required for the line voltage fixture offering. All fixtures carry ConTech's one year full replacement guarantee after installation. See specific fixtures for lamp type and maximum wattage, lamps are sold separately. All fixtures are cCSAus Certified for dry locations.

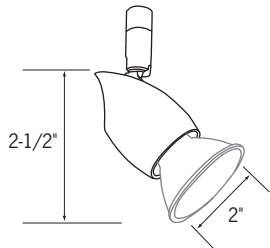

Neat Spot

Lamp: 50W max. PAR16 GU10 base
Finish: -AB, -S



LIR298

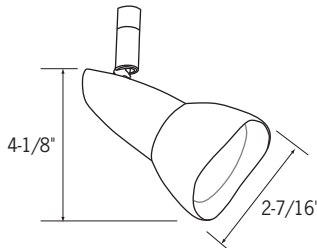

Ponti with Porcelain Shade

Lamp: 50W max. PAR16, GU10 base
Finish: -AB, -S



LIR400

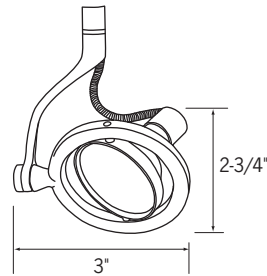

Lika Spot

Dual Swivel lampholder. Rear lampholder allows use of (1) LF16 series lens or FA-16 filter.
Lamp: 50W max. PAR16 GU10 base
Finish: -AB, -S



LIR596

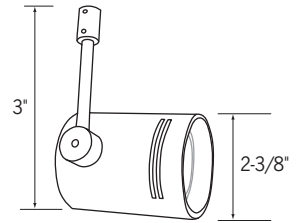

Bima Spot

Lamp: 50W max. PAR16 GU10 base
Finish: -AB, -S



LIR697

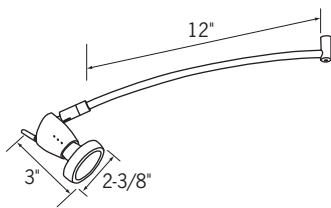

Risa Display Light with Ring

12" arm swivels to move spot fixture to either side of track.
Lamp: 50W max., PAR16, GU10 base
Finish: -S



LIR984

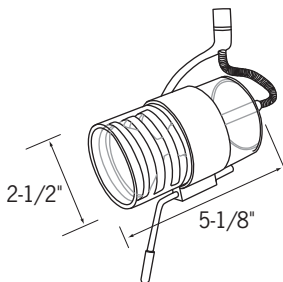

Varre

Glass tube accent with curved arm and removable side louver.
Lamp: 50W max. PAR16, GU10 base
Finish: -S



LIR1065

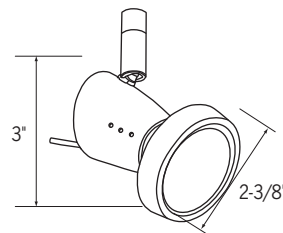

Risa with Ring

Lamp: 50W max. PAR16, GU10 base
Finish: -AB, -S



LIR4537

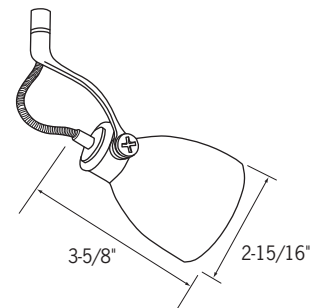

Radia-S with Porcelain Shade

Lamp: 40W max. T4, G9 Bi-pin base
Finish: -S



LIR44156

Odyssey Line Voltage Flexible Track System

120V Fixtures

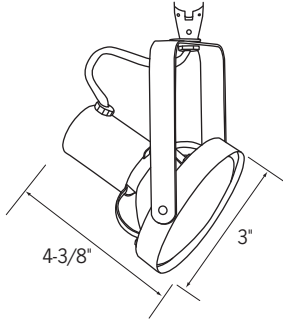

PAR20
Gimbal Mounted Spot

Front loading lamp. "Sure-Set" yoke.
 Lamp: 50W max. PAR20,
 E26 med. base
 Finish: -AB, -S



LIR2820

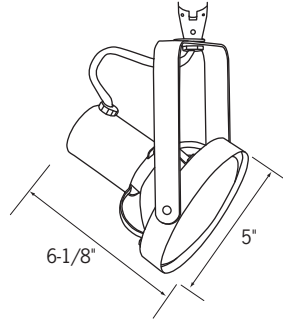

PAR38
Gimbal Mounted Spot

Front loading lamp. "Sure-Set" yoke.
 Lamp: 250W max. PAR38 or
 12W max. PAR38LED,
 E26 med. base
 Finish: -AB, -S

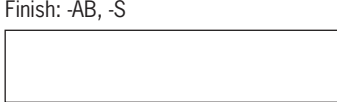

LIR2838

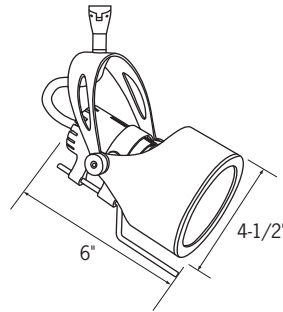

Bolos

Accepts LF20 series filters.
 Lamp: 75W max. PAR30,
 E26 med. base
 Finish: -AB, -S



LIR830

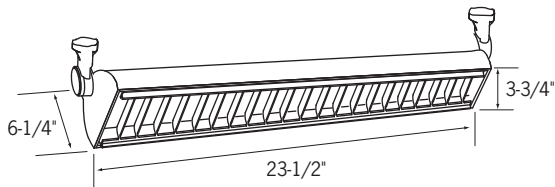

2' 2T5HO Wall Lighter

Fluorescent fixture. "Sure-Set" swivel positioning. High efficiency electronic ballast. 25-7/8" Overall length, 4" deep with louver.
 Lamp: (2) 24W T5HO, Mini Bi-Pin base
 Finish: -AB, -S



LIR14224/HO