

RF4A1

4" Adjustable LED Retrofit Trim Module

Specifications/Features

Trim Module

4" Adjustable LED retrofit modules for use in new construction / remodeling retrofit light commercial and residential applications. Compatible with most 4" recessed downlights. Retrofit module comes standard with a specular clear reflector, providing a 28° beam distribution and is easily field interchangeable. Additional accessory reflectors are available in 15°, 40° and 55° beam distributions. Pull-down trim with fully adjustable mechanism, provides 355° rotation and 65° tilt. Aluminum die-cast heat sink is designed to facilitate heat dissipation to ensure consistent quality light output, color and life of solid state components.

Lamp/Electrical

Light engine consist of a single, high output multi-chip LED array enabling precise optical control.
 12W, 900 Delivered Lumens
 Standard color temperature options include 2700K, 3000K, 3500K and 4000K with CRI 90+
 Integrated driver for 120VAC input, TRIAC/ELV Dimming
 LED Connector type: IDEAL Model 182 Female connector (#30-682F)
 System designed and rated for 50,000 hours at 70% lumen maintenance.

Warranty

This complete fixture is covered by ConTech's full five (5) year replacement guarantee after date of purchase.

Listing

ETL Listed or ETL Classified based upon housing compatibility (U.S. and Canada).
 Suitable for use in damp locations.

**DISCONTINUED ITEM:
LIMITED INVENTORY**
 Consult Factory for Availability

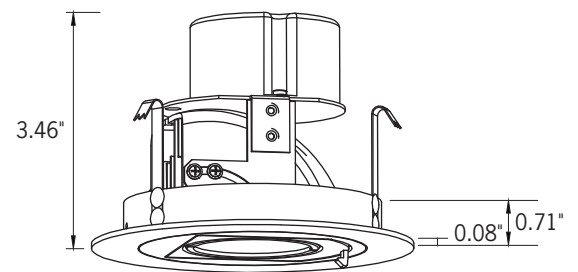

Ceiling Cut-Out: Ø4"

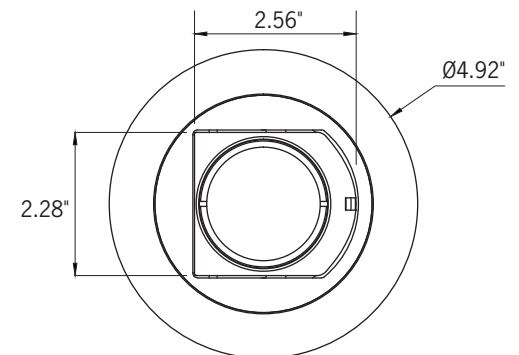

Ordering Information

Example Order:

Trim Module	Reflector	Color Temp	CRI	Base Adapter	Finish
<input type="text" value="RF4A1"/>	<input type="text" value="N - 28°"/>	<input type="text" value="27K - 2700K
30K - 3000K
35K - 3500K
40K - 4000K"/>	<input type="text" value="C - 90 CRI"/>	<input type="text" value="E - E26 Base"/>	<input type="text" value="WHT - White
BLK - Black
SC - Satin Chrome"/>

Accessories

- RF4A1REFL-15** - 15° Reflector
- RF4A1REFL-28** - 28° Reflector
- RF4A1REFL-40** - 40° Reflector
- RF4A1REFL-55** - 55° Reflector (Includes 40° Reflector plus Diffuser)
- RF4A1-HONEYCOMB** - Honeycomb Louver

RF4A1

4" Adjustable LED Retrofit Trim Module

Photometrics

RF4A1N30KCE-WHT

Designed for 50,000 Hour Lamp Life¹; LM-63 Test No. G17062205

Light Output (Fixture Delivered Lumens): 895
 Total Watts@120V: 11W
 Lumens Per Watt: 81.4
 Color Rendering Index (CRI)²: 92
 Color Temperature (CCT)³: 2929K
 Spectral Power Distribution Chart⁴

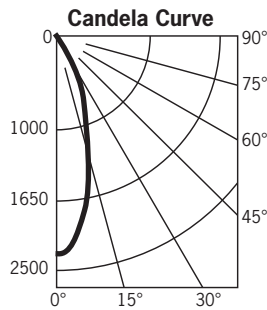
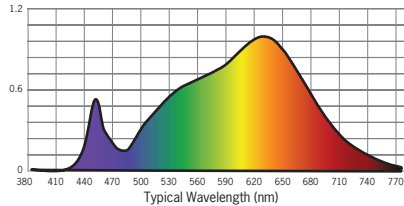

Candlepower Summary

FROM 0	CANDELA	LUMENS
0	2309	
5	2158	220
15	1222	346
25	574	266
35	92	58
45	12	10
55	8	8
65	6	6
75	5	5
85	3	1
95	0	

Intensity Distribution

DISTANCE (FT.)	FOOTCANDLES (FC)	BEAM DIAMETER (FT.)
4'	144.3	2.3
6'	64.1	3.4
8'	36.1	4.5
10'	23.1	5.6
12'	16.0	6.8
14'	11.8	7.9

Beam Distribution: 31°
 Spacing Criteria: 0.56

RF4A1N30KCE-WHT + RF4A1REFL-15

Designed for 50,000 Hour Lamp Life¹; LM-63 Test No. G17062301

Light Output (Fixture Delivered Lumens): 870
 Total Watts@120V: 11W
 Lumens Per Watt: 79.1
 Color Rendering Index (CRI)²: 92
 Color Temperature (CCT)³: 2929K
 Spectral Power Distribution Chart⁴

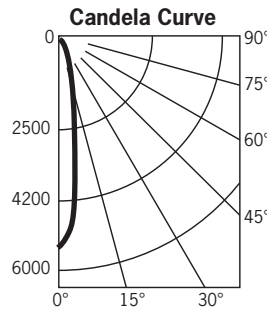
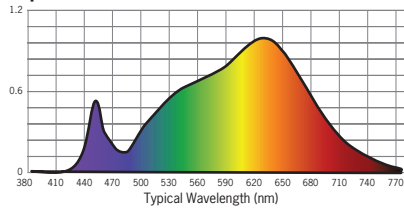

Candlepower Summary

FROM 0	CANDELA	LUMENS
0	5461	
5	4144	428
15	1032	292
25	410	190
35	45	29
45	10	8
55	8	8
65	10	10
75	6	6
85	3	2
95	0	

Intensity Distribution

DISTANCE (FT.)	FOOTCANDLES (FC)	BEAM DIAMETER (FT.)
4'	341.3	1.1
6'	151.7	1.7
8'	85.3	2.2
10'	54.6	2.8
12'	37.9	3.4
14'	27.9	3.9

Beam Distribution: 16°
 Spacing Criteria: 0.31

RF4A1N30KCE-WHT + RF4A1REFL-40

Designed for 50,000 Hour Lamp Life¹; LM-63 Test No. G17062302

Light Output (Fixture Delivered Lumens): 891
 Total Watts@120V: 11W
 Lumens Per Watt: 81
 Color Rendering Index (CRI)²: 92
 Color Temperature (CCT)³: 2929K
 Spectral Power Distribution Chart⁴

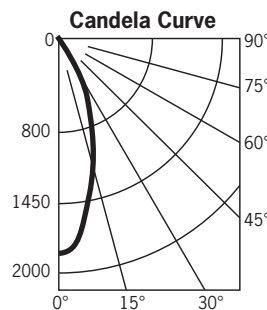
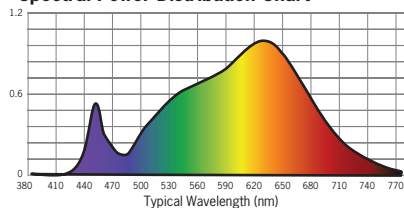

Candlepower Summary

FROM 0	CANDELA	LUMENS
0	1815	
5	1737	177
15	1159	329
25	614	284
35	122	77
45	19	15
55	12	11
65	7	7
75	5	5
85	3	2
95	0	

Intensity Distribution

DISTANCE (FT.)	FOOTCANDLES (FC)	BEAM DIAMETER (FT.)
4'	113.4	2.8
6'	50.4	4.2
8'	28.4	5.6
10'	18.1	6.9
12'	12.6	8.3
14'	9.3	9.7

Beam Distribution: 38°
 Spacing Criteria: 0.66

RF4A1N30KCE-WHT + RF4A1REFL-55

Designed for 50,000 Hour Lamp Life¹; LM-63 Test No. G17062303

Light Output (Fixture Delivered Lumens): 787
 Total Watts@120V: 11W
 Lumens Per Watt: 71.5
 Color Rendering Index (CRI)²: 92
 Color Temperature (CCT)³: 2929K
 Spectral Power Distribution Chart⁴

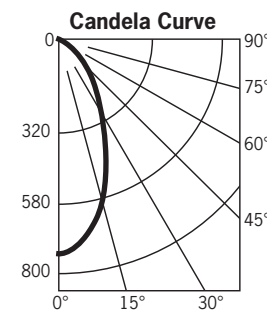
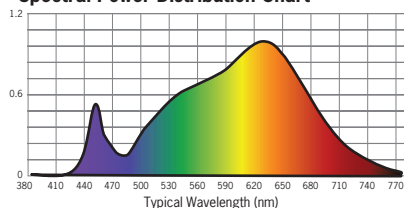

Candlepower Summary

FROM 0	CANDELA	LUMENS
0	738	
5	718	73
15	577	163
25	384	178
35	224	140
45	126	97
55	74	67
65	46	46
75	25	27
85	5	3
95	0	

Intensity Distribution

DISTANCE (FT.)	FOOTCANDLES (FC)	BEAM DIAMETER (FT.)
4'	46.1	3.9
6'	20.5	5.8
8'	11.5	7.7
10'	7.4	9.7
12'	5.1	11.6
14'	3.8	13.5

Beam Distribution: 52°
 Spacing Criteria: 0.83

1. Dependent on surrounding temperatures; 2. Accuracy of rendering colors; 3. Color appearance of light source; 4. Colors present within the light source