

100 Square Angled Gimbal 22 LED Specifications

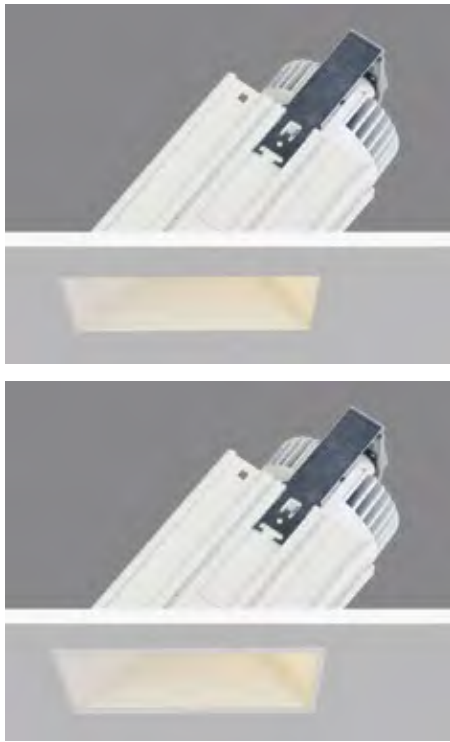

Ordering Information

Model	LED ^{1,2}	Power ³	Beam Angle	Voltage	Power Supply ⁴	Diffuser	Options
WG-P100SAG22 plaster-in	80 CRI CB-827 CB-830 CB-835 CB-840	L M	30 40 80	UNV	S D010 D3W ⁵ DES ⁵	CD FR (80° Beam Only) MP OA	AS HL
WG-B100SAG22 bezel trim							
				120	DFPN ⁵		

Luminaire

- Bezel trim or trimless 'plaster-in' 4 x 4.4" Angled Gimbal (22.5° tilt) for drywall ceilings and tiles.
- Installation from below the ceiling for remodel or new construction.
- 'Easy click' tool free installation of die-cast aluminum LED insert.
- Die-cast aluminum trim housing with heavy gauge galvanized steel yoke.
- Removable driver box from below ceiling.
- Open aperture standard, other diffusers/options available (see diffusers/options).
- 30° tilt in all directions.
- Powder coat painted white - RAL 9010.

LED^{1,2}

80+ CRI (Low/Medium Power)

- CB-827 = 2700K, 1045/1233lm
- CB-830 = 3000K, 1045/1233lm
- CB-835 = 3500K, 1091/1311lm
- CB-840 = 4000K, 1091/1311lm
- For 90+ CRI specify, CB-927, CB-930, etc. Approximately 15% less lumens than 80 CRI.
- For 95+ CRI specify, CB-F927, CB-F930, etc. Approximately 30% less lumens than 80 CRI.

Power³

- L = Low Power, 6.8W @ 400mA
- M = Mid Power, 8.6W @ 500mA

Beam Angle

- 30 = 30° accent illumination
- 40 = 40° general illumination
- 80 = 80° general illumination

Voltage

- UNV = 120-277V
- 120 = 120V

Power Supply (integral)⁴

- S = Standard non-dim driver, 120-277V.
- D010 = EldoLED, 1%, 0-10V dimming, 120-277V.
- D3W = Lutron, 1%, 3-wire dimming, 120V-277V.
- DES = Lutron, 1%, EcoSystem E1/E2 digital dimming, 120-277V.⁵
- DFPN = Lutron 1% forward phase with neutral, 120V only.⁵

Diffuser (Open Aperture standard)

- CD = Clear Diffuser
- FR = Frosted Diffuser (80° Beam Only)
- MP = Micro Prismatic Diffuser
- OA = Open Aperture

Emergency

- Emergency LED driver available, order separately.

Options

- AS = Accessory Snoot
- HL = Hex Louver
- CP = Chicago Plenum Housing available, refer to specsheet.
- IC = Insulated Ceiling Housing available, refer to specsheet.
- NC = New Construction Plates available, consult factory.

¹ Other lumen packages available, consult factory.

² See LED data sheet for delivered lumens.

³ Wattage shown does not include power supplies/drivers. System wattage adds 10-20%.

⁴ See power supply page for details.

⁵ Consult factory for lead-times.

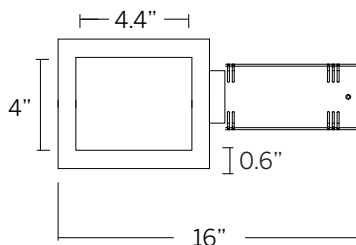
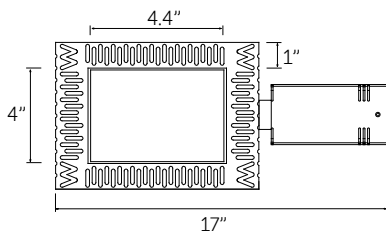
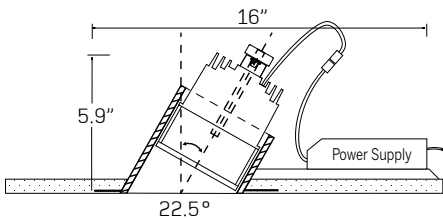

cut-out dimensions 4 5/8" x 5" rectangle

100 Square Angled Gimbal 22 LED

Dimensions

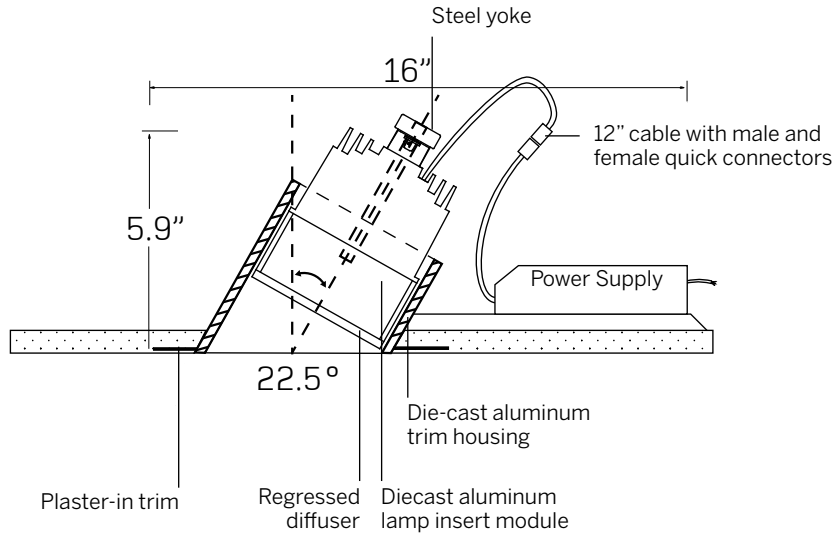

See power supply page for details.

Plaster-in instructions

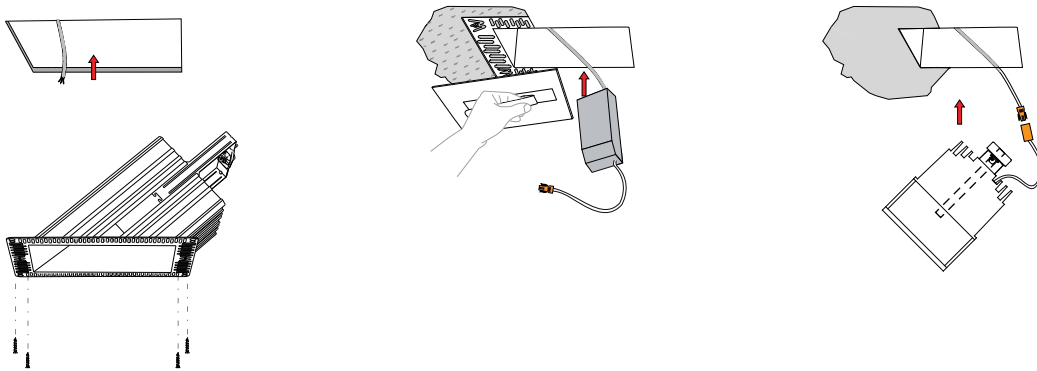

Bezel instructions

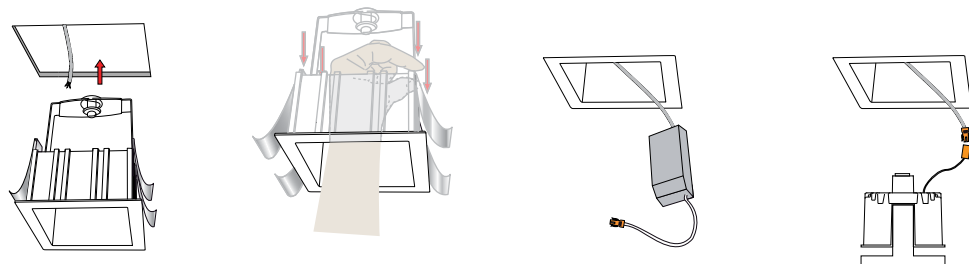

100 Square Angled Gimbal 22 LED Power Supplies

S (Standard non-dim)

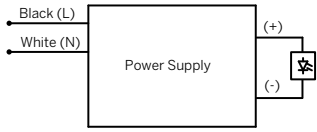

D010 (EldoLED 0-10V)

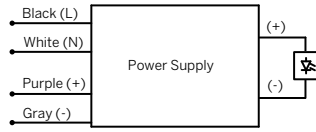

DFPN (1% Lutron forward phase with neutral)

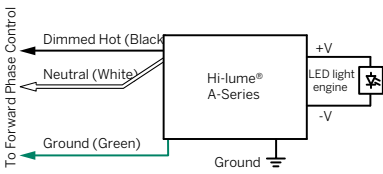

Note: Colors shown correspond to terminal blocks on driver.

DW3 (Lutron 1%, 3-wire)

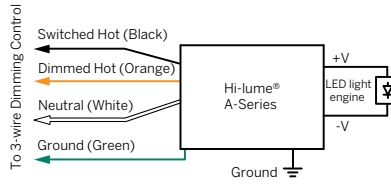

DES (Lutron 1% EcoSystem® digital)

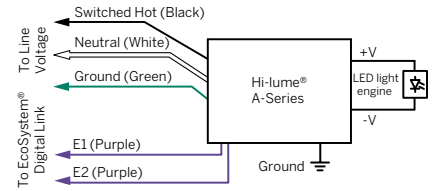

Note: Colors shown correspond to terminal blocks on driver.

Note: Colors shown correspond to terminal blocks on driver.