



PACE
ILLUMINATION

ROBUSTO

AESW - shaped wedge

STANDARD FEATURES

- Architectural shape wedge
- Heavy gauge formed aluminum construction
- Extruded aluminum lens doorframe
- Clear tempered glass lens standard
- Optional prismatic lens available
- High performance specular optical systems
- Optional yoke and bollard mounting available
- HPF ballast, magnetic for HID and low THD electronic for PL
- Suitable for up or downlight



Intertek

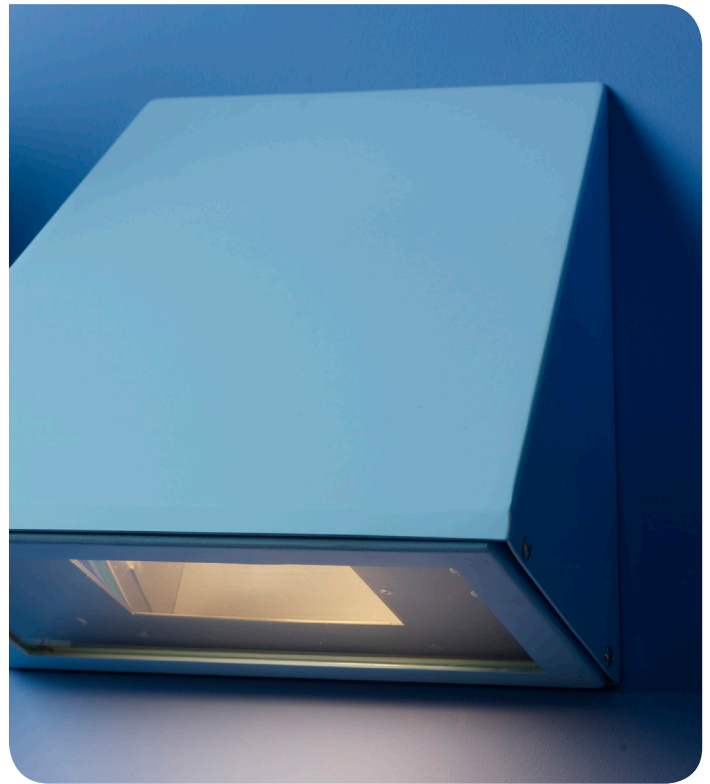

SERIES	MODEL	HEIGHT	LAMP	VOLT	OPTICS	LUMENS	CCT	CONTROL	COLOR	MOUNTING	OPTIONS
AESW	1620	S = SMALL	LED 16 Watt	120-277V UNV 347-408V UNV	TYPE I TYPE II TYPE III	2000	3500K 4000K 5000K	0-10 V DIMM	TAL = TEXTURED ALUMINUM TBK = TEXTURED BLACK TBZ = TEXTURED BRONZE TWH = TEXTURED WHITE	WMDL = WALL MOUNT DOWNLIGHT WMUL = WALL MOUNT UPLIGHT YM = YOKE MOUNT 2YM = 2 YOKE MOUNT BM/S = BOLLARD MOUNT SINGLE BM/D = BOLLARD MOUNT DOUBLE PM = POLE MOUNT	PHOTO CELL FACTORY INSTALLED PE1 = 120V PE2 = 277V MS = MOTION SENSOR EM = Emergency Backup BT = Bluetooth sensor RD = Remote dimming
			LED 35 Watt			4000					
	1640	L = LARGE									

ORDERING INFORMATION

SERIES	MODEL	HEIGHT	LAMP	VOLT	OPTICS	LUMENS	CCT	CONTROL	COLOR	MOUNTING	OPTIONS

Consult factory for voltage and other lamp options. Product specifications subject to change without notice.

1. Programmable drivers at the PACE factory
2. Color tunable
3. Capable of remote dimming
4. Can be equipped with motion sensors for on/off functioning
5. Can be equipped with light sensors for dusk-to-dawn automatic on/off operation
6. Bluetooth commissioning sensor capability for Android and iOS

Although PACE has prepared the information contained in this document with all due care, PACE does not warrant or represent that the information is free from errors or omission. Whilst the information is considered to be true and correct at the date of publication, changes in circumstances after the time of publication may impact on the accuracy of the information. The information may change without notice and PACE is not in any way liable for the accuracy of any information printed and stored or in any way interpreted or used.

In the interest of product improvement, Pace reserves the right to make technical and product specification changes without notice. Consult factory for voltage and other lamp options.



PACE
ILLUMINATION

ROBUSTO
AESW - shaped wedge

SIZE

Small = 12" x 21"
Large = 20" x 36"

MOUNTING

Wall Mount, bollard, yoke mount
See technical data sheets for other mounting

COLOR

Textured polyester powder coat finishes

WMDL = wall mount downlight

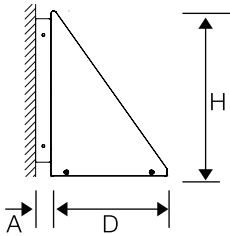

WMUL = wall mount uplight

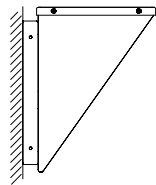

PM = Pole Mount

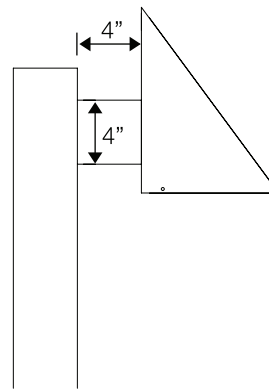

BM/S = bollard single

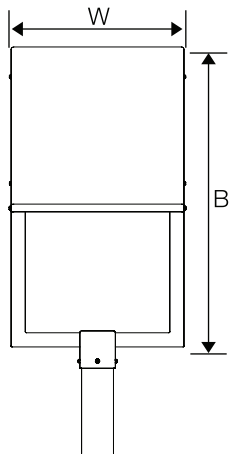
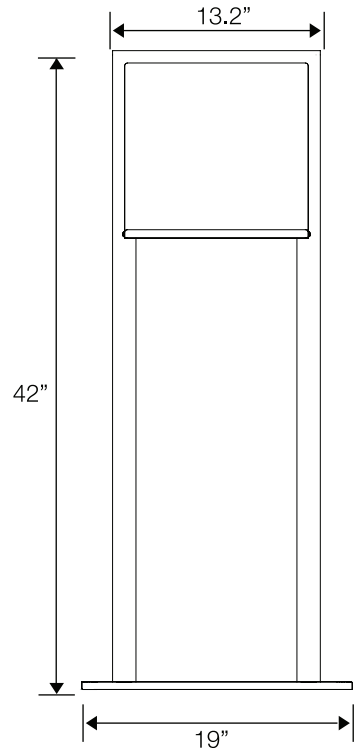

YM = yoke mount

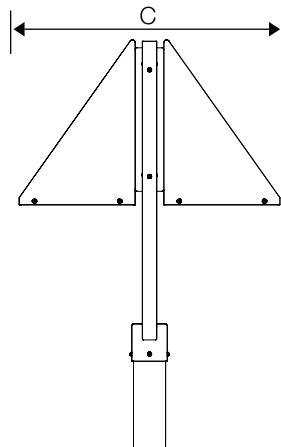

2YM = 2 yoke mount

Bollard base detail

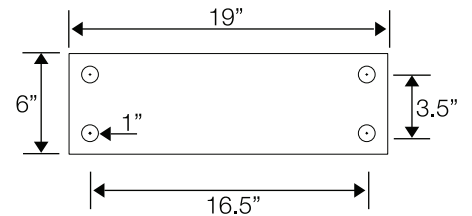

	W	H	D	A	B	C	EPA
Small	12"	12"	8"	1.0"	21.0"	18.3"	1.8
Large	20.0"	20.0"	14.2"	1.5"	36.0"	32.0"	2.3

Although PACE has prepared the information contained in this document with all due care, PACE does not warrant or represent that the information is free from errors or omission. Whilst the information is considered to be true and correct at the date of publication, changes in circumstances after the time of publication may impact on the accuracy of the information. The information may change without notice and PACE is not in any way liable for the accuracy of any information printed and stored or in any way interpreted or used.

In the interest of product improvement, Pace reserves the right to make technical and product specification changes without notice. Consult factory for voltage and other lamp options.