

Date: _____ Customer: _____

Project: _____

Type: _____ Qty: _____



The name alone – Cloud – evokes the poetic nature of these creations, which, according to their maker, should convey ‘the feeling of freedom and eccentricity’. The lamps are available in various sizes and models. Each lamp has a voluminous yet delicate paper-like shade, in the center of which is the invisible light source. With its irregular sculptural shape, marked by countless folds, crimps, bulges and dents, it suggests a fleecy Cloud and then again a large, soft snowball. Looked at more closely, the lampshade consists of several interlinked cup-like elements. Each lamp has an individual note in spite of all lamps having the same structure and the same predetermined shape. The idea is that the fold structure of the shade, which is shaped more or less by accident during production, can be changed by bulging it out or pressing it in. In doing so, Gehry makes users into co-designers who can repeatedly change the shape of the lamp if they so wish.

Construction

Luminaire

Made from flexible, tear-free, flame-resistant and aging resistant polyester material.

Tube

Stainless Steel, fine-grain finish

Base

White Aluminum

Mounting Option

- Table
- Standing
- Floor
- Pendant Light in various sizes

Classifications

- Ingress Protection – IP20
- Protection against contact with fingers and against foreign bodies
- No protection against water



Electrical Characteristics

LED Specification

Cree LED.

For Warm Dim, Tunable White and Full Color Tunable Options

Lumenetix Araya 5 LED module - 5 color chip array to stabilize coloring across full spectrum, with all 1640-8000K whites occurring fully on black body curve, maintaining 95CRI or better. Tight color consistency with Max 2 SSD. Available with XL Pendant Light Only.*

LED Life

L80 greater than 50,000 hours.

Correlated Color Temperature (CCT)

- Available in 3000K, 3500K, and 4000K. For Pendant XL Warm Dim range 1800K-3000K, tunable white range 1650K-8000K, and fully saturated color is available
- CRI 80+ 95+(pendant only)

Light Distribution

Diffuse

Dimming

Various dimming options available



Ordering Codes

KUBC-	TL-	10	DF -	27-	85 -	OnOff -
TYPE	TABLE LIGHT	SIZE	LIGHT DISTRIBUTION	CCT*	CRI	DIMMING
BC - Baby Cloud	TL - Table light LED	10 - 0-170mm / 6.7"	DF - diffuse	27 - 2700K	85 - 80+ min CRI	DO - OnOff

Ordering Example: **KUBC-TL-10-DF-27-85-DO**

KUCLD -	SL-	11 -	DF -	_____ -	80 -	_____ -
TYPE	STANDING LIGHT	HEIGHT	LIGHT DISTRIBUTION	CCT*	CRI	DIMMING
CLD - Cloud	SL - Standing light LED	11 - 1700mm / 6.7"	DF - diffuse	27 - 2700K 30 - 3000K 40 - 4000K	80 - 80+ min CRI	D1 - Triac Phase Dim (120v) D2 - -0-10V dim (10%) D3 - Lutron Hi-Lume dim to 1% (consult factory for 2-wire, 3-wire, or digital control) D4 - EldoLED 0% dim to dark

Ordering Example: **KUCLD-SL-11-DF-27-80-D2**

KUCLD -	TL-	12 -	DF -	_____ -	80 -	_____ -
TYPE	TABLE LIGHT	HEIGHT	LIGHT DISTRIBUTION	CCT*	CRI	DIMMING
CLD - Cloud	FL - Floor Light LED	12 - 520mm / 6.7"	DF - diffuse	27 - 2700K 30 - 3000K 40 - 4000K	80 - 80+ min CRI	D1 - Triac Phase Dim (120v) D2 - -0-10V dim (10%) D3 - Lutron Hi-Lume dim to 1% (consult factory for 2-wire, 3-wire, or digital control) D4 - EldoLED 0% dim to dark

Ordering Example: **KUCLD-FL-LED-12-DF-40-80-D1**

KUCLD -	PL-	_____ -	_____ -	_____ -	DF -	_____ -	_____ -	_____ -
TYPE	PENDANT LIGHT	LAMPING	HEIGHT	SUSPENSION HEIGHT	LIGHT DISTRIBUTION	CCT*	CRI	DIMMING
CLD - Cloud	PL - Pendant light	LED - LED FLU - Fluorescent	30 - H-480mm / 18.8" 32 - H-520mm / 20.4" 34 - H-600mm / 23.6" 36 - H-650mm / 25.5 XL - L -1500-1600mm / 58-63"	08 - Max 8ft 16 - Max 16ft	DF - diffuse	27* - 2700K 30* - 3000K 40* - 4000K WD* - warm dim TW* - Tunable white CT* - full color tunable	80 - 80+ min CRI 95 - 95+ CRI (for WD, TW, CT)	D1 - Triac Phase Dim (120v) D2 - -0-10V dim (10%) D3 - Lutron Hi-Lume dim to 1% (consult factory for 2-wire, 3-wire, or digital control) D4 - EldoLED 0% dim to dark

Ordering Example: **KUCLD-PL-LED-32-16-DF-TW-95-D2**

* LED Only



Technical

Baby Cloud - Table Lamp

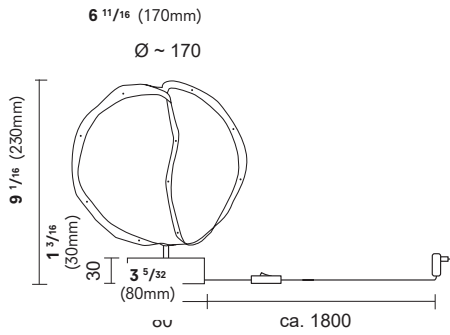

Cloud - Floor Lamp

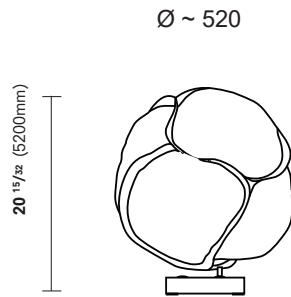

Cloud - Standing Lamp

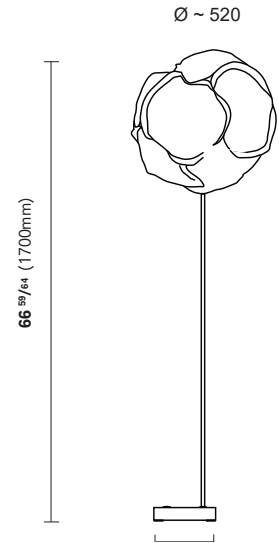

Cloud - Pendant Lamp

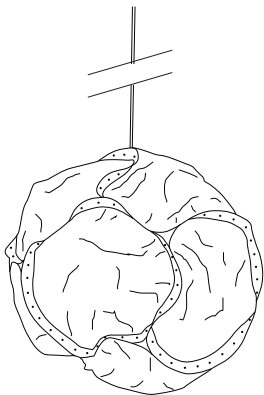

- 18 ⁵⁷/₆₄ (480mm)
 - 20 ¹⁵/₃₂ (520mm)
 - 23 ⁵/₈ (600mm)
 - 25 ¹⁹/₃₂ (650mm)
- Various size ranges

Cloud - XL Pendant Lamp

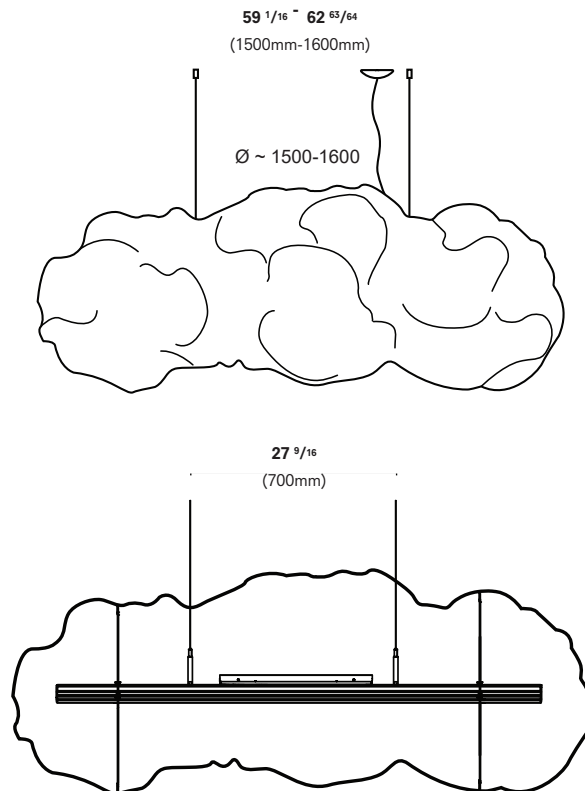

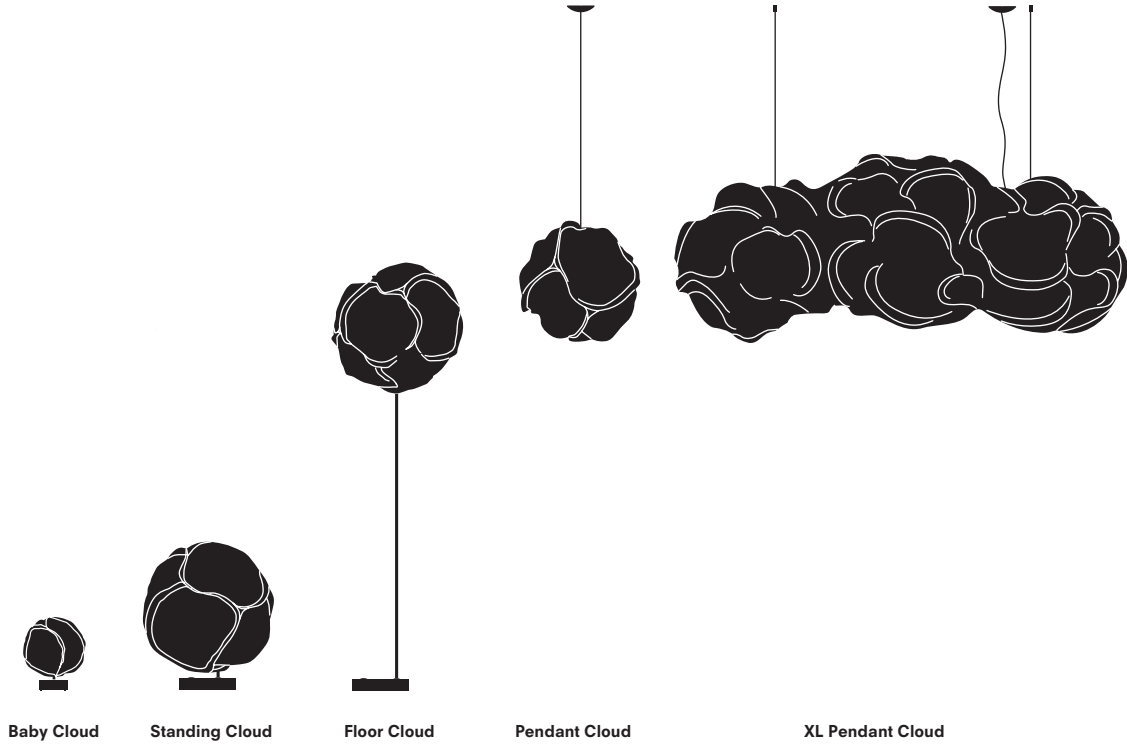

photometry — for full photometry, please reference IES files on www.kreon.com

KUCL-PE-32-40-80-D0-08

total luminous flux of luminaire: 4200 lm @ 4000 K

CCT:4000K

CRI:80+

power: 37W

Efficacy: 114 lm/W

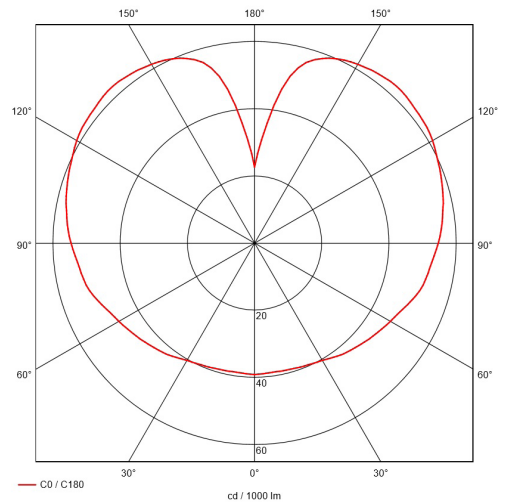

Mounting/Installation

1. Assemble your mounting hardware for Pendant



2. Start assembling your cloud - join all the pieces together

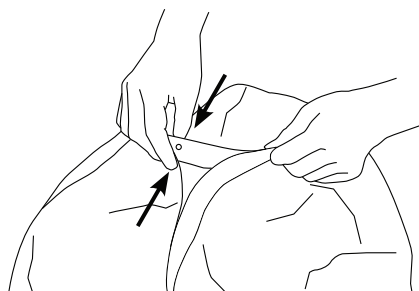

Click!

3. Place hand inside and 'fluff' your cloud.

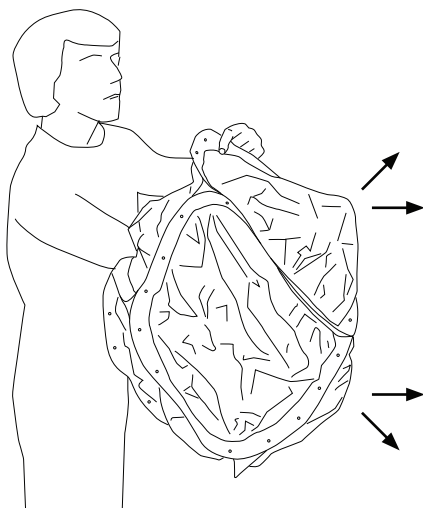

4. Place your cloud around your included light source. Test fixture.

