

ULH-10671

Lightsoft 15 Bollard

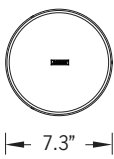

[Top] 27w LED 1188 Lumens
 [Accent Light] 12w LED 1080 Lumens
 IP65 • Suitable For Wet Locations
 IK08 • Impact Resistant (Vandal Resistant)
 Weight 23 lbs

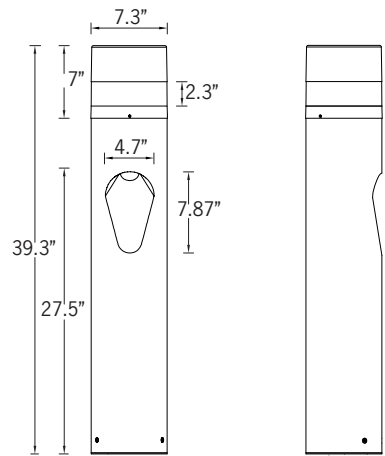

Top View

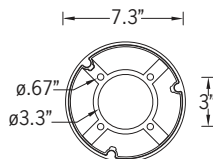

Mounting Detail

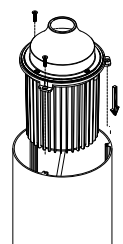

IP65 - Internal top access driver housing, prewired with SO cord and waterproof cable gland for easy installation.

Construction

Aluminum
 Less than 0.1% copper content - Marine Grade 6060 extruded & LM6 Aluminum High Pressure die casting provides excellent mechanical strength, clean detailed product lines and excellent heat dissipation.

Pre paint
 8 step degrease and phosphate process that includes deoxidizing and etching as well as a zinc and nickel phosphate process before product painting.

Memory Retentive -Silicon Gasket
 Provided with special injection molded "fit for purpose" long life high temperature memory retentive silicon gaskets. Maintains the gaskets exact profile and seal over years of use and compression.

Thermal management
 LM6 Aluminum is used for its excellent mechanical strength and thermal dissipation properties in low and high ambient temperatures. The superior thermal heat sink design by Ligman used in conjunction with the driver, controls thermals below critical temperature range to ensure maximum luminous flux output, as well as providing long LED service life and ensuring less than 10% lumen depreciation at 50,000 hours.

Surge Suppression
 Standard 10kv surge suppressor provided with all fixtures.

BUG Rating
 Contact Factory

Finishing
 All Ligman products go through an extensive finishing process that includes fettling to improve paint adherence.

Paint
 UV Stabilized 4.9Mil thick powder coat paint and baked at 200 Deg C. This process ensures that Ligman products can withstand harsh environments. Rated for use in natatoriums.

Hardware
 Provided Hardware is Marine grade 316 Stainless steel.

Anti Seize Screw Holes
 Tapped holes are infused with a special anti seize compound designed to prevent seizure of threaded connections, due to electrolysis from heat, corrosive atmospheres and moisture.

Crystal Clear Low Iron Glass Lens
 Provided with tempered, impact resistant crystal clear low iron glass ensuring no green glass tinge.

Optics & LED
 Precise optic design provides exceptional light control and precise distribution of light. LED CRI > 80

Lumen - Maintenance Life
 L80 /B10 at 50,000 hours (This means that at least 90% of the LED still achieve 80% of their original flux)

Indirect light-emitting bollard with integrated accent light.

The innovative reflector technology of the Lightsoft bollard guarantees a high degree of efficiency and optimal visual comfort. Lightsoft has been developed to have excellent controlled downward light providing wide spacing ratios. It has three light shield accessories with different light distributions. The Lightsoft is available in a cylindrical or square shape design with two different heights.

The Lightsoft Bollard comes standard with a unique waterproof internal driver housing compartment that is situated at the top of the pole to stop water and dust from entering the electrical components. This fixture is supplied completely wired with powercord and waterproof gland from the driver enclosure to the base of the bollard ensuring quick trouble-free installation. Custom bollard heights are available, please specify.

Color temperature 2700K, 3000K, 3500K and 4000K. Custom wattages can be provided to suit customer and Title 24 requirements. (Specify total watts per fixture)

All Ligman fixtures can be manufactured using a special pre-treatment and coating process that ensures the fixture can be installed in natatoriums as well as environments with high concentrations of chlorine or salt and still maintain the 5 year warranty. For this natatorium rated process please specify NAT in options.

This product is provided with an integrated 12w recessed accent light that can be used for providing low glare illumination and additional light on pathways, as well as providing backlight to accent foliage or landscape elements.

This 12w recessed accent light is available with narrow, medium and wide beam spreads.

Additional Options (Consult Factory For Pricing)



PROJECT	<input type="text"/>	DATE	<input type="text"/>
----------------	----------------------	-------------	----------------------

QUANTITY	<input type="text"/>	TYPE	<input type="text"/>	NOTE	<input type="text"/>
-----------------	----------------------	-------------	----------------------	-------------	----------------------

ORDERING EXAMPLE || ULH - 10671 - 27/12w - W - W30 - 02 - 120/277v - Options

OCCUPANCY SENSOR OPTIONS

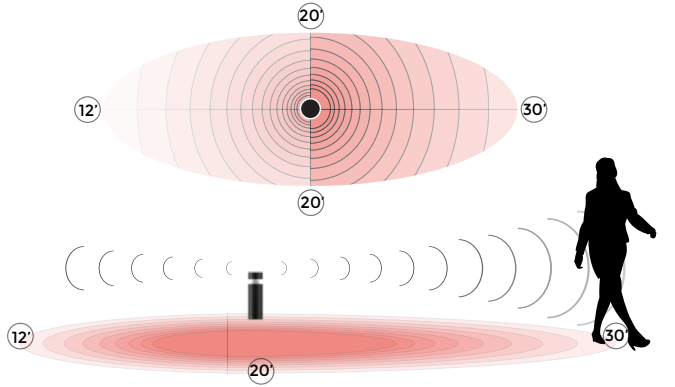

OCC1
SINGLE OCCUPANCY SENSOR DETECTION RANGE
[UNIVERSAL LEFT OR RIGHT DETECTION]

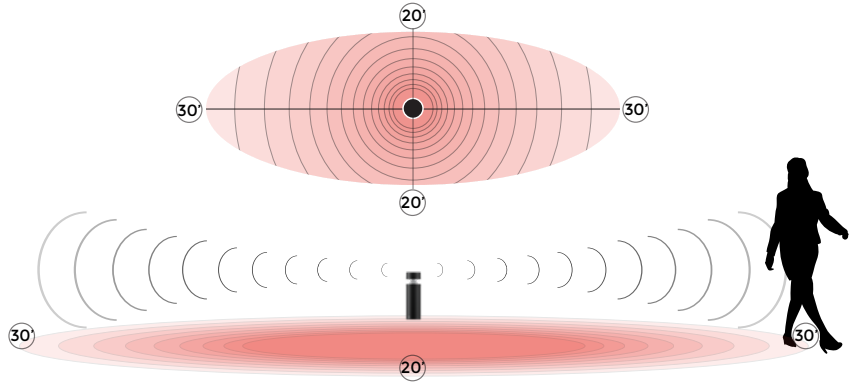

OCC2
DUAL OCCUPANCY SENSOR DETECTION RANGE

* The integrated, smart occupancy sensor can be programmed on site to function in a variety of ways.
Example: Simple on-off mode || DIM -> full light output on detection -> DIM | Off -> full bright on detection -> DIM for a set time with no detection -> off | DIM -> full bright on detection -> DIM

ULH-10671	<input type="text"/>	<input type="text"/>	<input type="text"/>	<input type="text"/>	<input type="text"/>
LAMP	BEAM	LED COLOR	FINISH COLOR	VOLTAGE	
[Top] 27w LED 1188 Lumens	ACCENT LIGHT BEAM N - Narrow 16° M - Medium 27° W - Wide 43°	W27 - 2700K W30 - 3000K W35 - 3500K W40 - 4000K	01 - BLACK RAL 9011 02 - DARK GREY RAL 7043 03 - WHITE RAL 9003 04 - METALLIC SILVER RAL 9006 05 - MATTE SILVER RAL 9006 06 - LIGMAN BRONZE 07 - CUSTOM RAL	120/277v Other - Specify	
[Accent Light] 12w LED 1080 Lumens					

<input type="text"/>	<input type="text"/>	<input type="text"/>
----------------------	----------------------	----------------------

ADDITIONAL OPTIONS

- A10731 - 180° Light Shield
- A10831 - 90° Light Shield
- GFCI - GFCI Box
- NAT - Natatorium Rated
- AMB - Turtle Friendly Amber LED
- A91591 - Lockable In Use GFCI Receptacle Outlet Box
- HGT - Custom Bollard Height [Specify HGT=XX"]
- DIM - 0-10v Dimming
- OCC1 - Single Occupancy Sensor
- OCC2 - Dual Occupancy Sensor

CITY OF FLAGSTAFF & TURTLE FRIENDLY COMPLIANT

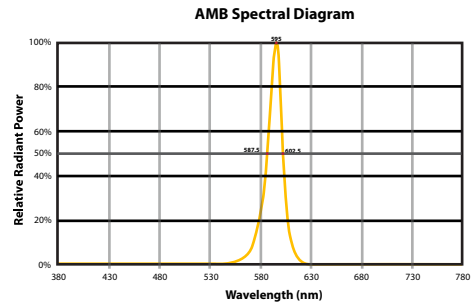

Narrow-Spectrum Amber LEDs
Peak wavelength between 585 & 595 nanometers and a full width of 50% power no greater than 15 nanometers.t



Bollard occupancy sensor settings

Please specify factory setting requirements

DIP Switch Settings (HC403VRC-KD)

1 Detection Range

Sensor sensitivity can be adjusted by selecting the combination on the DIP switches to fit precisely for each specific application.

	1	2	
<input type="checkbox"/> I	●	●	100%
<input type="checkbox"/> II	●	○	75%
<input type="checkbox"/> III	○	●	50%
<input type="checkbox"/> IV	○	○	10%

I – 100%
 II – 75%
 III – 50%
 IV – 10%

2 Hold-time

Select the dip switch configuration for the full brightness on-time after presence detection.

Please note that this function is disabled when the natural daylight exceeds the daylight threshold setting for more than 5 minutes.

	1	2	3	
<input type="checkbox"/> I	●	●	●	5s
<input type="checkbox"/> II	●	●	○	30s
<input type="checkbox"/> III	●	○	●	1min
<input type="checkbox"/> IV	●	○	○	5min
<input type="checkbox"/> V	○	●	●	10min
<input type="checkbox"/> VI	○	●	○	20min
<input type="checkbox"/> VII	○	○	○	30min

I – 5s
 II – 30s
 III – 1min
 IV – 5min
 V – 10min
 VI – 20min
 VII – 30min

3 Daylight Threshold

Set the level according to the fixture and environment. The light will not turn on if ambient lux level exceeds the daylight threshold preset.

Please note that the ambient lux level refers to internal light reaching the sensor.

Disabling the daylight sensor will put the sensor into occupancy detection only mode.

	1	2	
<input type="checkbox"/> I	●	●	Disable
<input type="checkbox"/> II	●	○	5.0fc
<input type="checkbox"/> III	○	●	1.0fc
<input type="checkbox"/> IV	○	○	0.2fc

I – Disable
 II – 5.0fc
 III – 1.0fc
 IV – 0.2fc

4 Stand-by period (corridor function)

This is the time period you would like to keep at the low light output level before it is completely switched off in the long absence of people.

Note: "0s" means on/off control;

"+ ∞" means the stand-by time is infinite and the fixture never switches off.

	1	2	3	
<input type="checkbox"/> I	●	●	●	0s
<input type="checkbox"/> II	●	●	○	10s
<input type="checkbox"/> III	●	○	●	1min
<input type="checkbox"/> IV	●	○	○	5min
<input type="checkbox"/> V	○	●	●	10min
<input type="checkbox"/> VI	○	●	○	30min
<input type="checkbox"/> VII	○	○	●	1H
<input type="checkbox"/> VIII	○	○	○	+∞

I – 0s
 II – 10s
 III – 1min
 IV – 5min
 V – 10min
 VI – 30min
 VII – 1H
 VIII – +∞

5 Stand-by dimming level

The setting is used to select the desired dimmed light level used in periods of absence for enhanced comfort and safety.

	1	2	
<input type="checkbox"/> I	●	●	10%
<input type="checkbox"/> II	●	○	20%
<input type="checkbox"/> III	○	●	30%
<input type="checkbox"/> IV	○	○	50%

I – 10%
 II – 20%
 III – 30%
 IV – 50%

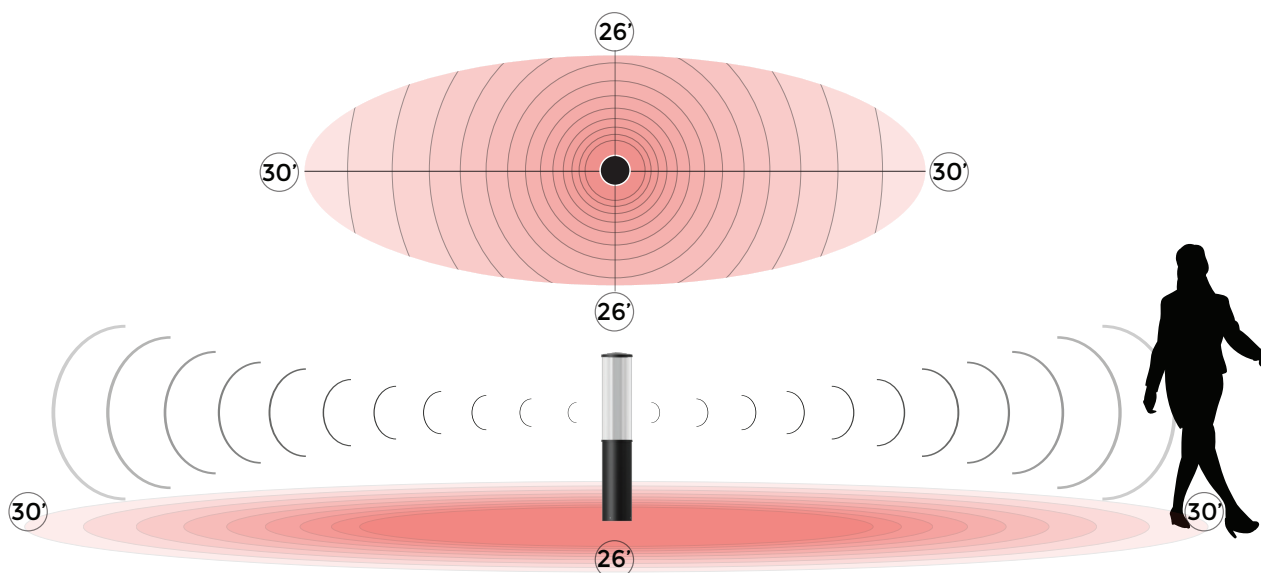

Lightsoft Product Family



Lightsoft 1 ϕ 7.3"

- ULH-10655-27w-1188lm [23.6"]
- ULH-10665-27w-1188lm [39.3"]



Lightsoft 2 - 7.3"x7.3"

- ULH-10675-27w-1050lm [23.6"]
- ULH-10685-27w-1050lm [39.3"]



Lightsoft 3 ϕ 4"

- ULH-10573-14w-447lm [23.6"]
- ULH-10583-14w-447lm [39.3"]



Lightsoft 4 - 4" x 4"

- ULH-10593-14w-346lm [23.6"]
- ULH-10603-14w-346lm [39.3"]



Lightsoft 5

- ULH-31146-14w-447lm



Lightsoft 6

- ULH-31156-14w-346lm



Lightsoft 15 ϕ 7.3"

- ULH-10671-27w/12w-2268/1025lm