

UJE-10572

Jet 57 Cylindrical Single Head Bollard

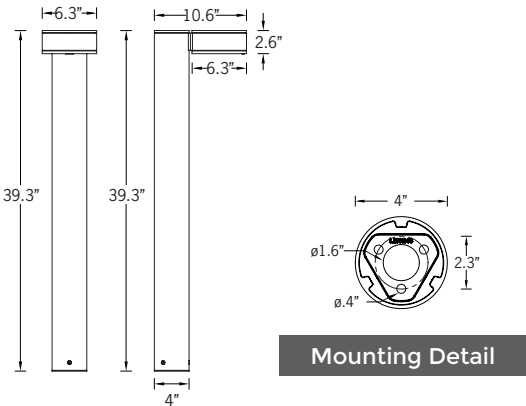

18w LED - 2135 Lumens
IP65 • Suitable For Wet Locations
IK08 • Impact Resistant (Vandal Resistant)
Weight 12 lbs



Construction

Aluminum

Less than 0.1% copper content - Marine Grade 6060 extruded & LM6 Aluminum High Pressure die casting provides excellent mechanical strength, clean detailed product lines and excellent heat dissipation.

Pre paint

8 step degrease and phosphate process that includes deoxidizing and etching as well as a zinc and nickel phosphate process before product painting.

Memory Retentive - Silicon Gasket

Provided with special injection molded "fit for purpose" long life high temperature memory retentive silicon gaskets. Maintains the gaskets exact profile and seal over years of use and compression.

Thermal management

LM6 Aluminum is used for its excellent mechanical strength and thermal dissipation properties in low and high ambient temperatures. The superior thermal heat sink design by Ligman used in conjunction with the driver, controls thermals below critical temperature range to ensure maximum luminous flux output, as well as providing long LED service life and ensuring less than 10% lumen depreciation at 50,000 hours.

Surge Suppression

Standard 10kv surge suppressor provided with all fixtures.

BUG Rating

B0 - U0 - G0

Finishing

All Ligman products go through an extensive finishing process that includes fettling to improve paint adherence.

Paint

UV Stabilized 4.9Mil thick powder coat paint and baked at 200 Deg C. This process ensures that Ligman products can withstand harsh environments. Rated for use in natatoriums.

Inspired by Nature Finishes

The Inspired by nature Finishing is a unique system of decorative powder coating. Our metal decoration process can easily transform the appearance of metal or aluminum product into a wood grain finish.

This patented technology enables the simulation of wood grain, and even marble or granite finish through the use of decorative powder coating.

The wood grain finish is so realistic that it's almost undistinguishable from real wood, even from a close visual inspection. The system of coating permeates the entire thickness of the coat and as a result, the coating cannot be removed by normal rubbing, chipping, or scratching.

The Coating Process

After pre-treatment the prepared parts are powder coated with a specially formulated polyurethane powder. This powder provides protection against wear, abrasion, impact and corrosion and acts as the relief base color for the finalized metal decoration.

The component is then wrapped with a sheet of non-porous film with the selected decoration pattern printed on it using special high temperature inks.

This printed film transfer is vacuum-sealed to the surface for a complete thermo print and then transferred into a customized oven. The oven transforms the ink into different forms within the paint layer before it becomes solid. Finally, the film is removed, and a vivid timber look on aluminum remains.

Wood grain coating can create beautiful wood-looking products of any sort. There are over 300 combinations of designs currently in use. Wood grains can be made with different colors, designs, etc.

Our powder coatings are certified for indoor and outdoor applications and are backed by a comprehensive warranty. These coatings rise to the highest conceivable standard of performance excellence and design innovation.

Added Benefits

- Resistance to salt-acid room, accelerated aging
- Boiling water, lime and condensed water resistant
- Anti-Graffiti, Anti-Slip, Anti-Microbial, Anti-Scratch
- Super durable (UV resistant)
- TGIC free (non-toxic)

Hardware

Provided Hardware is Marine grade 316 Stainless steel.

Anti Seize Screw Holes

Tapped holes are infused with a special anti seize compound designed to prevent seizure of threaded connections, due to electrolysis from heat, corrosive atmospheres and moisture.

Crystal Clear Low Iron Glass Lens

Provided with tempered, impact resistant crystal clear low iron glass ensuring no green glass tinge.

Optics & LED

Precise optic design provides exceptional light control and precise distribution of light.
LED CRI > 80

Lumen - Maintenance Life

L80 /B10 at 50,000 hours (This means that at least 90% of the LED still achieve 80% of their original flux)

Rounded and discrete bollard family. Sleek shallow cylindrical heads for single or double-sided exceptional optical performance and minimal footprint.

A cylindrical shape bollard that complement Jet family designed with downlight distribution with optimal visual comfort through the great glare control fulfilling dark sky criteria. Optional symmetrical and asymmetrical light distributions.

Ideally suited to illuminate walkways, as well as providing decorative light accents in parks and public spaces using high efficiency LEDs The luminaire rated as CLASS I with integral driver. Color temperature 2700K, 3000K, 3500K and 4000K, LED CRI >80.

Die-cast aluminum housing with high corrosion resistance. Extruded aluminum column. Stainless steel fasteners in grade 316. Durable silicone rubber gasket and clear toughened glass. Housing is treated with a chemical chromated protection before powder coating, ensuring high corrosion resistance.

To meet International Dark Sky criteria, 3000k or warmer LEDs must be selected.



Ligman's micro Variable Optical System provides the ability to interchange, mix & rotate optics to provide specific light distributions for optimized spacing and uniformity.

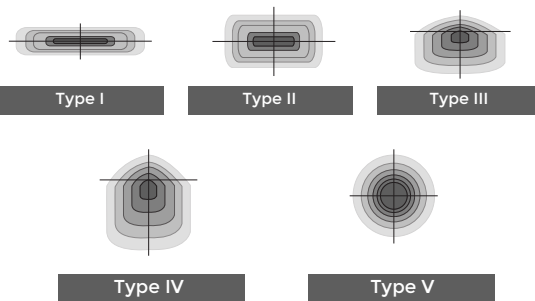

The variable optic system allows for the designer to create hybrid distributions for precise lighting requirements.

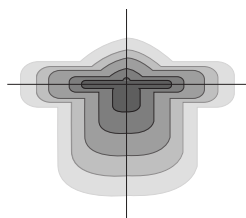

HYBRID
TYPE I & TYPE IV

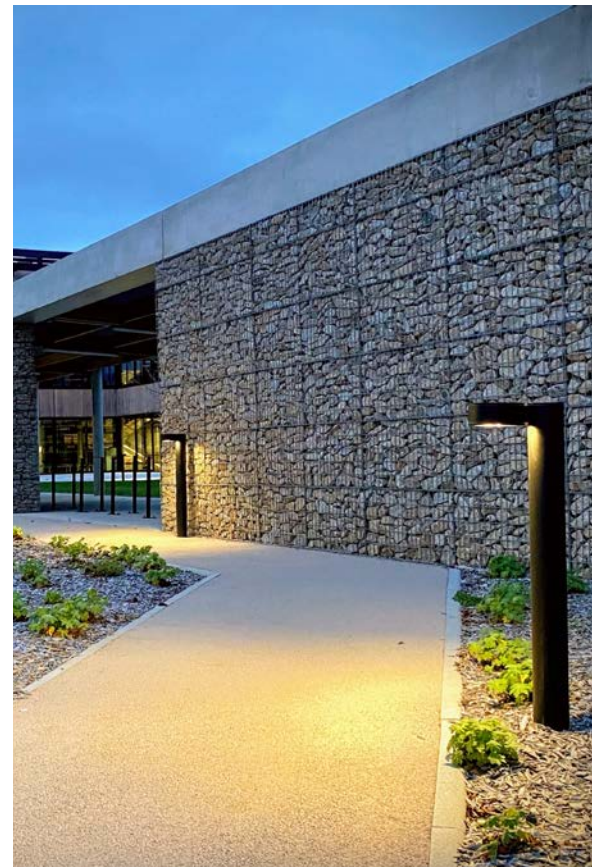





UJE-10572

Jet 57 Cylindrical Single Head Bollard

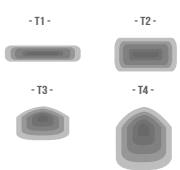

PROJECT	<input type="text"/>	DATE	<input type="text"/>
QUANTITY	<input type="text"/>	TYPE	<input type="text"/>
NOTE	<input type="text"/>		

ORDERING EXAMPLE || UJE - 10572 - 18w - T2 - W30 - 02 - 120/277v - Options

UJE-10572	<input type="text"/>	<input type="text"/>	<input type="text"/>	<input type="text"/>	<input type="text"/>
LAMP	BEAM	LED COLOR	FINISH COLOR	VOLTAGE	
18w LED 2135 Lumens	T1 - Type I Distribution T2 - Type II Distribution T3 - Type III Distribution T4 - Type IV Distribution 	W27 - 2700K  W30 - 3000K  W35 - 3500K W40 - 4000K	01 - BLACK RAL 9011 02 - DARK GREY RAL 7043 03 - WHITE RAL 9003 04 - METALLIC SILVER RAL 9006 05 - MATTE SILVER RAL 9006 06 - LIGMAN BRONZE 07 - CUSTOM RAL 	120/277v Other - Specify	

<input type="text"/>	<input type="text"/>	<input type="text"/>
----------------------	----------------------	----------------------

ADDITIONAL OPTIONS

- NAT - Natatorium Rated
- DIM - 0-10v Dimming
- HGT - Custom Bollard Height
- AMB - Turtle Friendly Amber LED

INSPIRED BY NATURE FINISHES

- SW01 - OAK FINISH
- SW02 - WALNUT FINISH
- SW03 - PINE FINISH
- DF - DOUGLAS FIR FINISH
- CW - CHERRY WOOD FINISH
- NW - NATIONAL WALNUT FINISH
- SU01 - CONCRETE FINISH
- SU02 - SOFTSCAPE FINISH
- SU03 - STONE FINISH
- SU04 - CORTEN FINISH

THERE IS AN ADDITIONAL COST FOR THESE FINISHES

CITY OF FLAGSTAFF & TURTLE FRIENDLY COMPLIANT

AMB Spectral Diagram

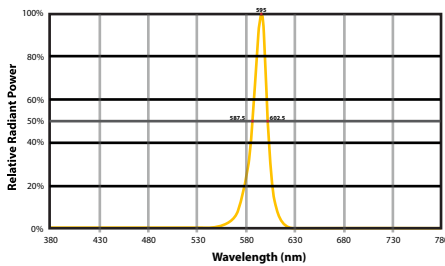

More Custom Finishes Available Upon Request

Consult factory for pricing and lead times



Example: Inspired by Nature Finish



Jet Product Family



Jet 31

• UJE-30351-15w-1618lm [ø4"] - Down



Jet 32

• UJE-30371-15w-1618lm [4"x4"] - Down



Jet 33

• UJE-30391-39w-4094lm [ø6.3"] - Down



Jet 34

• UJE-30411-39w-4094lm [6.3"x6.3"] - Down



Jet 35

• UJE-30341-2x15w-2x1618lm [ø4"] - Up/Down



Jet 36

• UJE-30361-2x15w-2x1618lm [4"x4"] - Up/Down



Jet 37

• UJE-30381-2x39w-2x4094lm [ø6.3"] - Up/Down



Jet 38

• UJE-30401-2x39w-2x4094lm [6.3"x6.3"] - Up/Down



Jet 39

• UJE-80031-14w-1618lm [ø4"]



Jet 40

• UJE-80041-15w-1618lm [4"x4"]



Jet 41

• UJE-80051-39w-4094lm [ø6.3"-11.6"]
• UJE-80052-20w-2284lm [ø6.3"-5.5"]



Jet 42

• UJE-80061-39w-4094lm [6.3"x6.3"-11.6"]
• UJE-80062-20w-2284lm [6.3"x6.3"-5.5"]



Jet 43

• UJE-95081-14w-1618lm [ø4"]



Jet 44

• UJE-95091-14w-1618lm [4"x4"]



Jet 45

• UJE-95111-39w-4094lm [ø6.3"]



Jet 46

• UJE-95121-39w-4094lm [6.3"x6.3"]



Jet 47

• UJE-10555-15w-1618lm



Jet 48

• UJE-10565-2x15w-2x1618lm

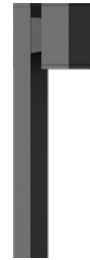

Jet 49

• UJE-20001-35w-4094lm

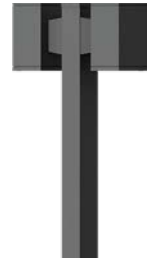

Jet 50

• UJE-20002-2x35w-2x4094lm



Jet 51

• UJE-10581-2x10w-2x1132lm
• UJE-10582-2x18w-2x2135lm
• UJE-10583-2x15w-2x1191lm



Jet 52

• UJE-30413-33w RGBW-1429lm [6.3"x6.3"] - Down



Jet 53

• UJE-30383-2x33w RGBW-2x1429lm [ø6.3"] - Up/Down



Jet 54

• UJE-30403-2x33w RGBW-2x1429lm [6.3"x6.3"] - Up/Down



Jet 57

• UJE-10571-10w-1132lm
• UJE-10572-18w-2135lm
• UJE-10573-15w-1191lm



Jet 58

• UJE-10581-2x10w-2x1132lm
• UJE-10582-2x18w-2x2135lm
• UJE-10583-2x15w-2x1191lm