

UMC-20011

Macaron 2 Post Top



81w LED
7263 Lumens

60w LED
5380 Lumens

50w LED
4483 Lumens

30w LED
2690 Lumens

IP66
Suitable for wet locations

IK08
Impact Resistant [Vandal Resistant]

EPA - 1.00

Weight - 23.1 lbs

POLE NOT INCLUDED



Construction

Aluminum

Less than 0.1% copper content - Marine Grade 6060 extruded & LM6 Aluminum High Pressure die casting provides excellent mechanical strength, clean detailed product lines and excellent heat dissipation.

Pre paint

8 step degrease and phosphate process that includes deoxidizing and etching as well as a zinc and nickel phosphate process before product painting.

Memory Retentive -Silicon Gasket

Provided with special injection molded "fit for purpose" long life high temperature memory retentive silicon gaskets. Maintains the gaskets exact profile and seal over years of use and compression.

Thermal management

LM6 Aluminum is used for its excellent mechanical strength and thermal dissipation properties in low and high ambient temperatures. The superior thermal heat sink design by Ligman used in conjunction with the driver, controls thermals below critical temperature range to ensure maximum luminous flux output, as well as providing long LED service life and ensuring less than 10% lumen depreciation at 50,000 hours.

Surge Suppression

Standard 10kv surge suppressor provided with all fixtures.

BUG Rating

B1 - U0 - G1

Finishing

All Ligman products go through an extensive finishing process that includes fettling to improve paint adherence.

Paint

UV Stabilized 4.9Mil thick powder coat paint and baked at 200 Deg C. This process ensures that Ligman products can withstand harsh environments. Rated for use in natoriums.

Hardware

Provided Hardware is Marine grade 316 Stainless steel.

Anti Seize Screw Holes

Tapped holes are infused with a special anti seize compound designed to prevent seizure of threaded connections, due to electrolysis from heat, corrosive atmospheres and moisture.

Crystal Clear Low Iron Glass Lens

Provided with tempered, impact resistant crystal clear low iron glass ensuring no green glass tinge.

Optics & LED

Precise optic design provides exceptional light control and precise distribution of light. LED CRI > 80

Lumen - Maintenance Life

L80 /B10 at 50,000 hours (This means that at least 90% of the LED still achieve 80% of their original flux)

Modern, contemporary post top Beautiful modern urban post top in either single or V-arm configuration, offering powerful street lighting and asymmetric beam performance choices.

A modern style die-cast aluminum post top decorative lantern with excellent downward light distribution that complies with dark sky requirements. Outstanding visual appeal and precision optical system gives very low glare rating, whilst reducing light pollution. This luminaire is available in two configurations, namely a single or v-arm option to suit aesthetic design requirements.

Color temperature 2700K, 3000K, 3500K and 4000K, LED CRI >80 and life time 50,000 Hours. Stainless steel screws. Durable silicone rubber gasket and clear tempered glass. Powder paint with high corrosion resistance with chemical chromatised protection. Integral control gear.

Customer specific wattages can be provided, please contact the factory for more information.

Available with a selection of dimmable integral electronic drivers, as well as a provision to install wireless lighting controls to integrate with building management systems. (WATT-ADJ) This luminaire is provided with a programmable driver so that specific wattage requirements can be achieved. These settings are done at the factory during assembly.

To meet International Dark Sky criteria, 3000k or warmer LEDs must be selected.

Additional Options (Consult Factory For Pricing)



A90991
Zhaga Book 18



A90891
NEMA 7



RGBW
RGBW Macaron

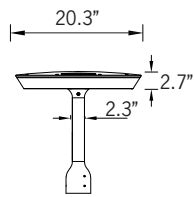

Fixture Detail

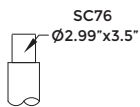

Tenon Detail

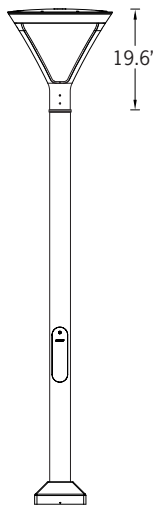

Ligman's micro Variable Optical System provides the ability to interchange, mix & rotate optics to provide specific light distributions for optimized spacing and uniformity.

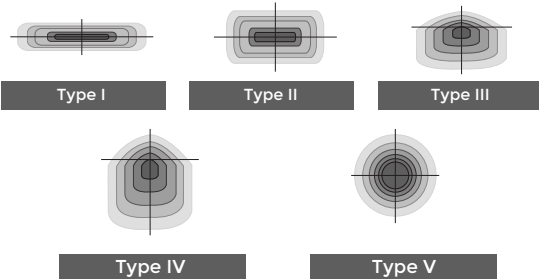

The variable optic system allows for the designer to create hybrid distributions for precise lighting requirements.

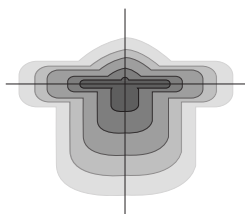

HYBRID
TYPE I & TYPE IV



LIGHCONNECT
IoT Ready Macaron

This luminaire is available with NEMA 7 or Zhaga Book 18 sockets for connection to intelligent lighting control systems.

SPLIT BEAM OPTIONS

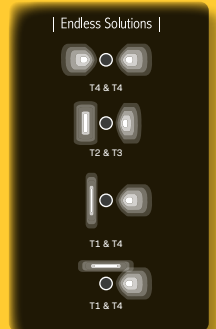

UMC-20011

Macaron 2 Post Top



PROJECT		DATE	
----------------	--	-------------	--

QUANTITY		TYPE		NOTE	
-----------------	--	-------------	--	-------------	--

ORDERING EXAMPLE || UMC - 20011 - 81w - T2 - W30 - 02 - 120/277v - Options

UMC-20011					
LAMP	BEAM	LED COLOR	FINISH COLOR	VOLTAGE	
81w LED 7263 Lumens 60w LED 5380 Lumens 50w LED 4483 Lumens 30w LED 2690 Lumens	T1 - Type I Distribution T2 - Type II Distribution T3 - Type III Distribution T4 - Type IV Distribution T5 - Type V Distribution ME - Type ME Distribution FOR SPLIT BEAM, SPECIFY BELOW	W27 - 2700K W30 - 3000K W35 - 3500K W40 - 4000K	01 - BLACK RAL 9011 02 - DARK GREY RAL 7043 03 - WHITE RAL 9003 04 - METALLIC SILVER RAL 9006 05 - MATTE SILVER RAL 9006 06 - LIGMAN BRONZE 07 - CUSTOM RAL	 120/277v Other - Specify	

SPLIT BEAM LEFT

SPLIT BEAM RIGHT

- | | |
|---|---|
| <ul style="list-style-type: none"> T1 - Type I Distribution T2 - Type II Distribution T3 - Type III Distribution T4 - Type IV Distribution T5 - Type V Distribution ME - Type ME Distribution | <ul style="list-style-type: none"> T1 - Type I Distribution T2 - Type II Distribution T3 - Type III Distribution T4 - Type IV Distribution T5 - Type V Distribution ME - Type ME Distribution |
|---|---|

--	--	--

ADDITIONAL OPTIONS

- | | |
|--|--|
| <ul style="list-style-type: none"> DIM - 0-10v Dimming NAT - Natatorium Rated A20491 - Root Mount Kit A90891 - NEMA 7 BS - Bird Spikes RGBW - RGBW Macaron | <ul style="list-style-type: none"> OS - FSP Occupancy Sensor [See last page] FSIR - Occupancy Sensor Remote Programmer [See last page] A90991-U - Zhaga Book 18 Mounted On Top of Fixture A90991-D - Zhaga Book 18 Mounted Below Fixture AMB - Turtle Friendly Amber LED IHSS - Internal House Side Shield |
|--|--|

CITY OF FLAGSTAFF & TURTLE FRIENDLY COMPLIANT

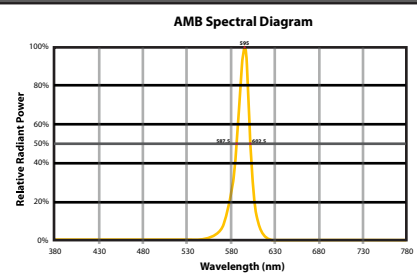

Narrow-Spectrum Amber LEDs
 Peak wavelength between 585 & 595 nanometers and a full width of 50% power no greater than 15 nanometers.

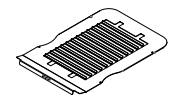
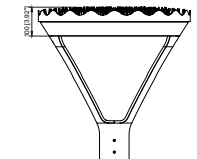
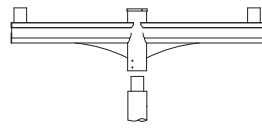
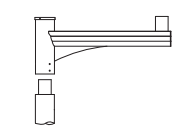
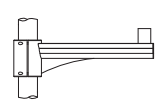

A20176 Aluminum Arm Pole Clamp	A20276 Aluminum Single Arm	A20376 Aluminum Double Arm	BS Bird Spikes	IHSS Internal House Side Shield
--	--------------------------------------	--------------------------------------	--------------------------	---



Macaron Product Family



Macaron 1

- UMC-20001-81w-7263lm
- UMC-20002-104w-14374lm



Macaron 2

- UMC-20011-81w-7263lm
- UMC-20012-104w-14374lm



Macaron 3

- UMC-98001-104w-14374lm



Macaron 4

- UMC-10001-22w-2854lm [23.6°]
- UMC-10002-31w-3904lm [23.6°]
- UMC-10003-46w-5021lm [23.6°]



Macaron 5

- UMC-10011-22w-2854lm [39.3°]
- UMC-10012-31w-3904lm [39.3°]
- UMC-10013-46w-5021lm [39.3°]



Macaron 8

- UMC-20041-22w-2854lm

HIGH/LOW/OFF PIR OUTDOOR PHOTO/MOTION SENSOR IP66 - **legrand**® Integrated photocell

Ligman provides integrated photocell control using the wattstopper legrand FSP-211B. These units are installed inside the fixture housing with only the external lenses being visible



FSP-211B

Dimensions of Lens Options

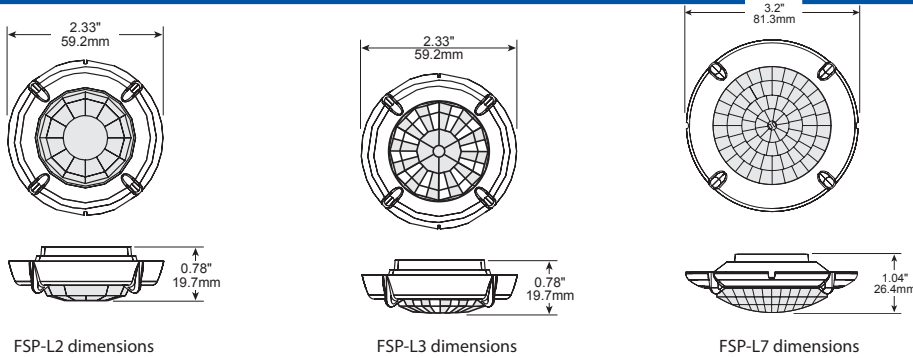

Product Overview

The FSP-221B is a family of passive infrared (PIR) outdoor sensors that raise or lower the electric lighting level to high, low or off based on motion and/or daylight contribution. Typically, once the sensor stops detecting movement and the time delay elapses, lights will first fade to low mode, and eventually switch off. When motion is detected, the sensor ramps the light level to high mode unless the daylight contribution is sufficient.

The integral photocell can also switch the lights on and off for dusk to dawn control, so that lighting remains on overnight even without motion detection.

The sensors control 0-10VDC or nondimming LED drivers or ballasts.

The low voltage FSP-201B may be used with dim-to-off drivers or ballasts.

Initial setup and subsequent sensor adjustments are made using a Wireless Handheld Configuration Tool (FSIR-100). This tool enables adjustment of sensor parameters including high/low mode, sensitivity, time delay, cut off and more.

The FSIR-100 can read current parameter settings, and stores up to six sensor parameter profiles to speed commissioning of multiple sensors.

Models

- FSP-211B, 120-277 VAC
- FSP-221B, 100-347 VAC

Specifications and Features

- Three interchangeable lenses for mounting between 8' and 40'
- Remote setup and adjustment with handheld wireless configuration tool
- Adjustable high and low modes (high: 0 to 10V, low: off, 0 to 9.8V)
- Adjustable time delay (30 seconds, 1 to 30 minutes)
- Adjustable cut off delay (none, 1 to 59 minutes, 1 to 5 hours)
- Adjustable sensitivity/service mode (low, med, max; on-fix, off-fix)
- Adjustable setpoints: hold off setpoint (none, 1 to 250 fc, auto); photocell on/off setpoint (1 to 250 fc)
- Adjustable ramp and fade times (1 to 60 seconds)
- Operating temperature: -40°F to +167°F (-40°C to +75°C)
- IP66 rated
- Five year warranty

Factory Defaults

High mode:	10V
Low mode:	1V
Time delay:	5 minutes
Cut off:	1 hour
Setpoint:	Disabled
Sensitivity:	Max
Ramp up time:	Disabled
Fade down time:	Disabled
Photocell On/Off:	Disabled

Coverage

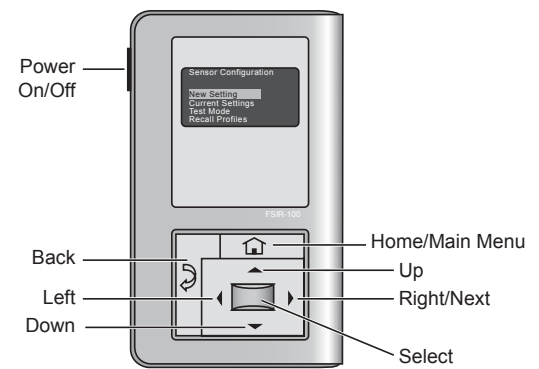
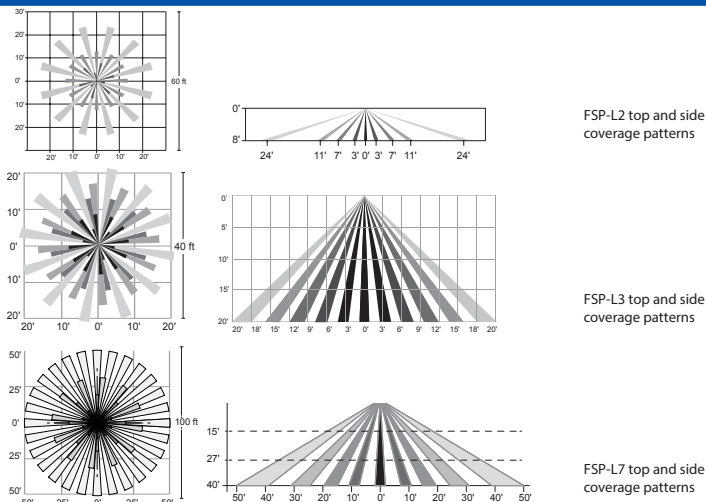

The FSIR-100 is a convenient handheld remote tool for sensor setting. Adjustable settings can be changed as needed for specific applications.

Catalog #	Color	Description
<input type="checkbox"/> FSP-L2	White/Grey/Black/Brown <small>The Trim color option will be selected to closest match fixture color. e.g. (Matte silver fixture - grey trim)</small>	360° lens, maximum coverage 48' diameter from 8' height
<input type="checkbox"/> FSP-L3	White/Grey/Black/Brown <small>The Trim color option will be selected to closest match fixture color. e.g. (Matte silver fixture - grey trim)</small>	360° lens, maximum coverage 40' diameter from 20' height
<input type="checkbox"/> FSP-L7	White/Grey/Black/Brown <small>The Trim color option will be selected to closest match fixture color. e.g. (Matte silver fixture - grey trim)</small>	360° lens, maximum coverage 100' diameter from 40' height
<input type="checkbox"/> FSIR-100	Black	Remote Handheld Configuration Tool