

UDE-20001

Denver 1 Single Head



54w LED
6193 Lumens

IP65
Suitable for wet locations

IK08
Impact Resistant [Vandal Resistant]

Weight 55.1 lbs

EPA - 1.20

POLE NOT INCLUDED



Construction

Aluminum

Less than 0.1% copper content – Marine Grade 6060 extruded & LM6 Aluminum High Pressure die casting provides excellent mechanical strength, clean detailed product lines and excellent heat dissipation.

Pre paint

8 step degrease and phosphate process that includes deoxidizing and etching as well as a zinc and nickel phosphate process before product painting.

Memory Retentive -Silicon Gasket

Provided with special injection molded “fit for purpose” long life high temperature memory retentive silicon gaskets. Maintains the gaskets exact profile and seal over years of use and compression.

Thermal management

LM6 Aluminum is used for its excellent mechanical strength and thermal dissipation properties in low and high ambient temperatures. The superior thermal heat sink design by Ligman used in conjunction with the driver, controls thermals below critical temperature range to ensure maximum luminous flux output, as well as providing long LED service life and ensuring less than 10% lumen depreciation at 50,000 hours.

Surge Suppression

Standard 10kv surge suppressor provided with all fixtures.

BUG Rating

B1 - U0 - G1

Finishing

All Ligman products go through an extensive finishing process that includes fettling to improve paint adherence.

Paint

UV Stabilized 4.9Mil thick powder coat paint and baked at 200 Deg C. This process ensures that Ligman products can withstand harsh environments. Rated for use in natatoriums.

Hardware

Provided Hardware is Marine grade 316 Stainless steel.

Anti Seize Screw Holes

Tapped holes are infused with a special anti seize compound designed to prevent seizure of threaded connections, due to electrolysis from heat, corrosive atmospheres and moisture.

Crystal Clear Low Iron Glass Lens

Provided with tempered, impact resistant crystal clear low iron glass ensuring no green glass tinge.

Optics & LED

Precise optic design provides exceptional light control and precise distribution of light. LED CRI > 80

Lumen - Maintenance Life

L80 /B10 at 50,000 hours (This means that at least 90% of the LED still achieve 80% of their original flux)

Public realm contemporary column family. Exclusive and charismatic column-mounting system offering infinite opportunities and different permutations.

New adjustable architectural linear housings and high performance type II, III, & IV optics give the Denver series greater flexibility for designers to specify single, double, two step, and three step luminaires with 360 degree aiming on a 4.5” round pole. Available in 2700K, 3000K, 3500K and 4000K color temperatures and >80CRI LEDs this Dark Sky rated fixture is perfectly suited for use in pedestrian, streetscapes, plazas and area/parking lots.

The fixture is manufactured with a low copper content corrosion resistant die-cast aluminum construction for durable performance. Non aging silicone gaskets, IK rated clear tempered glass lens and standard 10kv surge protection add peace of mind to this product. The luminaire is treated with a chemical nickel and zinc phosphate protection before powder coating (4.7 mil thickness), ensuring high corrosion resistance. Integral control gear and 316 stainless hardware.

(WATT-ADJ) This luminaire is provided with a programmable driver so that specific wattage requirements can be achieved. These settings are done at the factory during assembly. (See options on page 2).

To meet International Dark Sky criteria, 3000k or warmer LEDs must be selected and luminaire fix mounted (+/- 15° allowable to permit leveling).

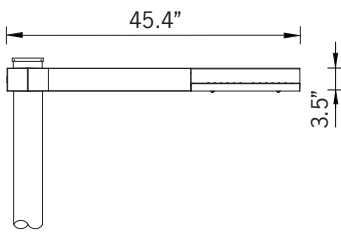

Additional Options (Consult Factory For Pricing)

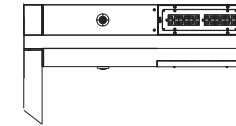

OS
Occupancy Sensor



Ligman's micro Variable Optical System provides the ability to interchange, mix & rotate optics to provide specific light distributions for optimized spacing and uniformity.

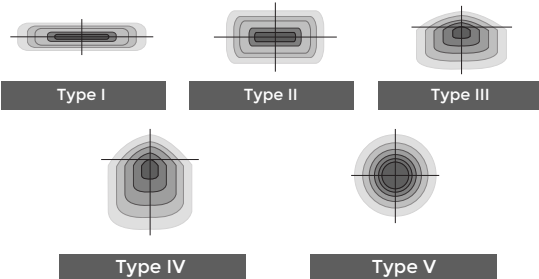

The variable optic system allows for the designer to create hybrid distributions for precise lighting requirements.

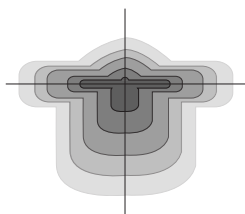

HYBRID
TYPE I & TYPE IV



UDE-20001

Denver 1 Single Head



PROJECT		DATE	
----------------	--	-------------	--

QUANTITY		TYPE		NOTE	
-----------------	--	-------------	--	-------------	--

ORDERING EXAMPLE || UDE - 20001 - 54w - T2 - W30 - 02 - 120/277v - Options

UDE-20001					
LAMP	BEAM	LED COLOR	FINISH COLOR	VOLTAGE	
54w LED 6193 Lumens	T1 - Type I Distribution T2 - Type II Distribution T3 - Type III Distribution T4 - Type IV Distribution	W27 - 2700K W30 - 3000K W35 - 3500K W40 - 4000K	01 - BLACK RAL 9011 02 - DARK GREY RAL 7043 03 - WHITE RAL 9003 04 - METALLIC SILVER RAL 9006 05 - MATTE SILVER RAL 9006 06 - LIGMAN BRONZE 07 - CUSTOM RAL	120/277v Other - Specify	

--	--	--	--

ADDITIONAL OPTIONS

- | | |
|---|--|
| <ul style="list-style-type: none"> DIM - 0-10v Dimming NAT - Natatorium Rated A20491 - Root Mount Kit F - Frosted Lens GFCI - GFCI Box | <ul style="list-style-type: none"> WLC - Wireless Lighting Controls HSS - House Side Shield AMB - Turtle Friendly Amber LED OS - FSP Occupancy Sensor [See last page] FSIR - Occupancy Sensor Remote Programmer [See last page] |
|---|--|

CITY OF FLAGSTAFF & TURTLE FRIENDLY COMPLIANT

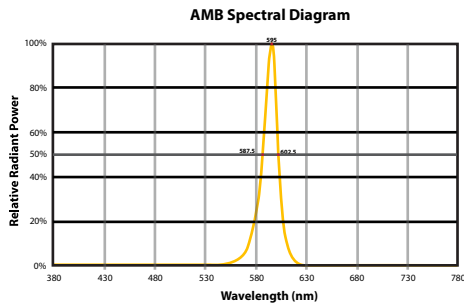

Narrow-Spectrum Amber LEDs

Peak wavelength between 585 & 595 nanometers and a full width of 50% power no greater than 15 nanometers.



Denver Product Family



LL Denver 1

- UDE-20001-54w-6193lm
- UDE-20002-82w-5926lm
- UDE-20003-105w-12518lm
- UDE-20004-155w-16891lm



LL Denver 2

- UDE-20011-2x54w-2x6193lm
- UDE-20012-2x82w-2x5926lm
- UDE-20013-2x105w-2x12518lm
- UDE-20014-2x155w-2x16891lm



LL Denver 3

- UDE-20021-2x54w-2x6193lm
- UDE-20022-2x82w-2x5926lm
- UDE-20023-2x105w-2x12518lm
- UDE-20024-2x155w-2x16891lm



LL Denver 4

- UDE-20031-3x54w-3x6193lm
- UDE-20032-3x82w-3x5926lm
- UDE-20033-3x105w-3x12518lm
- UDE-20034-3x155w-3x16891lm

HIGH/LOW/OFF PIR OUTDOOR PHOTO/MOTION SENSOR IP66 - Integrated photocell

Ligman provides integrated photocell control using the wattstopper legrand FSP-211B. These units are installed inside the fixture housing with only the external lenses being visible



FSP-211B

Dimensions of Lens Options

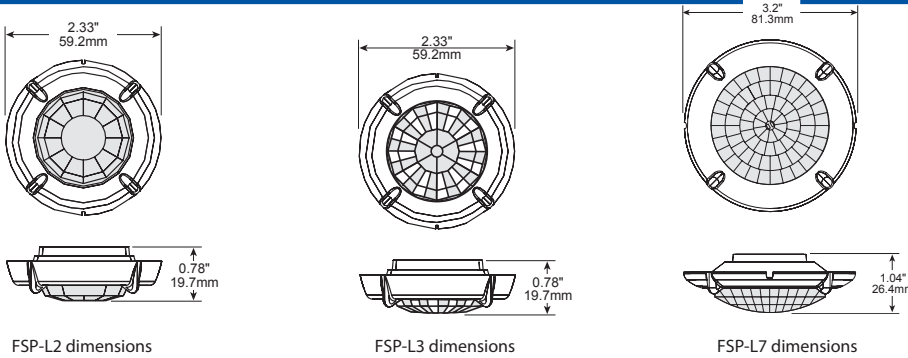

Product Overview

The FSP-221B is a family of passive infrared (PIR) outdoor sensors that raise or lower the electric lighting level to high, low or off based on motion and/or daylight contribution. Typically, once the sensor stops detecting movement and the time delay elapses, lights will first fade to low mode, and eventually switch off. When motion is detected, the sensor ramps the light level to high mode unless the daylight contribution is sufficient.

The integral photocell can also switch the lights on and off for dusk to dawn control, so that lighting remains on overnight even without motion detection.

The sensors control 0-10VDC or nondimming LED drivers or ballasts.

The low voltage FSP-201B may be used with dim-to-off drivers or ballasts.

Initial setup and subsequent sensor adjustments are made using a Wireless Handheld Configuration Tool (FSIR-100). This tool enables adjustment of sensor parameters including high/low mode, sensitivity, time delay, cut off and more.

The FSIR-100 can read current parameter settings, and stores up to six sensor parameter profiles to speed commissioning of multiple sensors.

Coverage

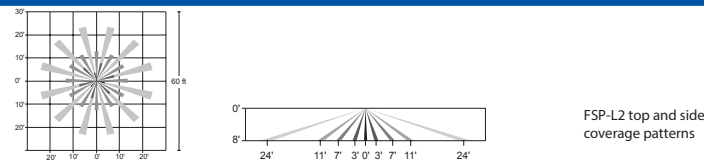

FSP-L2 top and side coverage patterns

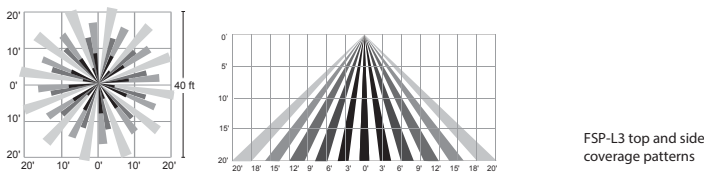

FSP-L3 top and side coverage patterns

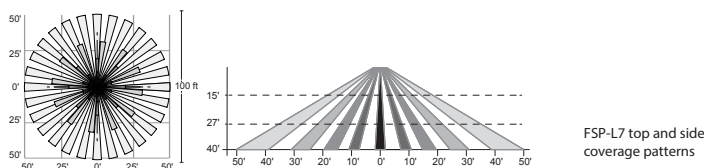



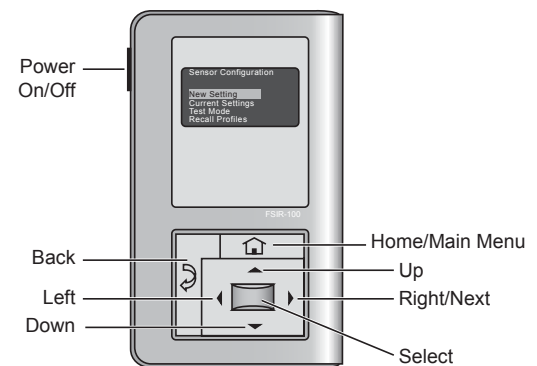

FSP-L7 top and side coverage patterns

Models	
FSP-211B, 120-277 VAC	
FSP-221B, 100-347 VAC	
Specifications and Features	
Three interchangeable lenses for mounting between 8' and 40'	
Remote setup and adjustment with handheld wireless configuration tool	
Adjustable high and low modes (high: 0 to 10V, low: off, 0 to 9.8V)	
Adjustable time delay (30 seconds, 1 to 30 minutes)	
Adjustable cut off delay (none, 1 to 59 minutes, 1 to 5 hours)	
Adjustable sensitivity/service mode (low, med, max; on-fix, off-fix)	
Adjustable setpoints: hold off setpoint (none, 1 to 250 fc, auto); photocell on/off setpoint (1 to 250 fc)	
Adjustable ramp and fade times (1 to 60 seconds)	
Operating temperature: -40°F to +167°F (-40°C to +75°C)	
IP66 rated	
Five year warranty	
Factory Defaults	
High mode:	10V
Low mode:	1V
Time delay:	5 minutes
Cut off:	1 hour
Setpoint:	Disabled
Sensitivity:	Max
Ramp up time:	Disabled
Fade down time:	Disabled
Photocell On/Off:	Disabled



The FSIR-100 is a convenient handheld remote tool for sensor setting. Adjustable settings can be changed as needed for specific applications.

Catalog #	Color	Description
 FSP-L2	White/Grey/Black/Brown <small>The Trim color option will be selected to closest match fixture color. e.g. (Matte silver fixture - grey trim)</small>	360° lens, maximum coverage 48' diameter from 8' height
 FSP-L3	White/Grey/Black/Brown <small>The Trim color option will be selected to closest match fixture color. e.g. (Matte silver fixture - grey trim)</small>	360° lens, maximum coverage 40' diameter from 20' height
 FSP-L7	White/Grey/Black/Brown <small>The Trim color option will be selected to closest match fixture color. e.g. (Matte silver fixture - grey trim)</small>	360° lens, maximum coverage 100' diameter from 40' height
 FSIR-100	Black	Remote Handheld Configuration Tool