

UMA-31621

Mar 9 Surface



Construction

Aluminum

Less than 0.1% copper content – Marine Grade 6060 extruded & LM6 Aluminum High Pressure die casting provides excellent mechanical strength, clean detailed product lines and excellent heat dissipation.

Pre paint

8 step degrease and phosphate process that includes deoxidizing and etching as well as a zinc and nickel phosphate process before product painting.

Memory Retentive -Silicon Gasket

Provided with special injection molded "fit for purpose" long life high temperature memory retentive silicon gaskets. Maintains the gaskets exact profile and seal over years of use and compression.

Thermal management

LM6 Aluminum is used for its excellent mechanical strength and thermal dissipation properties in low and high ambient temperatures. The superior thermal heat sink design by Ligman used in conjunction with the driver, controls thermals below critical temperature range to ensure maximum luminous flux output, as well as providing long LED service life and ensuring less than 10% lumen depreciation at 50,000 hours.

Surge Suppression

Standard 10kv surge suppressor provided with all fixtures.

BUG Rating

B3 - U1 - G0

Finishing

All Ligman products go through an extensive finishing process that includes fettling to improve paint adherence.

Paint

UV Stabilized 4.9Mil thick powder coat paint and baked at 200 Deg C. This process ensures that Ligman products can withstand harsh environments. Rated for use in natatoriums.

Hardware

Provided Hardware is Marine grade 316 Stainless steel.

Anti Seize Screw Holes

Tapped holes are infused with a special anti seize compound designed to prevent seizure of threaded connections, due to electrolysis from heat, corrosive atmospheres and moisture.

Crystal Clear Low Iron Glass Lens

Provided with tempered, impact resistant crystal clear low iron glass ensuring no green tinge.

Optics & LED

Precise optic design provides exceptional light control and precise distribution of light. LED CRI > 80

Lumen - Maintenance Life

L80 /B10 at 50,000 hours (This means that at least 90% of the LED still achieve 80% of their original flux)

Circular surface wall-mounted area downlight. Quintessential wolf in sheep's clothing; street lighting performance hidden inside urban lighting form.

This cylindrical shaped wall mounted luminaire designed to complement the Mar streetlight. This fixture is available in 40w and 58w versions with Type II, III & IV distributions, as well as Type V distribution in a medium, wide, very wide and extra wide beam spreads.

The high ingress protection allows these luminaires to be wall mounted for upward or downward lighting. The Mar can be aimed to suit specific light patterns with the adjustable arm. These fixtures can be provided with internal optic variations for precise light distribution requirements. An example of this is using a combination of using Type II and Type IV distribution optics inside the same fixture.

This fixture can be aimed by tilting the housing using one of the two specifiable options of wall mount brackets, namely the stirrup bracket or small adjustable arm. Other options include; frosted lens, integral photo cell and occupancy sensor.

All Ligman fixtures can be manufactured using a special pre-treatment and coating process that ensures the fixture can be installed in natatoriums as well as environments with high concentrations of chlorine or salt and still maintain the 5 year warranty. For this natatorium rated process please specify NAT in options.

To meet International Dark Sky criteria, 3000k or warmer LEDs must be selected and luminaire fix mounted (+/- 15° allowable to permit leveling).

38w LED 4917 Lumens
IP55 • Suitable For Wet Locations
IK07 • Impact Resistant (Vandal Resistant)
Weight 34 lbs

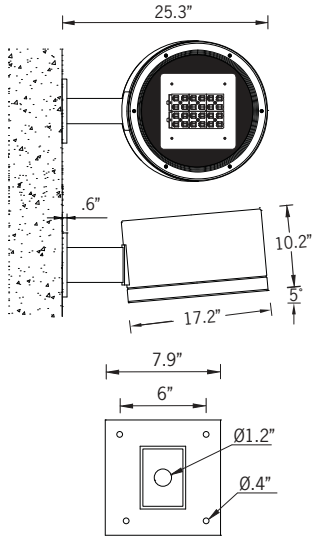

Mounting Detail



Ligman's micro Variable Optical System provides the ability to interchange, mix & rotate optics to provide specific light distributions for optimized spacing and uniformity.

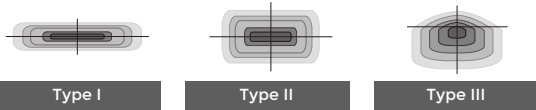

The variable optic system allows for the designer to create hybrid distributions for precise lighting requirements.

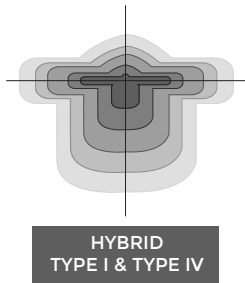

Additional Options (Consult Factory For Pricing)

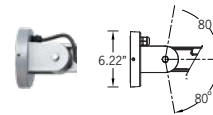

SAM
Small Adjustable Arm

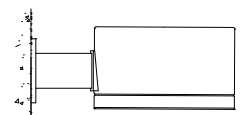

OD
0° Tilt Head

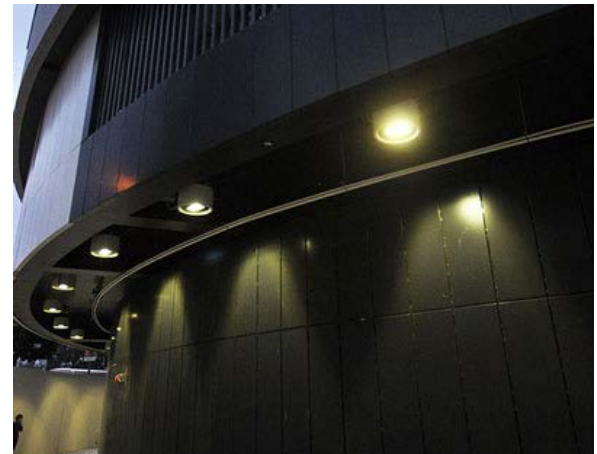

PROJECT		DATE	
----------------	--	-------------	--

QUANTITY		TYPE		NOTE	
-----------------	--	-------------	--	-------------	--

ORDERING EXAMPLE || UMA - 31621 - 38w - M - W30 - 02 - 120/277v - Options

UMA-31621					
LAMP	BEAM	LED COLOR	FINISH COLOR	VOLTAGE	
38w LED 4917 Lumens	M - Medium 30° W - Wide 52° VW - Very Wide 64° EW - Extra Wide 108° T1 - Type I Distribution T2 - Type II Distribution T3 - Type III Distribution T4 - Type IV Distribution	W27 - 2700K W30 - 3000K W35 - 3500K W40 - 4000K	01 - BLACK RAL 9011 02 - DARK GREY RAL 7043 03 - WHITE RAL 9003 04 - METALLIC SILVER RAL 9006 05 - MATTE SILVER RAL 9006 06 - LIGMAN BRONZE 07 - CUSTOM RAL	120/277v Other - Specify	

--	--	--	--

ADDITIONAL OPTIONS

- NAT - Natatorium Rated
- DIM - 0-10v Dimming
- SAM - Small Adjustable Arm
- AMB - Turtle Friendly Amber LED
- OCC - Occupancy Sensor with Integrated Photocell
- OD - 0° Tilt Head
- F - Frosted Lens

CITY OF FLAGSTAFF & TURTLE FRIENDLY COMPLIANT

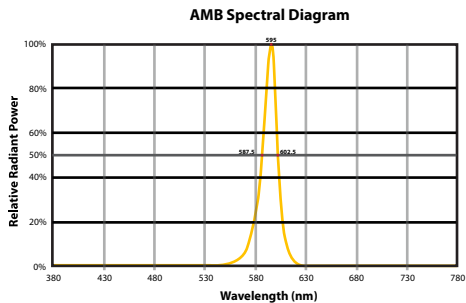

Narrow-Spectrum Amber LEDs

Peak wavelength between 585 & 595 nanometers and a full width of 50% power no greater than 15 nanometers.

Lador Product Family



Mar 9

- UMA-31621-38w-4917lm
- UMA-31622-54w-6666lm



Mar 10

- UMA-97091-38w-4917lm
- UMA-97092-54w-6666lm



Mar 11

- UMA-97101-2x38w-2x4917lm
- UMA-97102-2x54w-2x6666lm