

CATALOG #: _____

Type: _____

PROJECT: _____

FEATURES

- An assortment of finishes are available to complement the architectural elements of any outdoor space
- Designed to accommodate up to two fixtures on a pole top assembly with a maximum 72" O.C. fixture span
- 12' to 30' height options
- Access door provides easy on-site maintenance

SPECIFICATIONS

- SHAFT – 4" O.D. top tapered and stepped round structural pole spun from seamless 6000 series aluminum alloy with decorative cast aluminum components.
- POLE TOP – Plate and tenon provided for top mount luminaire. Removable finial available for poles receiving drilling patterns for side-mount luminaire arm assemblies.
- HANDHOLE – Covered handhole and grounding provision provided.
- COLLAR & BASE COVER – Clamshell design made from high-quality aluminum casting.
- FINISH – Polyester powder coat bonded to pretreated metal, meets AAMA 2604 specifications for outdoor durability.
- ANCHOR BOLTS – Conform to ASTM F1554 Grade 55, galvanized a minimum of 12" on the threaded end.
- MOUNTING – Anchor base (base plate) cast from 356 alloy aluminum. The completed assembly is heat-treated to a T6 temper after the structural welding is completed. A mounting template is provided with each pole and anchor bolt order.

ORDERING EXAMPLE: AV60 - A - 120 - 40 - 156 - T - TM238 - DBR - AB - OPTIONS

ORDERING INFO

SERIES	MATERIAL	HEIGHT	TOP DIAMETER	WALL THICKNESS	SHAFT STYLE
AV60	A Aluminum	120	40 4"	156 0.156" ^[2]	T Tapered Round
		140		188 0.188" ^[3]	
		160		250 0.250" ^[4]	
		180			
		200			
		250			
		300			
		SL___	Special pole length ^[1]		

FIXTURE MOUNTING^[5]

POLE TOP MOUNT

TM238	2-3/8" x 4" Round tenon
TM278	2-7/8" x 4" Round tenon
TM3	3" x 4" Round tenon
TC___	Custom Round Tenon ^[7]

DRILLED SIDE MOUNT^[8]

SM/S	Single 0° ^[9]
SM/D90	Double 90° ^[10]
SM/D180	Double 180° ^[11]
SM/T90	Triple 90° ^[12]
SM/T120	Triple 120° ^[13]
SM/Q90	Quad 90° ^[14]

FINISH^[6]

BLK	Black ^[15]
DBR	Medium bronze
DBZ	Dark bronze
GRAY	Standard gray
GRN	Green ^[16]
SLV	Satin aluminum ^[17]
WHT	White ^[18]
RAL#_____	Specify custom color

ANCHOR BOLTS

AB	Anchor bolts ^[19]
LAB	Less anchor bolts
PAB	Pre-shipped Anchor Bolts ^[20]

OPTIONS

FS	Festoon box only ^[21]
FINIALS ^[22]	
B	Ball
H	South River
M	Metro
N	Pineapple
P	Point
R	Pantheon
S	Spear
V	Burnsville

NOTES

- Please specify, consult factory.
- Up to 200 Height only.
- 180 and 250 Heights only.
- 200, 250, and 300 Heights only.
- Designed for pole top tenon or drilled side mount. See page 2 for MOUNTING DETAILS.
- See page 3 for FINISH OPTIONS.
- Must specify tenon diameter and height, consult factory.
- Removable finial available, see Options.
- Located at 0°.
- Located at 0° and 90°.
- Located at 0° and 180°.
- Located at 0°, 90°, and 180°.
- Located at 0°, 120°, and 240°.
- Located at 0°, 90°, 180°, and 270°.
- RAL #9004.
- RAL #6005.
- RAL #9006.
- RAL #9003.
- Four L-bolts provided with two hex nuts and two flat washers each, shipped with pole.
- Four L-bolts provided with two hex nuts and two flat washers each.
- Casting only. Outlet, cover and hardware by others.
- For poles with side-mount drill only, for additional finial options consult factory. See page 3 for OPTION DETAILS.

AV60 Aluminum Tapered & Stepped Pole & Base

FIXTURE DETAILS

BASE DETAIL

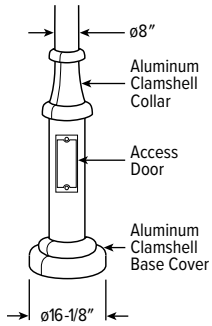

MOUNTING DETAILS

POLE TOP MOUNT TYPICAL TENON

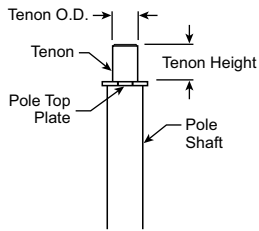

ANCHORAGE DATA

BOLT PROJECTION

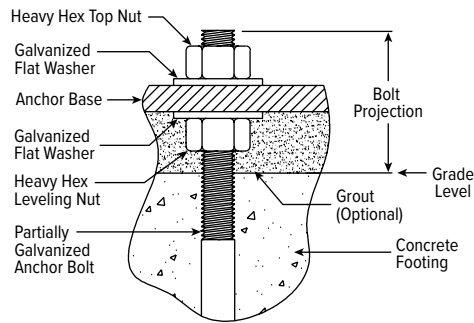

ANCHOR BASE

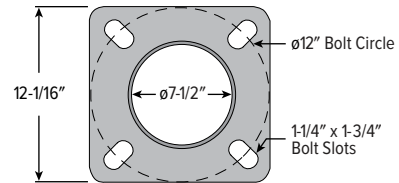

POLE HT.	ANCHOR BOLTS			ANCHOR BASE			
	BOLT SIZE	PROJECTION	±	BOLT CIRCLE		SQ.	THK.
12' - 16'	3/4" x 17" x 3"	3-1/4"	N/A	12"	N/A	12-1/16"	3/4"
18' - 30'	1" x 36" x 4"	3-3/4"	N/A	12"	N/A	12-1/16"	3/4"

DRILLED SIDE MOUNT OPTIONS

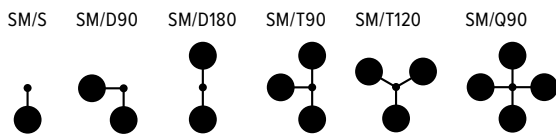

RADIAL INDEX

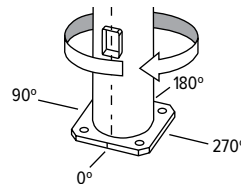
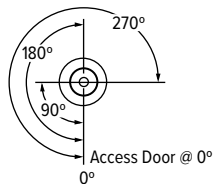

The Radial Index references how parts are oriented around the shaft. A degree measurement is used from a base point. The standard base point of reference is the access door. Degrees are measured in a clockwise motion as viewed from the top of the shaft.

AV60 Aluminum Tapered & Stepped Pole & Base

OPTION DETAILS

ALUMINUM FESTOON BOX

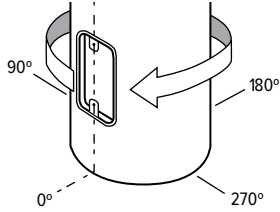

NOTE: The festoon box is located above the access door at 0°.

FINIALS

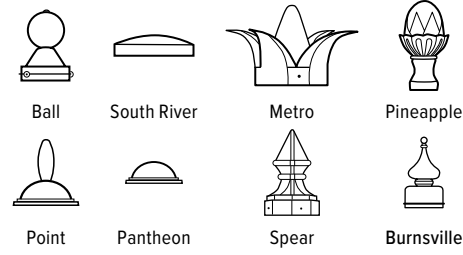

FINISH OPTIONS

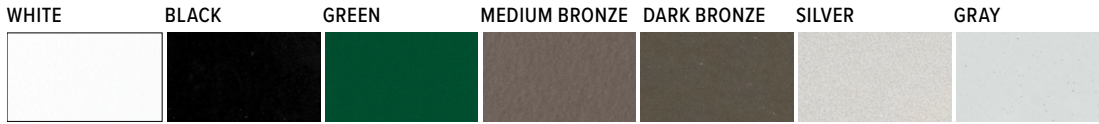

For custom color, please specify RAL code or a manufacturer code with description. All custom colors other than RAL require two sample swatches, minimum 1" square.

AV60 Aluminum Tapered & Stepped Pole & Base

LOAD AND DIMENSIONAL DATA

POLE HT. (FT)	CATALOG NUMBER	POLE DIMENSIONS				80 MPH ^{1,2}		90 MPH ^{1,2}		100 MPH ^{1,2}	
		BASE O.D. (IN)	TOP O.D. (IN)	WALL THK. (IN)	STRUC. WT. ³ (LBS)	MAX LUMINAIRE EPA (SQ FT)	MAX LUMINAIRE WEIGHT (LBS)	MAX LUMINAIRE EPA (SQ FT)	MAX LUMINAIRE WEIGHT (LBS)	MAX LUMINAIRE EPA (SQ FT)	MAX LUMINAIRE WEIGHT (LBS)
12	AV60-A-120-40-156-T	8	4	0.156	49	17.3	65	13.5	65	10.9	65
14	AV60-A-140-40-156-T	8	4	0.156	54	14.5	65	11.2	65	9.0	65
16	AV60-A-160-40-156-T	8	4	0.156	59	12.1	65	9.3	65	7.4	65
	AV60-A-180-40-156-T	8	4	0.156	64	10.2	65	7.7	65	6.1	65
18	AV60-A-180-40-188-T	8	4	0.188	71	12.5	65	9.5	65	7.6	65
	AV60-A-200-40-156-T	8	4	0.156	69	8.5	65	6.3	65	4.9	65
20	AV60-A-200-40-250-T	8	4	0.250	102	14.3	65	10.9	65	8.6	65
	AV60-A-250-40-188-T	8	4	0.188	92	6.7	65	4.7	65	3.6	65
25	AV60-A-250-40-250-T	8	4	0.250	121	9.5	65	7.0	65	5.4	65
	AV60-A-300-40-250-T	8	4	0.250	141	6.0	65	4.0	65	2.9	65

- ¹ Effective Projected Area (EPA) calculations allow for a 1.3 Wind Gust Factor. Maximum EPA and weight values are based on top mounted luminaires or arm assembly having a centroid 3'-0" above and 6'-0" eccentric to the pole top at Nominal Mounting Height. Variations from sizes above are available upon inquiry. Satisfactory performance of poles is dependent upon the pole being properly attached to a supporting foundation of adequate design.
 - ² See WIND MAP below.
 - ³ Structure Weight is a nominal value which includes the pole shaft and structural base.
- Pole installations in various parts of the country perform satisfactorily; however, in select locations destructive vibration can occur. H.E. Williams, Inc. is not responsible for vibration induced fatigue damage.
 - H.E. Williams, Inc. warrants this product to be free from defects in materials and workmanship. Any defective part returned within one year from the date of delivery of the goods will be repaired or replaced without charge, F.O.B. factory.
 - This warranty specifically excludes fatigue or similar phenomena resulting from induced vibration, harmonic oscillation or resonance associated with movement of air currents around the product.
 - The above warranties are given in lieu of all other warranties express or implied, including without limitation, the warranty of merchantability and the warranty of suitability for a particular purpose. It is expressly stated that H.E. Williams, Inc. assumes no liability for consequential or liquidated damages arising out of a breach of the sale, including any warranties arising therefrom, and buyer's remedy shall be limited to repair or replacement of defective parts as described above.
 - Any action for the breach under a sale including any warranties arising therefrom must be commenced within one year after the cause of action accrues.

WIND MAP

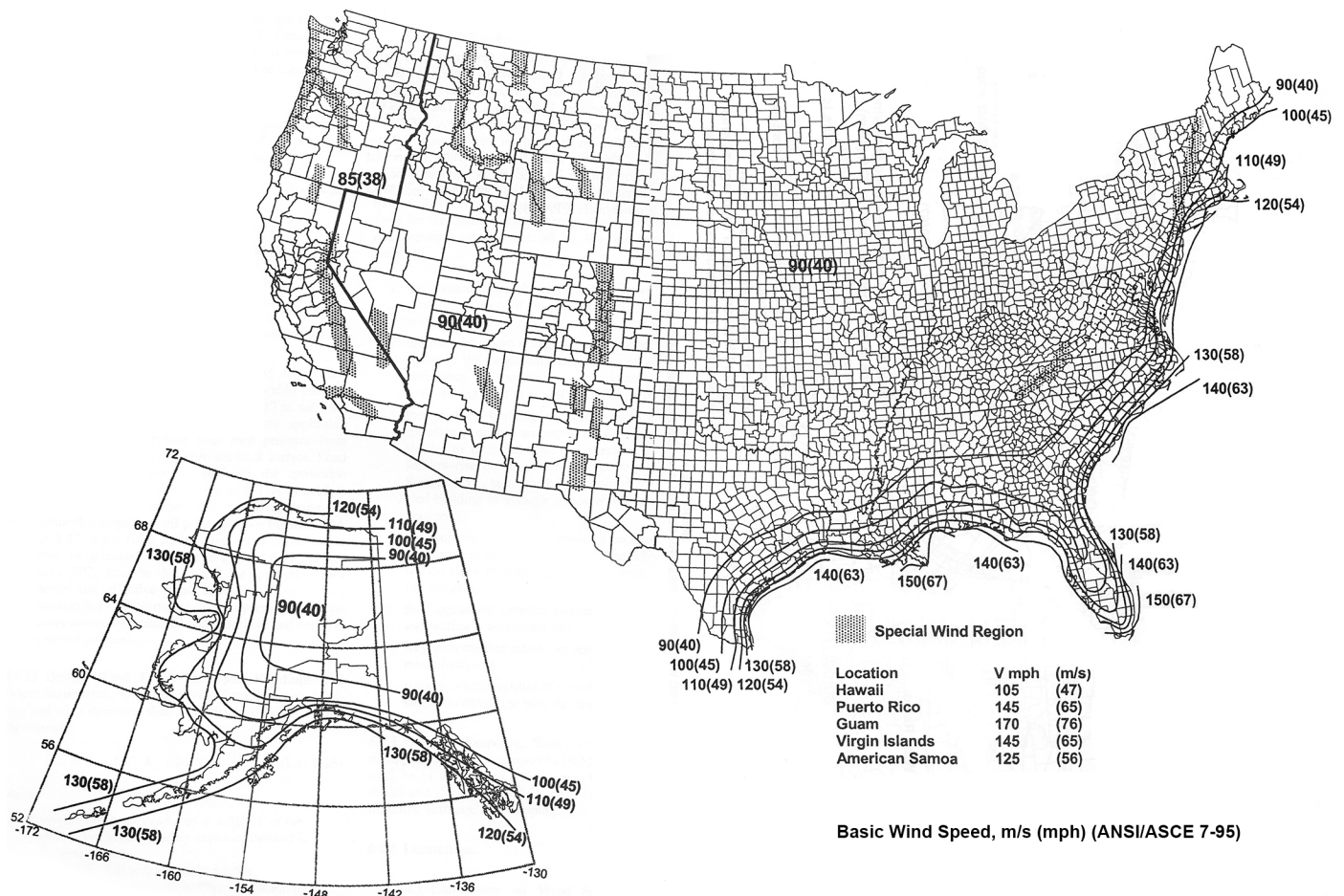

The Effective Projected Area (EPA) standards shown in the Load and Dimensional Data Tables on the specification sheets are designed to withstand dead loads and theoretical dynamic loads developed by variable wind speeds, as charted, with an appropriate wind gust factor under the following conditions:

- Values are nominal design 3-second gust wind speeds in miles per hour (m/s) at 33 ft (10 m) above ground for Exposure C category.

- Linear Interpolation between wind contours is permitted.
- Islands and coastal areas outside the last contour shall use the last wind speed contour of the coastal area.
- Mountainous terrain, gorges, ocean promontories, and special wind regions shall be examined for unusual wind conditions.
- This map is intended as a general guide. Check your local area for unique wind conditions.

From Standard Specifications for Structural Support for Highway Signs, Luminaires, and Traffic Signals, Copyright 2009, by the American Association of State Highway and Transportation Officials, Washington D.C. Used by permission. Documents may be purchased from the AASHTO bookstore at 1-800-231-3475 or online at bookstore.transportation.org