

Microlinea™ Recessed Series 2 - with Flush Lens

(1 7/8" Luminous Aperture)

Catalog Number	Type
Project Name	

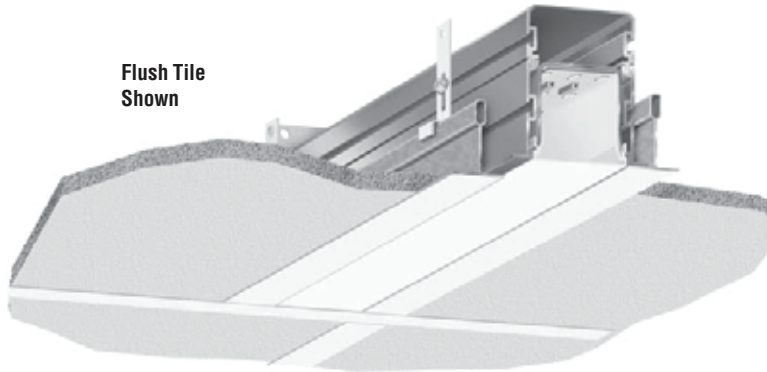

S P E C I F I C A T I O N S

Housing

Three piece extruded aluminum available in single sections up to 8' long. Standard flange finish is satin white.

Optical Controls

- (LOH) LED optimized high transmittance acrylic snap-in lens, formulated for maximum diffusion of the LED light source.
- (BWL) Translucent acrylic snap-in lens with internal prisms providing a batwing-shape light distribution.
- (ASYL) Translucent acrylic snap-in lens providing an asymmetric-shape light distribution.

Reflector/Heat Sink

.040" thick die-formed aluminum finished with a high reflectance white enamel.

Integral Controls

Contact factory for daylight and/or occupancy sensor controls.

Circuitry

All fixtures are factory pre-wired for a single circuit. Provision for multiple switching/circuiting is optional.

Driver (Standard)

Osram-Sylvania "Optotronic" power supply is UL/CUL recognized, 0-10V dimming available, 120-277 universal voltage.

Light Engine (Standard)

LED light source available for 3000K, 3500K, and 4000K CCT, in high and medium light outputs and 80 or 90 CRI. Standard outputs at 80 CRI:

HO-High Output

676 Lms/Ft and 7 Watts/Ft
(Values using 4000K LED modules)

MO-Medium Output

463 Lms/Ft and 4.75 Watts/Ft
(Values using 4000K LED modules)

Driver (Tunable White)

EldoLED power supply is UL recognized, DALI 0-10V, or DMX available, 120-277 universal voltage.

Light Engine (Tunable White)

Tunable White LED light source available for 2700K thru 6500K CCT, and 80 or 90 CRI. Contact factory for available outputs.

Wiring

All fixtures intended for continuous rows are provided with factory installed quick-connect wiring.

Certification

Fixtures are ETL listed for use in 'Dry or Damp Applications.' Conforms to UL Standard #1598 and to CAN/CSA #C22.2No.250.0

Grid Ceilings

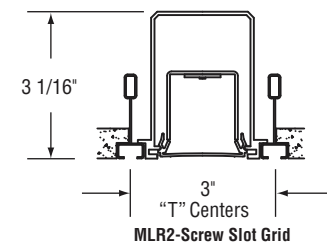
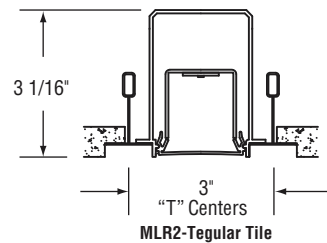
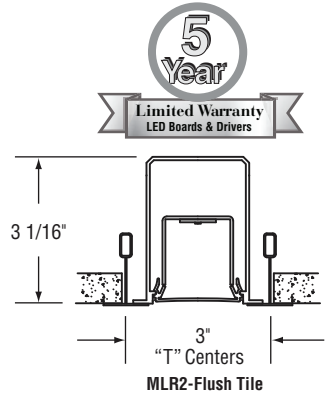

*Due to continued advancement in LED technology, lumen performance is subject to change. Please visit our website for the most up-to-date information.

Sample Catalog Number: **MLR2 - HO - K40 - 80 - 4 - FT - LOH - UNV - DIM1 - OPTIONS**

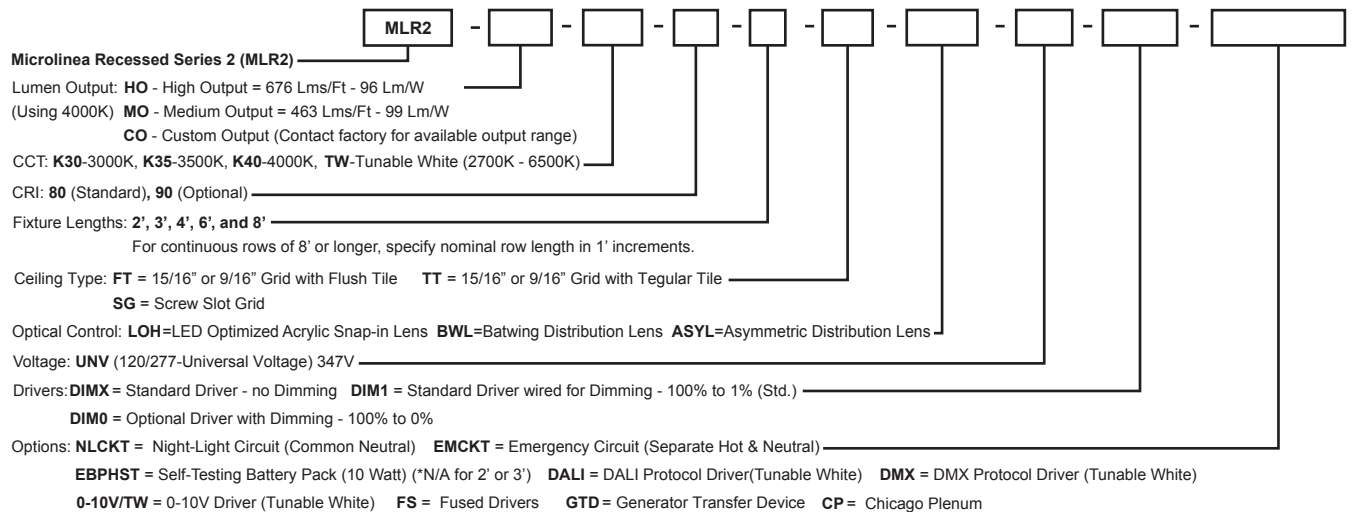

Recessed - Flush Lenses

MLR2-HO-K40-LOH



High Output

LED Optimized High Transmittance Lens

Catalog Number: MLR2-HO-K40-4'-X-LOH-120
 Report Number: #LLIA000530-007.ies
 Luminaire Description: Extruded Aluminum Housing with White Aluminum Reflector and LED Optimized Acrylic Lens
 LED Module: Multiple White Low-Power Light Emitting Diodes (LEDs) in a precise lay-out.

Total Luminaire Efficacy = 96.3 Lm/W
 0% Up 100% Down
 Color Rendering Index (CRI) = 83

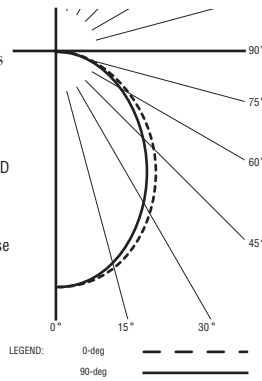

ZONAL LUMEN SUMMARY

Zone	Lumens	% Fixture
0- 30	841	31.1
0- 40	1331	49.2
0- 60	2208	81.6
0- 90	2706	100.0
90- 180	0	0.0
0- 180	2706	100.0

CANDELA DISTRIBUTION

	0.0	22.5	45.0	67.5	90.0
0	1147	1147	1147	1147	1147
5	1140	1133	1141	1140	1134
15	1080	1071	1070	1062	1054
25	969	955	944	926	916
35	820	804	785	761	750
45	651	637	617	591	581
55	479	471	451	427	419
65	315	311	293	277	272
75	164	163	153	144	141
85	45	44	38	33	31
90	0	0	0	0	0

MLR2-MO-K40-LOH



Medium Output

LED Optimized High Transmittance Lens

Catalog Number: MLR2-MO-K40-4'-X-LOH-120
 Report Number: #LLIA000530-05.ies
 Luminaire Description: Extruded Aluminum Housing with White Aluminum Reflector and LED Optimized Acrylic Lens
 LED Module: Multiple White Low-Power Light Emitting Diodes (LEDs) in a precise lay-out.

Total Luminaire Efficacy = 99.5 Lm/W
 0% Up 100% Down
 Color Rendering Index (CRI) = 83

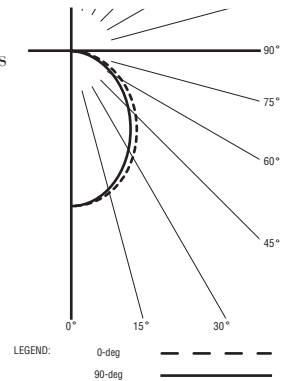

ZONAL LUMEN SUMMARY

Zone	Lumens	% Fixture
0- 30	578	31.2
0- 40	914	49.4
0- 60	1513	81.7
0- 90	1851	100.0
90- 180	0	0.0
0- 180	1851	100.0

CANDELA DISTRIBUTION

	0.0	22.5	45.0	67.5	90.0
0	790	790	790	790	790
5	785	780	786	785	781
15	744	737	736	730	725
25	666	656	648	636	628
35	564	552	538	521	513
45	446	437	422	403	395
55	328	322	307	290	285
65	215	212	200	188	184
75	112	111	104	98	95
85	31	30	26	23	21
90	0	0	0	0	0

MLR2-HO-K40-BWL



High Output

Batwing Distribution Lens

Catalog Number: MLR2-HO-K40-80-4'-X-BWL-UNV
 Report Number: #LLIA001856-001.ies
 Description: Extruded Aluminum Housing with White Aluminum Reflector and Translucent Acrylic (BWL) Lens.
 LED Module: Multiple White Low-Power Light Emitting Diodes (LED) in a precise layout.

Total Luminaire Efficacy = 105.3 Lm/W
 Input Power / 4': 27.09 W
 0% Up 100% Down
 Color Rendering Index (CRI) = 84

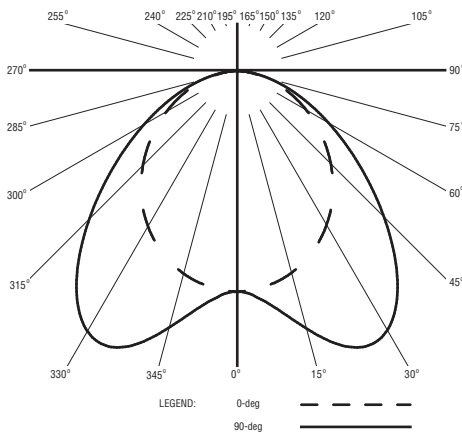

ZONAL LUMEN SUMMARY

Zone	Lumens	% Fixture
0- 30	764	26.7
0- 40	1313	45.9
0- 60	2325	81.3
0- 90	2854	100.0
90- 180	0	0.0
0- 180	2854	100.0

CANDELA DISTRIBUTION

	0.0	22.5	45.0	67.5	90.0
0	823	823	823	823	823
5	816	819	830	842	848
15	781	810	886	962	993
25	712	783	952	1091	1134
35	614	721	940	1036	1040
45	496	615	806	810	778
55	368	470	595	550	512
65	241	308	373	329	304
75	123	154	181	157	146
85	31	37	42	38	36
90	0	0	0	0	0

MLR2-MO-K40-BWL



Medium Output

Batwing Distribution Lens

Catalog Number: MLR2-MO-K40-80-4'-X-BWL-UNV
 Report Number: #LLIA001856-002.ies
 Description: Extruded Aluminum Housing with White Aluminum Reflector and Translucent Acrylic (BWL) Lens.
 LED Module: Multiple White Low-Power Light Emitting Diodes (LED) in a precise layout.

Total Luminaire Efficacy = 107.2 Lm/W
 Input Power / 4': 18.21 W
 0% Up 100% Down
 Color Rendering Index (CRI) = 84

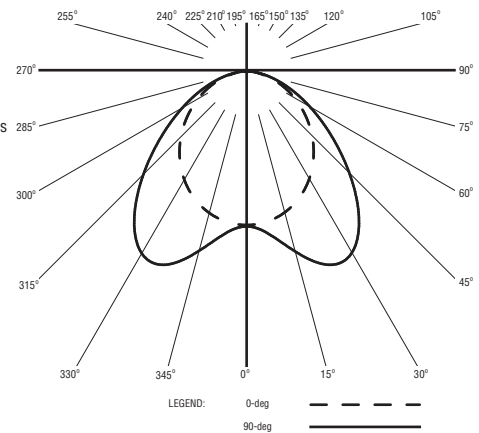

ZONAL LUMEN SUMMARY

Zone	Lumens	% Fixture
0- 30	522	26.7
0- 40	898	45.9
0- 60	1590	81.3
0- 90	1952	100.0
90- 180	0	0.0
0- 180	1952	100.0

CANDELA DISTRIBUTION

	0.0	22.5	45.0	67.5	90.0
0	562	562	562	562	562
5	558	560	567	575	579
15	533	554	606	658	679
25	486	535	651	747	776
35	420	493	643	709	712
45	339	421	552	555	532
55	251	322	408	376	351
65	165	210	256	225	208
75	84	105	124	108	100
85	21	25	29	26	24
90	0	0	0	0	0

For more information, visit our website at www.pal-lighting.com



Precision Architectural Lighting 4830 Timber Creek Drive Houston, Texas 77017
 Tel 713.946.4343 Fax 713.946.4441 www.pal-lighting.com



Made in America