

# CLUSTER

## SURFACE LINEAR

### DESCRIPTION

Cluster is the precise, and scalable family of downlights, wall washers, and adjustables, available in both linear and planar configurations and for recessed, pendant, and surface mounting. Based on a fundamental 1.2" square cell, Cluster delivers lighting that is optically sophisticated and aesthetically refined. Cluster surface linear downlights is available in 1 cell, 3 cell, and 5 cell configurations, all with a choice of precision optics, beam spreads and subtle louver treatments. Surface downlights fit a choice of 3", 8" or 12" deep cuboid enclosures. Nominal light output is 200 lumens per cell. Surface Cluster mount using a choice of direct mount, junction box with canopy, and conduit feed with splice enclosure. Driver is either integral or remote, which is capable of powering multiple luminaires.

# LUMENWERX

PROJECT: \_\_\_\_\_

TYPE: \_\_\_\_\_

NOTES: \_\_\_\_\_

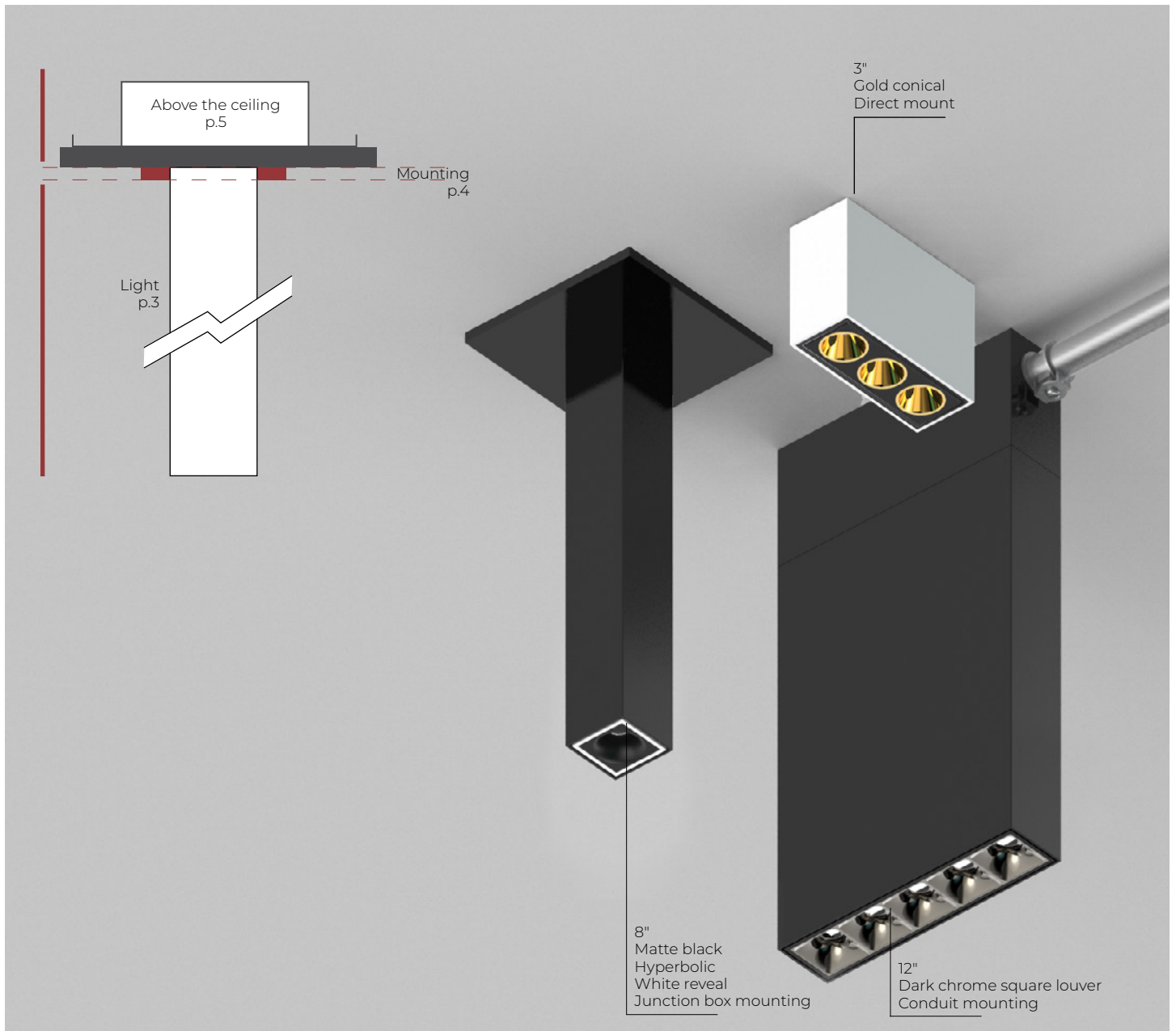

LIGHT

Consult pages 3-4 for details before specifying

LUMINAIRE ID	CUBOID HEIGHT <sup>1</sup>	CUBOID FINISH	LOUVER	LOUVER FINISH	REVEAL FINISH	LIGHT SOURCE	SW	OPTIC
<b>CLUS01</b> - Cluster Surface 1x1 <b>CLUS03</b> - Cluster Surface 3x1 <b>CLUS05</b> - Cluster Surface 5x1	<b>3</b> - 3" <b>8</b> - 8" <b>12</b> - 12"  <sup>1</sup> Conduit mounting option will add 3" to total height.	<b>TMW</b> - Textured matte white <b>TMB</b> - Textured matte black <b>CF#</b> - Custom finish, specify RAL#	<b>CON</b> <sup>2</sup> - Conical <b>HYP</b> - Hyperbolic <b>SQR</b> - Square  <sup>2</sup> Faceplate matches body finish black and white only.	<b>MF01</b> - Matte white <b>MF04</b> - Matte black <b>BL05</b> - Black chrome <b>GL06</b> - Gold <b>CP06</b> - Copper	<b>TMW</b> - Textured matte white <b>TMB</b> - Textured matte black <b>CF#</b> - Custom finish, specify RAL#	<b>SW</b> - Static white		<b>SOF</b> - Soft edge downlight <b>REF</b> - Sharp edge downlight

BEAM	CRI	CLR. TEMP.	DRIVER	VOLTAGE	LUMEN PACKAGE <sup>6</sup>	DIMMING <sup>7</sup>	MOUNTING TYPE	J-BOX PLATE & CONDUIT FINISH
<b>SPT</b> <sup>3</sup> - Spot <b>NFL</b> <sup>4</sup> - Narrow flood <b>FLD</b> - Flood <b>WFL</b> - Wide flood  <sup>3</sup> Available with REF only. <sup>4</sup> Available with SOF only.	<b>90</b> - 90 CRI	<b>27</b> - 2700K <b>30</b> - 3000K <b>35</b> - 3500K <b>40</b> - 4000K	<b>INTEGRAL</b> <sup>5</sup>  <sup>5</sup> Not available with 3" cuboid height.	<b>120</b> - 120V <b>277</b> - 277V	<b>200</b> - 200 lm (CLUS01) <b>578</b> - 578 lm (CLUS03) <b>923</b> - 923 lm (CLUS05)  <sup>6</sup> Lumen packages shown at 3500K, with SOF-NFL 25°. For other, see lumen output multipliers on page 5.	<b>CLUS01</b> <b>ND</b> <sup>8</sup> - No dimming  <b>CLUS03, CLUS05</b> <b>D1</b> - 1% 0-10V <b>ELV</b> <sup>9</sup> - ELV 120V <b>TRI</b> <sup>9</sup> - TRIAC 120V  <sup>7</sup> Integral drivers (in body) not available for 3". <sup>8</sup> Integral driver (in junction box) for CLUS01 available with junction box mounting only. <sup>9</sup> Available with 120V only.	<b>DM</b> <sup>10</sup> - Direct mount <b>JB</b> - Junction box <b>CD</b> <sup>10</sup> - Conduit box  <sup>10</sup> Available with CLUS03 and CLUS05 only.	<b>TMW</b> - Textured matte white <b>TMB</b> - Textured matte black <b>CF#</b> - Custom finish, specify RAL#
			<b>REMOTE</b>	<b>FOR FULL REMOTE DRIVER SPECIFICATION, SEE "REMOTE DRIVER" SECTION BELOW.</b>				

REMOTE DRIVER OPTIONAL

Consult page 5 for details before specifying

Continue here for full remote driver specifications. Remote driver can be ordered separately.

REMOTE DRIVER <sup>11</sup>	LUM. QTY. <sup>12</sup>	LUM. ID	VOLTAGE	LUMEN PACKAGE <sup>13,14</sup>	DIMMING <sup>15</sup>
<b>RDB#</b> - Remote driver  <sup>11</sup> If multiple driver boxes needed, specify a line number for each driver type used. (e.g. <b>RDB1-10X-CLUS01-...-RD1</b> <b>RDB2-8X-CLUS01-...-RD1</b> ...)	<b>#X</b> - Number of luminaires  <sup>12</sup> Specify number of luminaires per remote driver. (e.g. <b>3X</b> )	<b>CLUS01</b> - Cluster Surface 1x1 <b>CLUS03</b> - Cluster Surface 3x1 <b>CLUS05</b> - Cluster Surface 5x1	<b>120</b> - 120V <b>277</b> - 277V <b>UNV</b> - 120V-277V	<b>###</b> - Low <b>50</b> lm - Med <b>125</b> lm - High <b>200</b> lm (CLUS01) <b>###</b> - Low <b>145</b> lm - Med <b>362</b> lm - High <b>578</b> lm (CLUS03) <b>###</b> - Low <b>230</b> lm - Med <b>577</b> lm - High <b>923</b> lm (CLUS05)  <sup>13</sup> Watts and lumen per watts will vary based on the number of lighting units per remote driver as well as on the type of driver selected. <sup>14</sup> Low and medium lumen packages are not available with RELV and RTRI dimming options.	<b>RD1</b> - 1% 0-10V <b>RELV</b> <sup>16</sup> - ELV 120V <b>RTRI</b> <sup>16</sup> - TRIAC 120V <b>RDA</b> <sup>17</sup> - DALI <b>RLTEA2W</b> <sup>16</sup> - Lutron 1% - 2 wire FP 120V <b>RLDEI</b> <sup>17</sup> - Lutron Hi-lume 1% Eco  <sup>15</sup> For configurations involving different clusters sizes on a remote driver, please consult factory. <sup>16</sup> Available with 120V only. <sup>17</sup> On-site commissioning is required.

EXAMPLE ORDER CODES

WHEN SPECIFYING WITH INTEGRAL DRIVER	
<b>LIGHT</b>	CLUS01-3-TMW-CON-MF01-TMW-SW-SOF-NFL-90-35-INTEGRAL-120-200-ND-JB-TMW
<b>REMOTE DRIVER</b>	N/A

WHEN SPECIFYING WITH REMOTE DRIVER <sup>18</sup>	
<b>LIGHT</b>	CLUS01-3-TMW-CON-MF01-TMW-SW-SOF-NFL-90-35-REMOTE-JB-TMW
<b>REMOTE DRIVER</b>	Remote driver 1: RDB1-10X-CLUS01-120-125-RD1 Remote driver 2: RDB2-8X-CLUS01-120-125-RD1

<sup>18</sup> When specifying with multiple remote driver boxes, each driver used needs to be on a separate line and be numbered for the ordering codes.

LIGHT

OPTICS & BEAM ANGLE

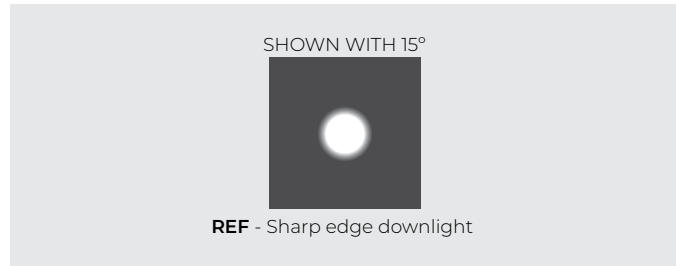
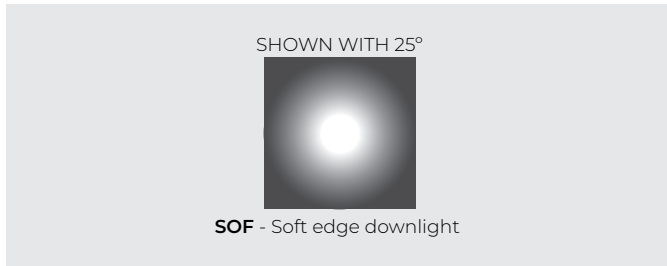

<b>NFL</b> - Narrow flood	<b>FLD</b> - Flood	<b>WFL</b> - Wide flood
Beam angle 25° Field angle 48° Spacing criteria 0.4	Beam angle 35° Field angle 67° Spacing criteria 0.6	Beam angle 55° Field angle 104° Spacing criteria 0.8

<b>SPT</b> - Spot	<b>FLD</b> - Flood	<b>WFL</b> - Wide flood
Beam angle 15° Field angle 39° Spacing criteria 0.2	Beam angle 30° Field angle 49° Spacing criteria 0.5	Beam angle 45° Field angle 62° Spacing criteria 0.8

LOUVER SHAPE

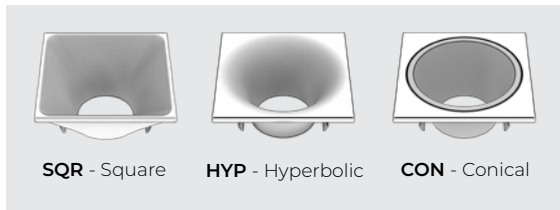

LOUVER FINISH

Louvers are injection molded with integral texture and color

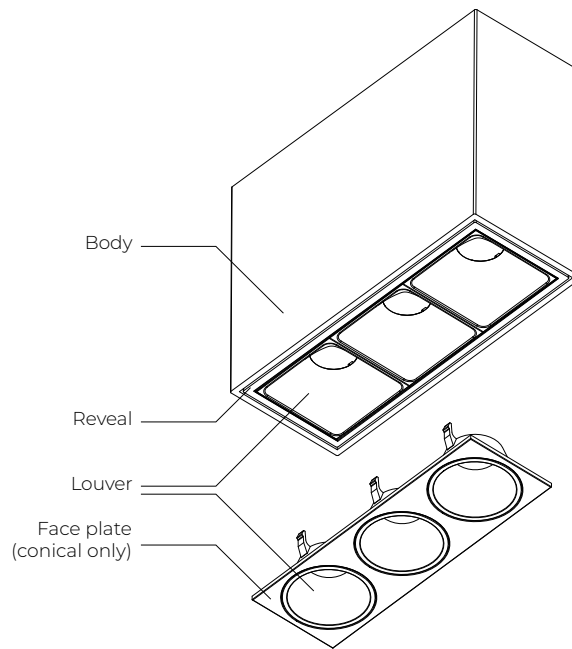

MOUNTING

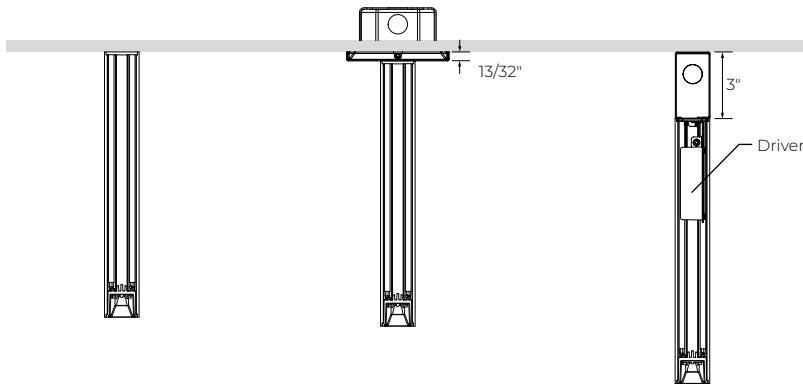

MOUNTING TYPE	
Direct mount	<b>DM</b>
Junction box	<b>JB</b>
Conduit	<b>CD</b>

JUNCTION BOX PLATE & CONDUIT FINISH	
Textured matte white	<b>TMW</b>
Textured matte black	<b>TMB</b>
Custom finish	<b>CF#</b>

**DM - Direct Mount**  
Available with CLUS03 and CLUS05 only

**JB - Junction Box**  
To be attached on a hexagonal junction box

Junction box is covered by the junction box plate

**CD - Conduit**  
For concrete ceiling  
Add 3" to the cuboid length

Available with CLUS03 and CLUS05 only

BOTTOM VIEW

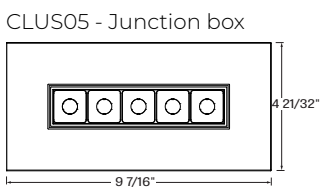
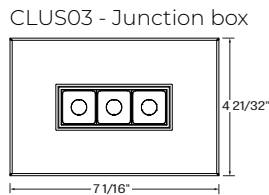
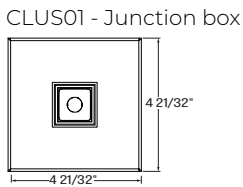
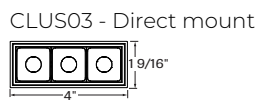
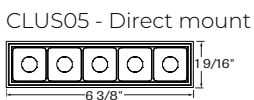

CROSS SECTION

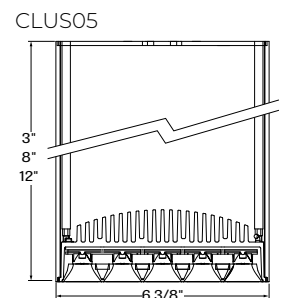
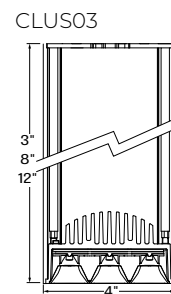
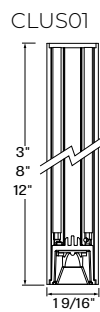

See planar spec sheet for more sizes

See planar spec sheet for more sizes

DRIVER

**INTEGRAL DRIVER** 8" & 12" CUBOID HEIGHT ONLY

The integral driver is sized to the lighting unit and is connected directly with Class 2 wiring and quick-splice connectors. The driver is accessible for service by uninstalling the body and top plate.

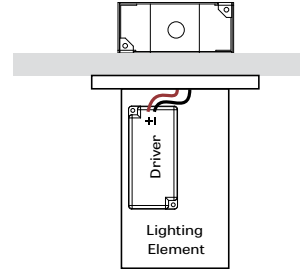

**MULTIPLIER**

GENERAL LUMEN OUTPUT MULTIPLIER AT 90 CRI

OPTICS	2700K						3000K						3500K						4000K					
	SOFT			SHARP			SOFT			SHARP			SOFT			SHARP			SOFT			SHARP		
BEAM ANGLE	25	35	55	15	30	45	25	35	55	15	30	45	25	35	55	15	30	45	25	35	55	15	30	45
LUMEN OUTPUT MULTIPLIER	0.87	0.92	0.82	0.80	0.84	0.86	0.93	0.99	0.87	0.86	0.89	0.92	1	1.06	0.94	0.92	0.96	0.99	1.03	1.09	0.97	0.95	0.99	1.02

LUMEN PACKAGE (AT 3500K, SOFT 25° BEAM) - INTEGRAL DRIVER

LUMINAIRE ID	LUMEN OUTPUT	WATTS	EFFICACY LM/W	LUMEN PACKAGE	VOLTAGE	INTEGRAL DRIVER
CLUS01	200 lm	3.3 W	60 lm/W	Use the multiplier tables to calculate the lumen package	120 - 120V 277 - 277V	<b>CLUS01</b> ND - No dimming
CLUS03	578 lm	7.8 W	74 lm/W			<b>CLUS03, CLUS05</b> D1 - 1% 0-10V ELV <sup>1</sup> - ELV 120V TRI <sup>1</sup> - TRIAC 120V
CLUS05	923 lm	11.8 W	78 lm/W			<sup>1</sup> Available with 120V only.

**REMOTE DRIVER**

The remote driver can power several lighting units, depending on their total power. The minimum and maximum number of lighting units and driver type are shown in the table below and must be observed. The remote driver and lighting units are wired together through connection boxes, which are furnished pre-wired to the driver enclosure. All wiring is Class 2 with quick-splice connectors. The remote driver requires access from above the ceiling (or an access panel).

LUMEN PACKAGE<sup>1</sup> (AT 3500K, SOFT 25° BEAM) - REMOTE DRIVER

LUMINAIRE ID	LUMEN PACKAGE <sup>2</sup>			VOLTAGE	REMOTE DRIVER	NUMBER OF LIGHTING UNITS PER DRIVER
CLUS01 CLUS03 CLUS05	LOW 50 lm 145 lm 230 lm	MEDIUM 125 lm 362 lm 577 lm	HIGH 200 lm 578 lm 923 lm	120 - 120V 277 - 277V UNV - 120V-277V	RD1 - 1% 0-10V RELV <sup>3</sup> - ELV 120V RTRI <sup>3</sup> - TRIAC 120V RDA <sup>4</sup> - DALI RLTEA2W <sup>3</sup> - Lutron 1% - 2 wire FP 120V RLDEI <sup>4</sup> - Lutron Hi-Lume 1% Eco	See table below for maximum and minimum possible number of lighting units per each driver.  For configurations involving different cluster sizes on a remote driver, please consult factory.
<sup>2</sup> Low and medium options are not available with RELV and RTRI.			<sup>3</sup> Available with 120V only. <sup>4</sup> On-site commissioning is required.			

<sup>1</sup>Watts and lumen per watts will vary based on the number of lighting units per remote driver as well as on the type of driver selected.

NUMBER OF LIGHTING UNITS PER DRIVER - MINIMUM AND MAXIMUM

DRIVER TYPE	CLUS01	CLUS03	CLUS05
D1 - 1% 0-10V	8-24	3-8	2-4
ELV - ELV 120V	10-14	3-4	2
TRI - TRIAC 120V	10-14	3-4	2
DA - DALI	8-24	3-8	2-4
LTEA2W - Lutron 1% - 2 wire FP 120V	4-17	2-5	1-3
LDEI - Lutron Hi-Lume 1% Eco	8-16	3-5	2-3

For any quantities of lighting units per driver that fall outside the minimum and maximum listed above, please consult factory.

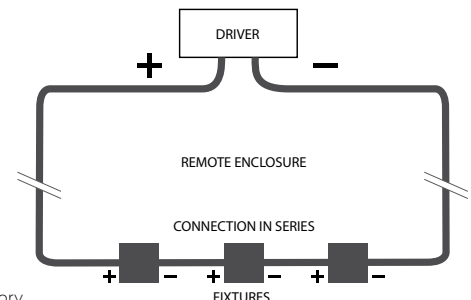

## OPTICS

### SOFT-EDGED FEATHERED BEAM (SOF)

The Soft-Edged Feathered Beam blends the light into darker areas for a gentle brightness transition. Each LED emitter directs light through a single, custom molded circular optic using total internal reflection (TIR) to shape the light. A 0.5" reflective square louver provides a cut off with a UGR of 10. Three different TIR elements create a choice of beam spread: 25° narrow flood (NFL), 35° flood (FLD), or 55° wide flood (WFL).

### SHARP-EDGED CUT-OFF BEAM (REF)

The Sharp-Edged Cut-Off Beam creates dramatic impact, limiting the spread of light outside of the primary beam. A molded conical reflector redirects light from each emitter into the desired beam angle. A 0.5" reflective square louver provides a cut off with a UGR of 10. Three different TIR elements create a choice of beam spread: 15° spot (SPT), 30° flood (FLD), or 45° wide flood (WFL).

## LIGHT SOURCE

Custom array of high-flux LEDs mounted onto aluminum-backed circuitry. Available in 2700K, 3000K, 3500K and 4000K with a minimum 90 CRI with elevated R9 value. Color consistency is maintained to within 3 SDCM. All LEDs have been tested in accordance with IESNA LM-80-08 and the results have shown L80 lumen maintenance greater than 60,000 hours. Absolute product photometry is measured and presented in accordance with IESNA LM-79, unless otherwise indicated.

## WEIGHT

	BODY		CUBOID 3"		CUBOID 8"		CUBOID 12"	
	Lb	Kg	Lb	Kg	Lb	Kg	Lb	Kg
<b>CLUS01</b>	0.50	0.20	0.25	0.11	0.62	0.28	0.92	0.42
<b>CLUS03</b>	0.70	0.30	0.36	0.16	0.87	0.39	1.27	0.58
<b>CLUS05</b>	1.10	0.50	0.85	0.38	2.09	0.95	3.08	1.40

## CONSTRUCTION

**Housing** - Die-cast aluminum (0.95" nominal)

**Optics** - Polycarbonate

**Cuboid** - Aluminum extrusion

**Cover surface** - 16 gauge galvanized steel

**Extension bar** - Galvanized steel

## CERTIFICATIONS

**ETL** - Rated for indoor dry/damp locations.

Conforms to UL 1598 Standard and certified to CAN/CSA Standard C22.2 No. 250.0

## WARRANTY

Lumenwerx provides a five-year limited warranty on electrical and mechanical performance of the luminaires, including the LED boards, drivers, and auxiliary electronics. Lumenwerx will repair or replace defective luminaires or components at our discretion, provided they have been installed and operated in accordance with our specifications. Other limitations apply, please refer to the full warranty on our website.

## SOFT-EDGE DOWNLIGHT

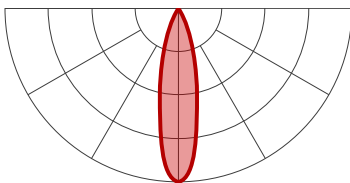

**NFL** - Narrow flood

Beam angle 25°  
Field angle 48°  
Spacing criteria 0.4

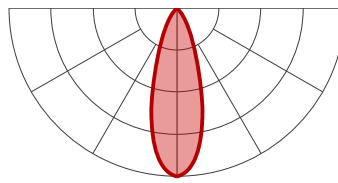

**FLD** - Flood

Beam angle 35°  
Field angle 67°  
Spacing criteria 0.6

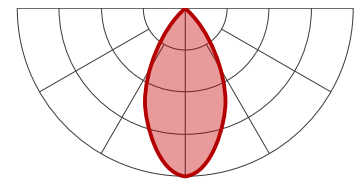

**WFL** - Wide flood

Beam angle 55°  
Field angle 104°  
Spacing criteria 0.8

## SHARP-EDGE DOWNLIGHT

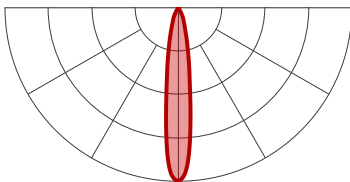

**SPT** - Spot

Beam angle 15°  
Field angle 39°  
Spacing criteria 0.2

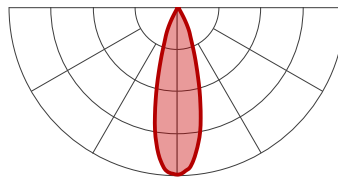

**FLD** - Flood

Beam angle 30°  
Field angle 49°  
Spacing criteria 0.5

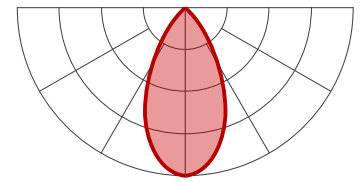

**WFL** - Wide flood

Beam angle 45°  
Field angle 62°  
Spacing criteria 0.8