

NTEK/NHTEK

2-Circuit/2-Neutral 120V and 277V Series Track

Specifications/Features

Track

Ideal for dimming intensive applications.

Independent neutrals guarantee that the two circuits are completely isolated, eliminating cross-circuit interference and enable greater power capacity (2 x 20A) than common neutral track.

Superior dimming capability gives the ability to dim on two independent circuits without harmonics or interference on the neutral conductor.

Oversized conductors for higher operating safety and reduced overload potential.

Secure Bus Bar Insulation secured both conductors and insulation for the life of the product.

Separate mechanical suspension points provide superior weight bearing capacity, ensure electrical contact integrity and reduce the likelihood of arcing.

Polarity ridge takes the guesswork out of connector and track alignment during installation.

Made of architectural grade extruded aluminum. Can be field cut to desired length.

Compatibility



NTEK70

All ConTech track luminaires must have an NTEK adapter installed.

For 120V track, fixture adapter NTEK70 must be ordered separately (NTEK70).

For 277V Track, fixture adapter must be factory installed.

Warranty

Track is covered by ConTech's one (1) year full replacement guarantee after date of purchase.

Listing

cULus listed.

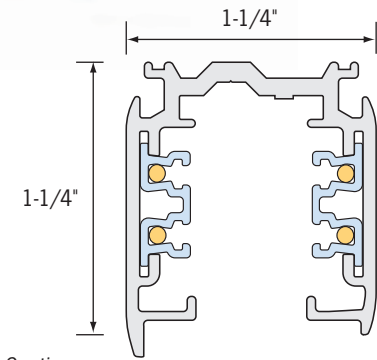
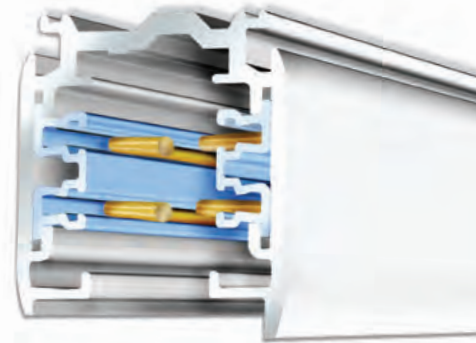

Track Section

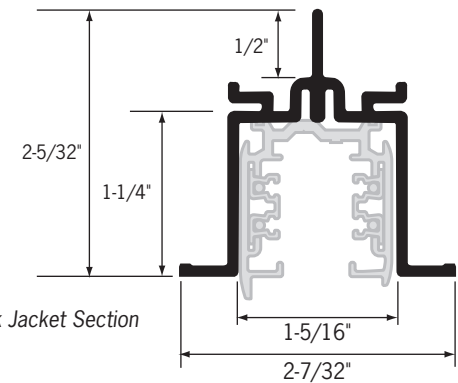

Recessed Track Jacket Section

Ordering Information

Example Order: - -

Track Sections

Track Finish

- NTEK44** - 4' (48") Length 120V Track
- NTEK48** - 8' (96") Length 120V Track
- NTEK412** - 12' (144") Length 120V Track
- NHTEK44** - 4' (48") Length 277V Track
- NHTEK48** - 8' (96") Length 277V Track
- NHTEK412** - 12' (144") Length 277V Track

- B** - Black
- P** - White
- S** - Silver

Recessed Track Jacket Sections

Jacket Finish

- NFTP44** - 4' (48") Length;
51-1/2" Actual Length
- NFTP48** - 8' (96") Length;
99-1/2" Actual Length
- NFTP412** - 12' (144") Length;
147-1/2" Actual Length

- B** - Black
- P** - White

NTEK/NHTEK

2-Circuit/2-Neutral Track Installation Accessories

120V and 277V Series

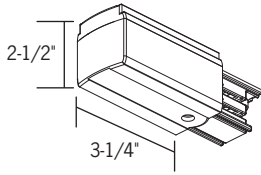

Live End Feeds



NTEK11-(B,P,S) 120V
NHTEK11-(B,P,S) 277V

Live End Feed

NTEK12-(B,P,S) 120V
NHTEK12-(B,P,S) 277V

Live End Feed, Reverse Polarity

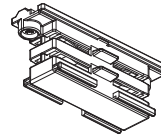
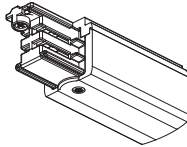

Linear Coupler



NTEK21-(B,P,S) 120V
NHTEK21-(B,P,S) 277V

Does not add length to track run

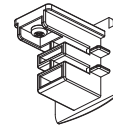

Dead Ends



NTEK41-(B,P,S) 120V
NHTEK41-(B,P,S) 277V

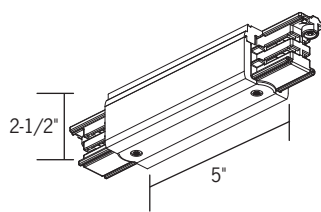

Live Middle Feed



NTEK14-(B,P,S) 120V
NHTEK14-(B,P,S) 277V

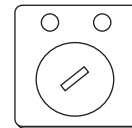

Recessed End Cap



NFTP41-U

For safe, flush mounting applications.
 Natural galvanized steel.

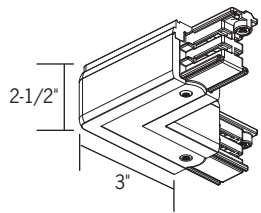

Feedable L-Connector



NTEK34-(B,P,S) 120V
NHTEK34-(B,P,S) 277V

Adjustable Polarity

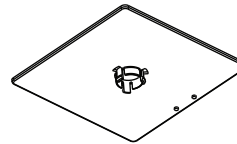

Outlet Box Cover



NGES15-(B,P,S)

120V Fixture Adapter



NTEK70-(B,P,S)

Switchable between circuits and on/off.
 Consult factory for 277V.

Track Length and Field Cutting Tool



NXTSV12

All-in-one hand tool, bends conductors to manufacturer specifications and includes gauge to verify correct length.

Stem Kits



NSPUS12-(B,P) 12" Stem
NSPUS18-(B,P) 18" Stem
NSPUS24-(B,P) 24" Stem
NSPUS48-(B,P) 48" Stem
 Includes stem and canopy.

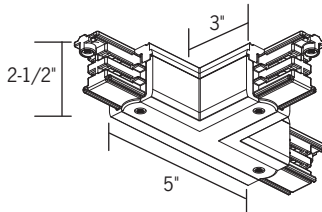

Feedable T-Connectors



NTEK39-(B,P,S) 120V
NHTEK39-(B,P,S) 277V

Feedable T-Connector, Adj. Right Polarity

NTEK40-(B,P,S) 120V
NHTEK40-(B,P,S) 277V

Feedable T-Connector, Adj. Left Polarity

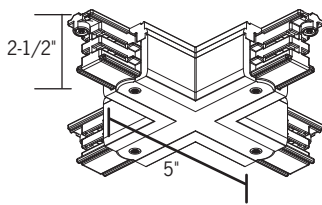
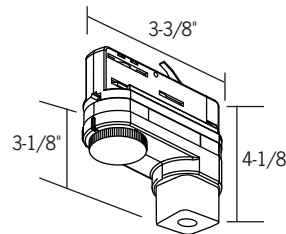

Feedable X-Connector



NTEK38-(B,P,S) 120V
NHTEK38-(B,P,S) 277V

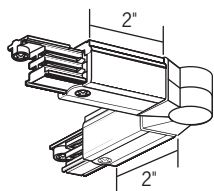

Adjustable Connector



NTEK24-(B,P,S) 120V
NHTEK24-(B,P,S) 277V

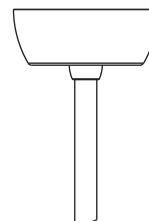
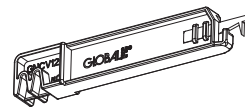

NTEK/NHTEK

2-Circuit/2-Neutral Track Installation Accessories 120V and 277V Series

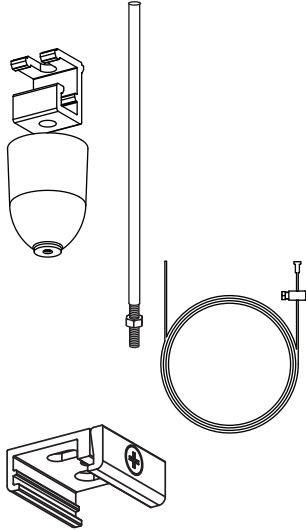

Ceiling Mount Accessories

NSKB30-(B,P,S) Ceiling Cup

For threaded rod or cable mount (rod/cable not included).

NSKB31 Threaded Rod

1/4" Dia., 6' Length. UNLook Finish.

NSKB34 5' Cable

NSKB34/3M 9' Cable

Custom lengths as special order. UNLook Finish.

NSKB12-(B,P,S) Mounting Clip

For threaded rod or cable mount (rod/cable not included).

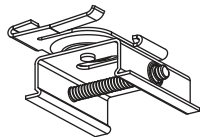

Mounting Clips

NSKBX12-(B,P,S) Deep Tile Mounting Clips

NSKBT12-(B,P,S) Mounting Clips for T-Bar Ceilings

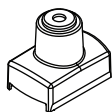

Stem Suspension Points

NSP4P-(B,P,S) Universal Suspension Point

Includes bracket and cover, stem not included. Also works with cable and threaded rod suspension.

Track Dimensions and Configurations

NTEK and NHTEK track are polarized and manufactured with indentifying ridges (dotted line on diagrams). Refer to these diagrams to ensure proper connector selection.

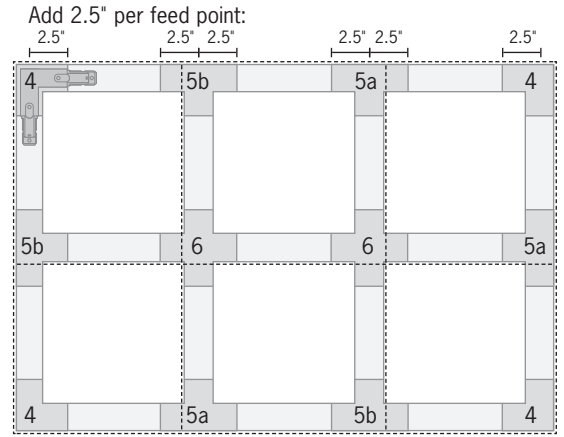

*Actual dimensions or field cut to length

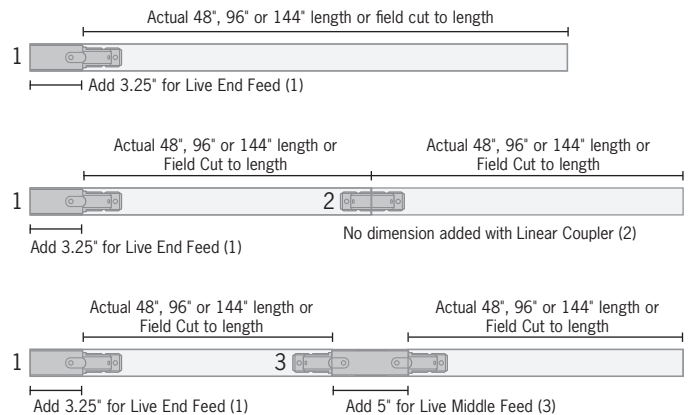
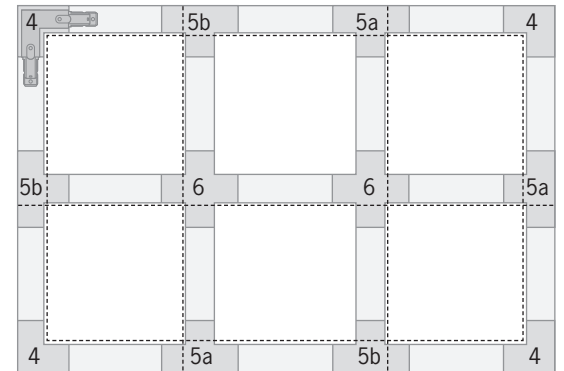

KEY:

- 1 - NTEK11 Live End Feed
- NTEK12 Live End Feed Reverse Polarity
- 2 - NTEK21 Linear Coupler
- 3 - NTEK14 Live Middle Feed
- 4 - NTEK34 Feedable L-Connector Adj. Polarity
- 5a - NTEK39 Feedable T-Connector Adj. Polarity
- 5b - NTEK40 Feedable T-Connector Adj. Left Polarity
- 6 - NTEK38 Feedable X-Connector