

Linear

LiNi-R XL 504

Fixture Guide

KKDC

Indoor | Recessed | Low output up to 510lm/m (155lm/ft)

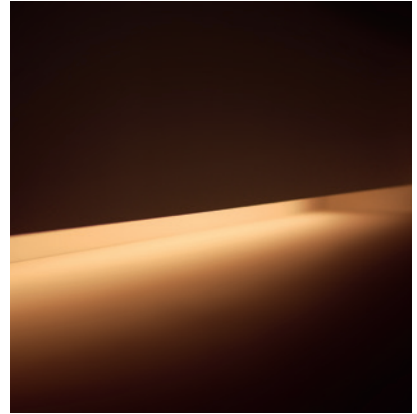

Key applications

- ✓ Ceiling
- ✓ Downlighting
- ✓ Interior
- ✓ Orientation lighting
- ✓ Under cabinet

Key features

- ✓ Custom lengths
- ✓ Diffusion: Homogenous
- ✓ Direct view
- ✓ Extensive CCT range
- ✓ Form factor: Medium
- ✓ IP40
- ✓ Output low

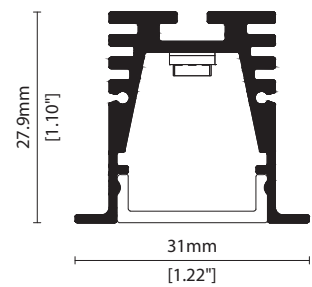

Linear

LiNi-R XL 504

Specification sheet



| | |
|-----------------------|---|
| Dimension | H27.9/W31/L116-2016mm (H1.1/W1.22/L4.57-79.37in) (excluding spring clips) |
| PCB increment | 100mm increment/2000mm max (3.94in increment/78.74in max) |
| LED pitch | 16.7mm - 60LED/m (0.66in - 18LED/ft) |
| Chip | s/e-line Toyoda Gosei k-line Toyoda Gosei or Equivalent |
| Beam angle | 110° (Diffused Cover) |
| Colours | s-line 1900K/2100K/2300K/2500K/2700K/3000K/3500K/4000K/5000K Single colours: Red/Green/Blue/Orange/Amber k-line 1900K/2100K/2300K/2500K/2700K/3000K/3500K/4000K/5000K |
| Bin/Step | s-line 2-step MacAdam ellipse e/k-line 3-step MacAdam ellipse |
| CRI | ≥ 90 |
| Lifetime | 50,000 hours @ 25°C (50,000 hours @ 77°F) |
| Operating temp | T _a = -25 to 60°C (T _c max = 66°C) T _a = -13 to 140°F (T _c max = 150.8°F) |
| IP rating | IP40 |
| Finish | Silver anodised |
| Cover/lens | Diffused |
| Mounting | Recessed mounting via spring clip |
| Power feed | Hardwire tails or male/female connectors |
| Control | 0-10V/1-10V/DMX/DALI |



LED Grading Key

Exclusive Grade

| | | |
|----------------|------------------|-----------------------|
| s-line* | 2-step CCT range | *KKDC tuned CCT range |
| e-line* | 3-step CCT range | |

Base Grade

| | |
|---------------|---|
| k-line | 3-step commercial range Energy Star CCTs |
|---------------|---|

PERFORMANCE DATA @ 3000K

| Power consumption | Supply voltage | Supply current |
|--------------------|----------------|--------------------|
| 12.5W/m (3.81W/ft) | 24V DC | 0.52A/m (0.16A/ft) |

Colour Rendering Index (CRI)

| | R1 | R2 | R3 | R4 | R5 | R6 | R7 | R8 | R9 | R10 | R11 | R12 | R13 | R14 |
|---------------|----|----|----|----|----|----|----|----|----|-----|-----|-----|-----|-----|
| k-line | 94 | 97 | 98 | 93 | 93 | 96 | 92 | 83 | 60 | 93 | 94 | 82 | 95 | 99 |

Diffused Cover

| | | | | CRI | R9 | Rf | Rg |
|-----------------|--------------------|----------|--|-----|----|----|----|
| s/e-line | 510lm/m (155lm/ft) | 41.1lm/W | | 92 | 50 | - | - |
| k-line | 460lm/m (140lm/ft) | 36.5lm/W | | 92 | 60 | - | - |

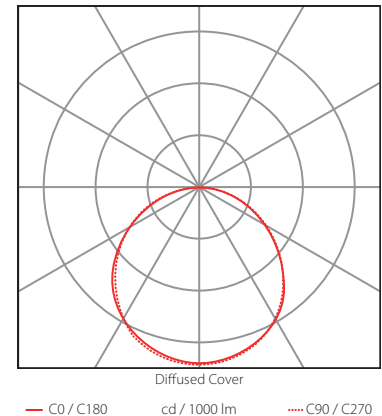
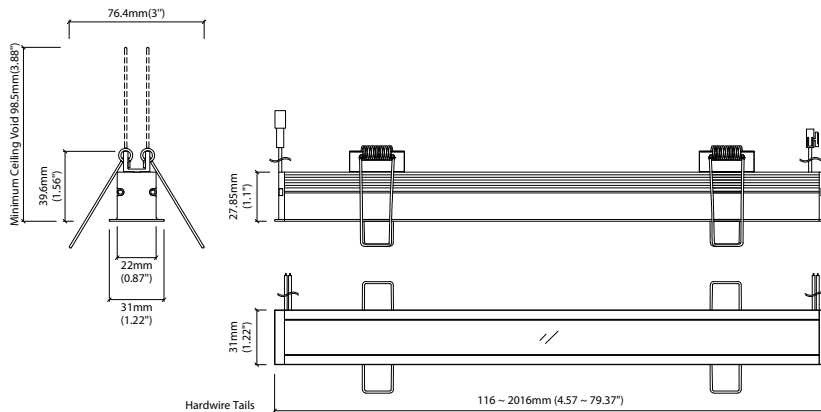

Data derived from independent UKAS / IESNA LM-79-08 accredited testing of production samples.

Linear

LiNi-R XL 504

Code Table

KKDC

FIXTURE

| Model | Finish | Cover | Grade ¹ | LED | Colour (CCT) | Length Availability ² | IP | Cable Length | Power Feed ³ | Input | | | | | | |
|--------------|--------------------|------------|--------------------|-----|----------------|----------------------------------|---------|-------------------|----------------------------|----------|--------------------|----------------------------|-------------------------------------|--------------------------------------|---|--------------------------------------|
| LiNi-R XL RX | Silver Anodised SA | Diffused C | s | 504 | 1900K 19 | m 116-2016mm 100mm increments | IP40 40 | 300mm/11.81" 0300 | Single no sheath tail S00X | DC 24V g | | | | | | |
| | | | | | 2100K 21 | | | | | | 1000mm/39.37" 1000 | Double no sheath tail D00X | | | | |
| | | | | | 2300K 23 | | | | | | | | i 4.57-79.37in 3.94in increments | Single no sheath IP20 connector S20X | | |
| | | | | | 2500K 25 | | | | | | | | | | (Specify length code OR total run length) | Double no sheath IP20 connector D20X |
| | | | | | 2700K 27 | | | | | | | | | | | |
| | | | | | 3000K 30 | | | | | | | | | | | |
| | | | | | 3500K 35 | | | | | | | | | | | |
| | | | | | 4000K 40 | | | | | | | | | | | |
| | | | | | 5000K 50 | | | | | | | | | | | |
| | | | | | RED RED s-only | | | | | | | | | | | |
| | | | | | GREEN GRN | | | | | | | | | | | |
| | | | | | BLUE BLU | | | | | | | | | | | |
| | | | | | ORANGE ORN | | | | | | | | | | | |
| AMBER AMB | | | | | | | | | | | | | | | | |

¹ Refer to **LED Grading Key** on **Specification sheet** page

² Refer to **Length Availability List** or enter total run length instead of length code

³ Refer to **Power Feed Options** on **Options** pages

Code Example:

| | | | | | | | | | | | | | | | | | | | | | | |
|-----------|---|-----------------|---|----------|---|---|---|-----|---|-------|---|-------|---|------|---|--------------|---|-----------------------|---|--------|---|---|
| RX | - | SA | - | C | - | s | - | 504 | - | 35 | - | m | - | 516 | - | 40 | - | 0300 | - | D00X | - | g |
| LiNi-R XL | | Silver Anodised | | Diffused | | s | | 504 | | 3500K | | 516mm | | IP40 | | 300mm/11.81" | | Double no sheath tail | | DC 24V | | |

ACCESSORIES

Connection Accessories

| | |
|---------|---------------------------------------|
| KKCN-01 | 2 PIN male & female 50mm/1.97" pair |
| KKCN-03 | 2 PIN male & female 300mm/11.81" pair |
| KKCN-06 | 2 PIN 300mm/11.81" extension lead |

PSU/Driver

0-10V/1-10V/DALI/DMX

* Refer to **Driver/PSU Options** page for details or provide requirement and KKDC to offer the suitable option

* Refer to **Power feed** on **Accessories** pages

LED ENGINE VARIANTS (LED STRIP TYPE)

| Colour | Output | LED | Lumen/m | Lumen/ft | W/m | W/ft | Spec Doc | Length | Increment |
|------------------------|--------|-----|---|--|-------|------|----------------|-----------------------------|------------------|
| Single CCT | Low | 352 | 190 | 59 | 5.5 | 1.67 | LiNi-R XL 352 | 99.3-2016mm (3.91-79.37in) | 83.3mm (3.28in) |
| | Low | 504 | 510 | 155 | 12.5 | 3.81 | LiNi-R XL 504 | 116-2016mm (4.57-79.37in) | 100mm (3.94in) |
| Warm Dim/Dynamic White | Mid | 508 | 710 | 216 | 17.5 | 5.33 | LiNi-R XL 508 | 87.4-2016mm (3.44-79.37in) | 71.4mm (2.81in) |
| | Max | 040 | 2000 | 610 | 40 | 12.2 | LiNi-R XL A040 | 93-1516mm (3.66-59.68in) | 38.46mm (1.51in) |
| | Low | 207 | 350 | 105 | 10.95 | 3.34 | LiNi-R XL 207 | 99.3-2016mm (3.91-79.37in) | 83.3mm (3.28in) |
| RGB | Mid | 208 | 630 | 213 | 15.6 | 4.75 | LiNi-R XL 208 | 182.7-2016mm (7.19-79.37in) | 166.7mm (6.56in) |
| | | 501 | Red 61 Green 132 Blue 22 RGB 192 | Red 19 Green 40 Blue 7 RGB 59 | 15.6 | 4.75 | LiNi-R XL RGB | 99.3-2016mm (3.91-79.37in) | 83.3mm (3.28in) |

* Performance data: A/s/e-line, diffused cover, 3000K

LiNi-R XL 504

Length Availability List



| Length Code | | Fixture Length ¹ | | LED Strip ² | | End Cap Dimension ³ | | Wattage (W) | Output (lm) | |
|-------------|--------------|-----------------------------|--------------|------------------------|--------------|--------------------------------|--------------|-------------|----------------------|------------|
| Metric | Imperial(US) | Metric | Imperial(US) | Metric | Imperial(US) | Metric | Imperial(US) | | 3000K (Test Data) | Range Data |
| m0116 | i0005 | 116mm | 4.57in | 100mm | 3.94in | 11mm | 0.43in | 1.25 | 51 | 37-53 |
| m0216 | i0009 | 216mm | 8.50in | 200mm | 7.87in | 11mm | 0.43in | 2.50 | 103 | 73-107 |
| m0316 | i0012 | 316mm | 12.44in | 300mm | 11.81in | 11mm | 0.43in | 3.75 | 154 | 110-160 |
| m0416 | i0016 | 416mm | 16.38in | 400mm | 15.75in | 11mm | 0.43in | 5.00 | 206 | 146-214 |
| m0516 | i0020 | 516mm | 20.31in | 500mm | 19.69in | 11mm | 0.43in | 6.25 | 257 | 183-267 |
| m0616 | i0024 | 616mm | 24.25in | 600mm | 23.62in | 11mm | 0.43in | 7.50 | 308 | 219-321 |
| m0716 | i0028 | 716mm | 28.19in | 700mm | 27.56in | 11mm | 0.43in | 8.75 | 360 | 256-374 |
| m0816 | i0032 | 816mm | 32.13in | 800mm | 31.50in | 11mm | 0.43in | 10.00 | 411 | 292-427 |
| m0916 | i0036 | 916mm | 36.06in | 900mm | 35.43in | 11mm | 0.43in | 11.25 | 462 | 329-481 |
| m1016 | i0040 | 1016mm | 40.00in | 1000mm | 39.37in | 11mm | 0.43in | 12.50 | 514 | 365-534 |
| m1116 | i0044 | 1116mm | 43.94in | 1100mm | 43.31in | 11mm | 0.43in | 13.75 | 565 | 402-588 |
| m1216 | i0048 | 1216mm | 47.87in | 1200mm | 47.24in | 11mm | 0.43in | 15.00 | 617 | 438-641 |
| m1316 | i0052 | 1316mm | 51.81in | 1300mm | 51.18in | 11mm | 0.43in | 16.25 | 668 | 475-695 |
| m1416 | i0056 | 1416mm | 55.75in | 1400mm | 55.12in | 11mm | 0.43in | 17.50 | 719 | 511-748 |
| m1516 | i0060 | 1516mm | 59.69in | 1500mm | 59.06in | 11mm | 0.43in | 18.75 | 771 | 548-801 |
| m1616 | i0064 | 1616mm | 63.62in | 1600mm | 62.99in | 11mm | 0.43in | 20.00 | 822 | 584-855 |
| m1716 | i0068 | 1716mm | 67.56in | 1700mm | 66.93in | 11mm | 0.43in | 21.25 | 873 | 621-908 |
| m1816 | i0071 | 1816mm | 71.50in | 1800mm | 70.87in | 11mm | 0.43in | 22.50 | 925 | 657-962 |
| m1916 | i0075 | 1916mm | 75.43in | 1900mm | 74.80in | 11mm | 0.43in | 23.75 | 976 | 694-1015 |
| m2016 | i0079 | 2016mm | 79.37in | 2000mm | 78.74in | 11mm | 0.43in | 25.00 | 1028 | 730-1069 |

¹ Actual total overall length of light fixture (LED strip + end caps + void/wire hole)

² Actual length of PCB strip

³ Actual length of 2x end caps

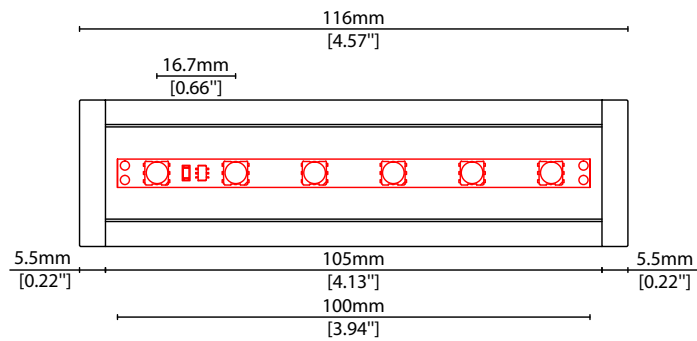



LiNi-R XL 504

Options



COVER/LENS OPTIONS

* Options are an integral part of the fixture ordering codes. Please refer to **Code Table** pages.

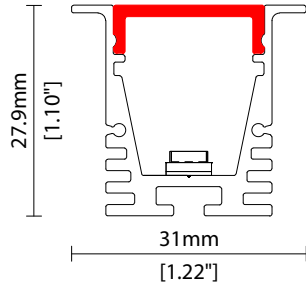
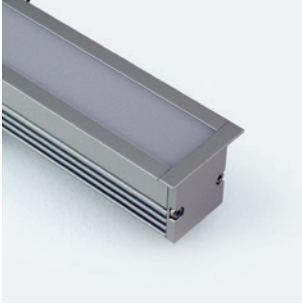

C Diffused cover
W31/H27.9mm (W1.22/H1.10")

POWER FEED OPTIONS

0300 S00X 300mm (11.81") Single no sheath tail

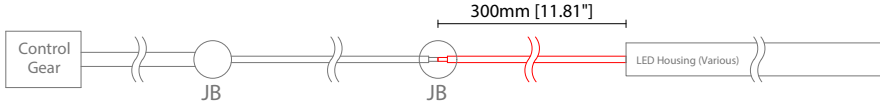

0300 D00X 300mm (11.81") Double no sheath tail

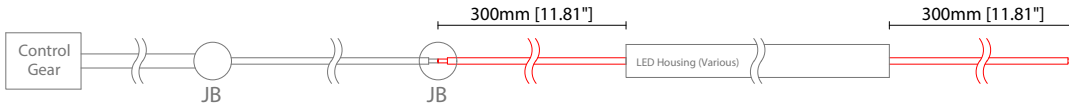

0300 S20X 300mm (11.81") Single no sheath IP20 connector

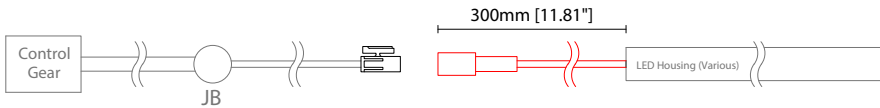

0300 D20X 300mm (11.81") Double no sheath IP20 connector

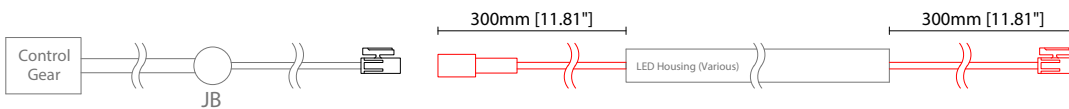

1000 S00X 1000mm (39.37") Single no sheath tail

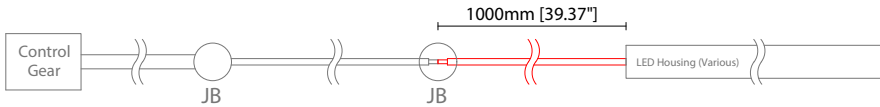

1000 D00X 1000mm (39.37") Double no sheath tail

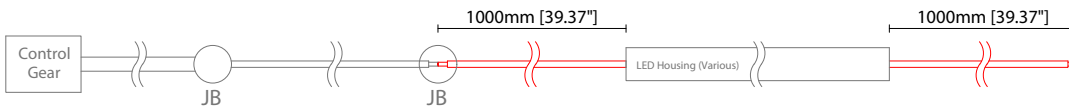

1000 S20X 1000mm (39.37") Single no sheath IP20 connector

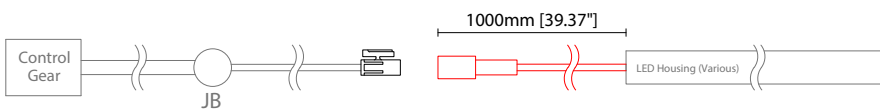

1000 D20X 1000mm (39.37") Double no sheath IP20 connector

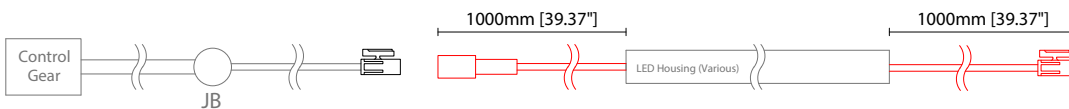

Key

Control Gear Power supply, sub-controllers & control systems
 JB Junction box / cable connection

Linear

LiNi-R XL 504 Options



POWER FEED OPTIONS (CONTINUED)

2 Pin Female Connector

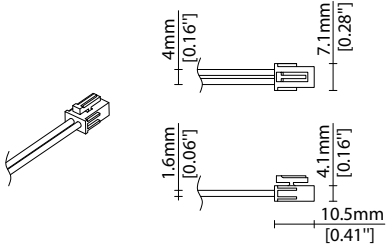

2 Pin Male Connector

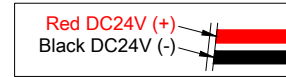
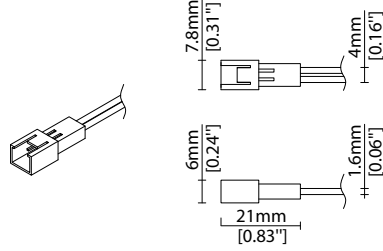

POWER FEED

Note: Accessories are to be ordered separately with corresponding code shown below.

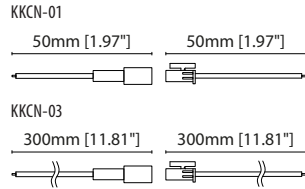
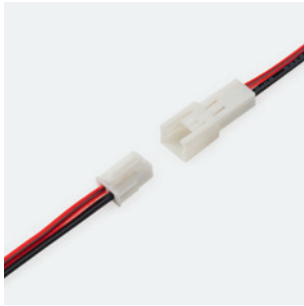

KKCN-01 50mm (1.97in) pair
KKCN-03 300mm (11.81in) pair
 2 PIN male + female connector set

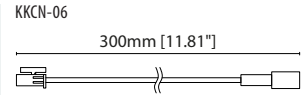

KKCN-06
 2 PIN 300mm (11.81in) extension lead

KKDC CONTROL



IP20
 Plastic housing
 L170/W59/H29mm
 (L6.69/W2.32/H1.14in)

KKDM-06 1-10V
 visDIM dimmable sub-controller
 (4 x 8A max @ 12-36V)



IP20
 Plastic housing
 L170/W53.4/H28mm
 (L6.69/W2.10/H1.10in)

KKSC-05 DMX
 visDIM dimmable sub-controller
 (4 x 5A max @ 12-36V)



IP20
 Plastic housing
 L170/W59/H29mm
 (L6.69/W2.32/H1.14in)

KKDL-02 DALI
 visDIM dimmable sub-controller
 (4 x 8A max @ 12-36V)



IP20
 Plastic housing
 L166/W53.4/H23mm
 (L6.54/W2.10/H0.91in)

KKDL-03 DALI
 visDIM dimmable sub-controller
 (4 x 5A max @ 12-36V)

AVAILABLE PSU OPTIONS

| Control Mode | PSU (Order Code) | Input Voltage AC | Output Voltage DC | Rated Output Current | Rated Power | Dim % | IP Rating |
|---------------|------------------|------------------|-------------------|----------------------|-------------|-------------------|-----------|
| Switched | CEN-60-24 | 90-295V | 24V | 2.5A | 60W | - | IP67 |
| | HLG-60H-24 | 90-305V | 24V | 2.5A | 60W | - | IP67 |
| | HLG-100H-24 | 90-305V | 24V | 4.0A | 100W | - | IP67 |
| | HLG-150H-24 | 90-305V | 24V | 6.3A | 150W | - | IP67 |
| | HLG-240H-24 | 90-305V | 24V | 10A | 240W | - | IP67 |
| 0-10V (1-10V) | PWM-40-24 | 90-305V | 24V | 1.67A | 40W | 100-0.15 (100-10) | IP67 |
| | PWM-60-24 | 90-305V | 24V | 2.5A | 60W | 100-0.15 (100-10) | IP67 |
| | PWM-90-24 | 90-305V | 24V | 3.67A | 90W | 100-0.15 (100-10) | IP67 |
| | PWM-120-24 | 90-305V | 24V | 5.0A | 120W | 100-0.15 (100-10) | IP67 |
| DALI | LIN100A1 | 120-277V | 24V | 1A per channel | 100W | 100-0.1 | IP66/IP40 |
| DMX RGB | LIN100A1 | 120-277V | 24V | 1.33A per channel | 100W | 100-0.1 | IP66/IP40 |
| DMX RGBW | LIN100A1 | 120-277A | 24V | 1A per channel | 100W | 100-0.1 | IP66/IP40 |

Flicker Free Options - Combination of PSU+ sub-controller

| Control Mode | PSU (Order Code) | Sub-controller (Order Code) | Input Voltage AC | Output Voltage DC | Rated Output Current | Rated Power | Dim % | IP Rating PSU/ Sub-controller |
|----------------|------------------|-----------------------------|------------------|-------------------|----------------------|-------------|---------|-------------------------------|
| 0-10V or 1-10V | CEN-60-24 | KKDM-06 | 90-295V | 24V | 2.5A | 60W | 100-0.9 | IP67/IP20 |
| | HLG-60H-24 | KKDM-06 | 90-295V | 24V | 2.5A | 60W | 100-0.9 | IP67/IP20 |
| | HLG-100H-24 | KKDM-06 | 90-295V | 24V | 4.0A | 100W | 100-0.9 | IP67/IP20 |
| | HLG-150H-24 | KKDM-06 | 90-295V | 24V | 6.3A | 150W | 100-0.9 | IP67/IP20 |
| | HLG-240H-24 | KKDM-06 | 90-295V | 24V | 10.0A | 240W | 100-0.9 | IP67/IP20 |
| DALI | CEN-60-24 | KKDL-02/03 | 90-295V | 24V | 2.5A | 60W | 100-0.1 | IP67/IP20 |
| | HLG-60H-24 | KKDL-02/03 | 90-305V | 24V | 2.5A | 60W | 100-0.1 | IP67/IP20 |
| | HLG-100H-24 | KKDL-02/03 | 90-305V | 24V | 4.0A | 100W | 100-0.1 | IP67/IP20 |
| | HLG-150H-24 | KKDL-02/03 | 90-305V | 24V | 6.3A | 150W | 100-0.1 | IP67/IP20 |
| | HLG-240H-24 | KKDL-02/03 | 90-305V | 24V | 10.0A | 240W | 100-0.1 | IP67/IP20 |
| DMX RGB | CEN-60-24 | KKSC-05 | 90-295V | 24V | 2.5A | 60W | 100-0.9 | IP67/IP20 |
| | HLG-60H-24 | KKSC-05 | 90-305V | 24V | 2.5A | 60W | 100-0.9 | IP67/IP20 |
| | HLG-100H-24 | KKSC-05 | 90-305V | 24V | 4A | 100W | 100-0.9 | IP67/IP20 |
| | HLG-150H-24 | KKSC-05 | 90-305V | 24V | 6.3A | 150W | 100-0.9 | IP67/IP20 |
| | HLG-240H-24 | KKSC-05 | 90-305V | 24V | 10.0A | 240W | 100-0.9 | IP67/IP20 |

¹ The items shown above cover the most frequently used specification but does not exhaust the possible options

² PSU and/or driver can be chosen from the table, or KKDC may recommend the best option upon receipt of the controls requirement and installation environment

³ Electrical shop drawing will include detailed information of PSU and relevant control drivers

⁴ Cut sheets are available on the controls section of www.kkdc.lighting or upon request