

Linear

MoMo Sauna 508A Fixture Guide

KKDÖ

Indoor/Outdoor | Surface | Low output up to 140lm/m (43lm/ft)

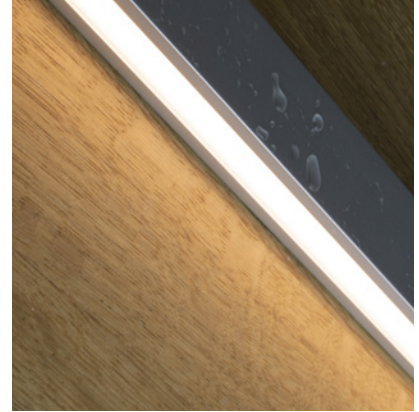
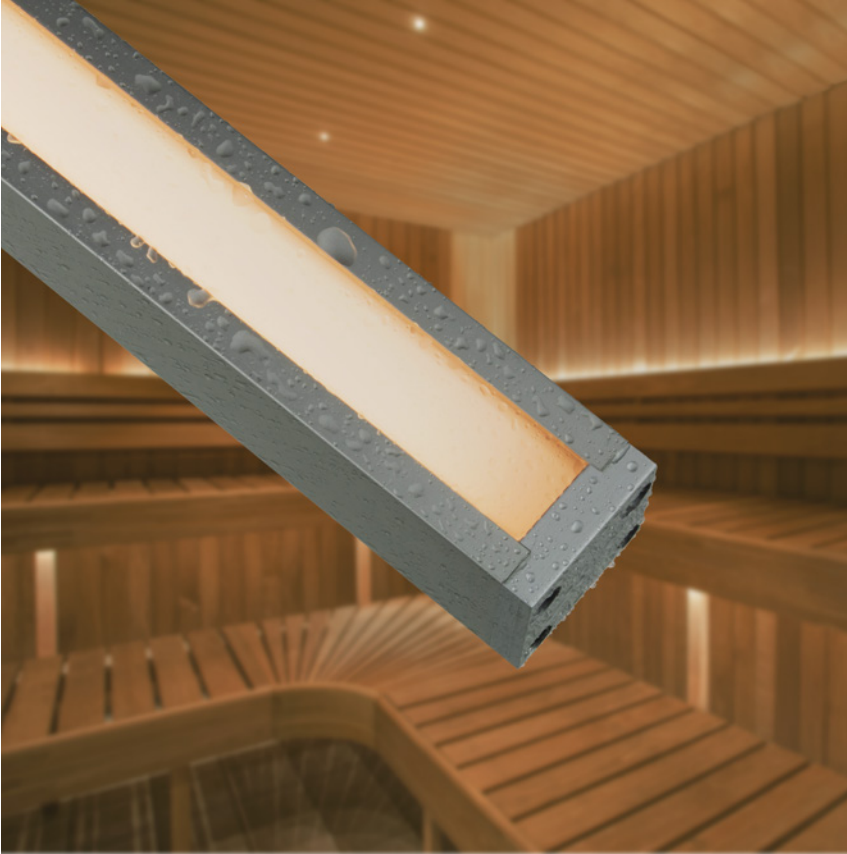

Key applications

- ✓ Bathrooms
- ✓ Building façades
- ✓ Interior/Exterior
- ✓ Mirror back lighting
- ✓ Public spaces
- ✓ Retail display
- ✓ Under bench
- ✓ Wall grazing
- ✓ Window reveal

Key features

- ✓ Custom lengths
- ✓ Diffusion: Homogenous
- ✓ Direct view
- ✓ Extensive CCT range
- ✓ Form factor: Medium
- ✓ IP67
- ✓ Output low

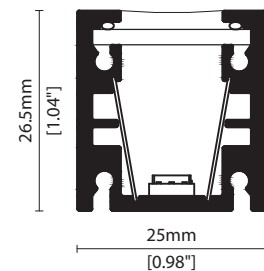

MOUNTING METHODS

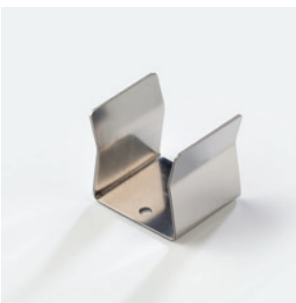

KKCP-03 Clip



KKCP-09 Lock clip



KKBK-07 Fixing plate



KKBK-21 Adjustable bracket

Linear

MoMo Sauna 508A

Specification sheet

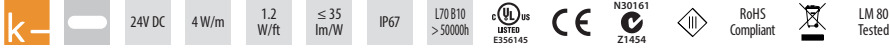

Dimension	H26.5/W25/L101.4-2030mm (H1.04/W0.98/L3.99-79.92in)
PCB increment	71.4mm increment/2000mm max (2.81in increment/78.74in max)
LED pitch	11.9mm - 84LED/m (0.47in - 26LED/ft)
Chip	k-line Toyoda Gosei or Equivalent
Beam angle	95° (Diffused Cover)
Colours	k-line 2700K
Bin/Step	k-line 3-step MacAdam ellipse
CRI	≥ 90
Lifetime	33,000 hours @ 100°C (33,000 hours @ 212°F)
Operating temp	Dry sauna; Ta=-25 to 100°C (T _c max =105°C), RH 20% [US data] Steam room; Ta=-25 to 70°C (T _c max =105°C), RH 100% [US data]
IP rating	IP67
Finish	Silver anodised
Cover/lens	Diffused
Mounting	Surface mounting via clips or brackets
Power feed	Double sheathed tail
Control	0-10V/1-10V/DMX/DALI



LED Grading Key

Base Grade

k-line
3-step commercial range
Energy Star CCTs

PERFORMANCE DATA @ 2700K

Power Consumption	Supply voltage	Supply current
4W/m (1.2W/ft)	24V DC	0.17A/m (0.05A/ft)

Colour Rendering Index (CRI)

	R1	R2	R3	R4	R5	R6	R7	R8	R9	R10	R11	R12	R13	R14
k-line	94	97	98	93	93	96	92	83	60	93	94	82	95	99

Diffused Cover				CRI	R9	Rf	Rg
k-line	140lm/m (43lm/ft)	35lm/W		92	60	-	-

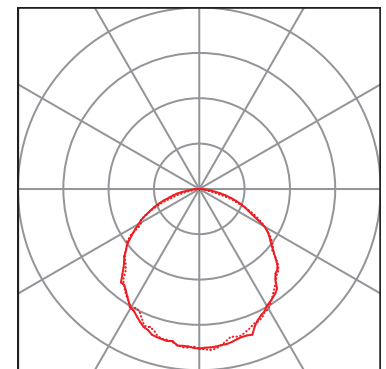
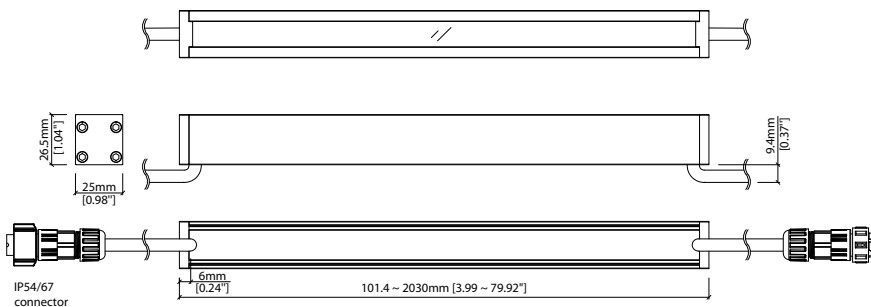

— C0 / C180 cd / 1000 lm - - - C90 / C270

Data derived from production samples tested to UKAS/IESNA LM-79-08 standards

See KKDC website for product document updates.

www.kkdc.lighting

MoMoSauna508AS-02.04EN-20220809

MoMo Sauna 508A

Code Table



FIXTURE

Model	Finish	Cover ¹	Grade ²	LED	Colour (CCT)	Length Availability ³	IP	Cable Length	Power Feed ⁴	Input										
MoMo Sauna	MS	Silver Anodised	SA	Clear	B	k	k	508A	2700K	27	m	101.4-2030mm 71.4mm increments	IP67	67	300mm/11.81"	0300	Single ø6.3mm sheath IP67 connector	S67B	DC 24V	g
				Diffused	C						i	3.99-79.92in 2.81in increments					Double ø6.3mm sheath IP67 connector	D67B		
											(Specify length code OR total run length)									

¹ Refer to **Cover/Lens Options** on **Options** pages

² Refer to **LED Grading Key** on **Specification sheet** page

³ Refer to **Length Availability List** or enter total run length instead of length code

⁴ Refer to **Power feed Options** on **Options** pages

Code Example:

MS	-	SA	-	C	-	k	-	508A	-	27	-	m	530	-	67	-	0300	-	D67B	-	g
MoMo Sauna		Silver Anodised		Diffused		k		508 (Sauna, 4W)		2700K		529.8mm		IP67		300mm/11.81"		Double ø6.3mm sheath IP67 connector		DC 24V	

ACCESSORIES

Mounting Accessories

KKCP-03	Clip (1no.)
KKCP-53	Clip (500no.)
KKCP-09	Lock Clip
KKBK-07	Fixing plate
KKBK-21	Adjustable bracket

* Refer to **Mounting accessories** on **Accessories** pages

Connection Accessories

CN67-2P-0300	IP67 2 PIN male & female 300mm/11.81" pair
CN67-2P-1000	IP67 2 PIN male & female 1000mm/39.37" pair
CN67-2P-3000	IP67 2 PIN male & female 3000mm/118.11" pair

* Refer to **Power feed** on **Accessories** pages

Exterior Junction Boxes

KKJB-07	IP67 Slim J-Box
KKJB-07R	Potting Resin for IP67 Slim J-Box

* Refer to **Exterior Junction Boxes** on **Accessories** pages

PSU/Driver

0-10V/1-10V/DALI/DMX

* Refer to **Driver/PSU Options** page for details or provide requirement and KKDC to offer the suitable option

LED ENGINE VARIANTS (LED STRIP TYPE)

Colour	Output	LED	Lumen/m	Lumen/ft	W/m	W/ft	Spec Doc	Length	Increment
Single CCT	Low	508A	140	43	4	1.2	MoMo Sauna 508A	101.4-2030mm (3.99-79.92in)	71.4mm (2.81in)
	Low	A008	384	117	8	2.44	MoMo Sauna A008	107-2030mm (4.21-79.92in)	38.46mm (1.51in)

* Performance data: A/k-line, diffused cover, 2700K

MoMo Sauna 508A

Length Availability List



Length Code		Fixture Length ¹		LED Strip ²		End Cap Dimension ³		Wattage (W)	Output (lm)
Metric	Imperial(US)	Metric	Imperial(US)	Metric	Imperial(US)	Metric	Imperial(US)		2700K (Test Data)
m0101	i0004	101mm	3.99in	71mm	2.81in	10mm	0.39in	0.29	10
m0173	i0007	173mm	6.81in	143mm	5.62in	10mm	0.39in	0.57	20
m0244	i0010	244mm	9.62in	214mm	8.44in	10mm	0.39in	0.86	30
m0316	i0012	316mm	12.43in	286mm	11.25in	10mm	0.39in	1.14	40
m0387	i0015	387mm	15.24in	357mm	14.06in	10mm	0.39in	1.43	50
m0459	i0018	459mm	18.05in	429mm	16.87in	10mm	0.39in	1.72	60
m0530	i0021	530mm	20.87in	500mm	19.69in	10mm	0.39in	2.00	70
m0601	i0024	601mm	23.68in	571mm	22.50in	10mm	0.39in	2.29	80
m0673	i0026	673mm	26.49in	643mm	25.31in	10mm	0.39in	2.57	90
m0744	i0029	744mm	29.30in	714mm	28.12in	10mm	0.39in	2.86	100
m0816	i0032	816mm	32.12in	786mm	30.93in	10mm	0.39in	3.15	110
m0887	i0035	887mm	34.93in	857mm	33.75in	10mm	0.39in	3.43	120
m0959	i0038	959mm	37.74in	929mm	36.56in	10mm	0.39in	3.72	130
m1030	i0041	1030mm	40.55in	1000mm	39.37in	10mm	0.39in	4.00	140
m1101	i0043	1101mm	43.36in	1071mm	42.18in	10mm	0.39in	4.29	150
m1173	i0046	1173mm	46.18in	1143mm	45.00in	10mm	0.39in	4.58	160
m1244	i0049	1244mm	48.99in	1214mm	47.81in	10mm	0.39in	4.86	170
m1316	i0052	1316mm	51.80in	1286mm	50.62in	10mm	0.39in	5.15	180
m1387	i0055	1387mm	54.61in	1357mm	53.43in	10mm	0.39in	5.43	190
m1459	i0057	1459mm	57.43in	1429mm	56.24in	10mm	0.39in	5.72	200
m1530	i0060	1530mm	60.24in	1500mm	59.06in	10mm	0.39in	6.01	210
m1601	i0063	1601mm	63.05in	1571mm	61.87in	10mm	0.39in	6.29	220
m1673	i0066	1673mm	65.86in	1643mm	64.68in	10mm	0.39in	6.58	230
m1744	i0069	1744mm	68.67in	1714mm	67.49in	10mm	0.39in	6.86	240
m1816	i0071	1816mm	71.49in	1786mm	70.31in	10mm	0.39in	7.15	250
m1887	i0074	1887mm	74.30in	1857mm	73.12in	10mm	0.39in	7.44	260
m1959	i0077	1959mm	77.11in	1929mm	75.93in	10mm	0.39in	7.72	270
m2030	i0080	2030mm	79.92in	2000mm	78.74in	10mm	0.39in	8.01	280

¹ Actual total overall length of light fixture (LED strip + end caps + void/wire hole)

² Actual length of PCB strip

³ Actual length of 2x end caps

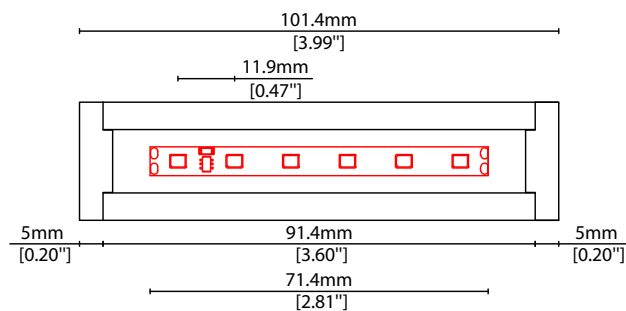

Linear

MoMo Sauna 508A Options

KKDÖ

COVER/LENS OPTIONS

* Options are an integral part of the fixture ordering codes. Please refer to **Code Table** pages.



B Clear Cover

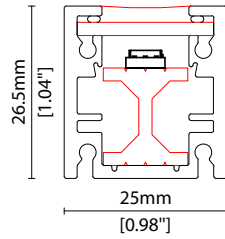

C Diffused Cover

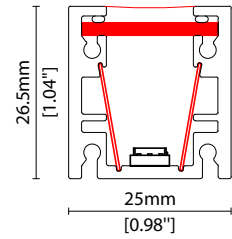

POWER FEED OPTIONS

* Options are an integral part of the fixture ordering codes. Please refer to **Code Table** pages.

0300 S67B 300mm (11.81") Single Ø6.3mm sheath IP67 connector

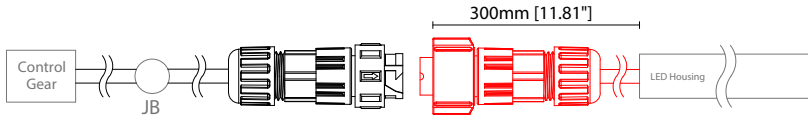

0300 D67B 300mm (11.81") Double Ø6.3mm sheath IP67 connector

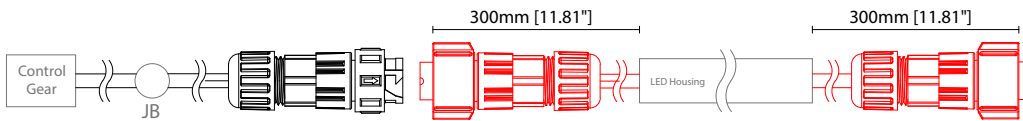

IP67 2 Pin Connector

Female connector
2 PIN (IP67)

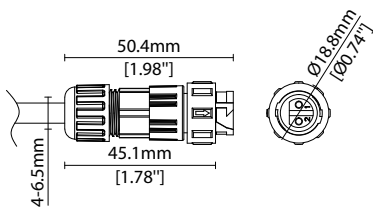

Male connector
2 PIN (IP67)

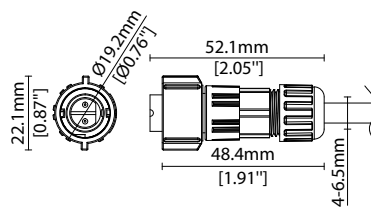

Key

- Control Gear Power supply, sub-controllers & control systems
- JB Junction box / cable connection

MOUNTING ACCESSORIES

Note: Accessories are to be ordered separately with corresponding code shown below.

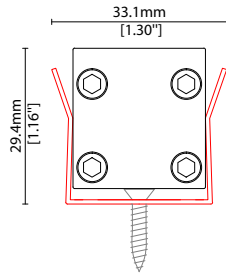

KKCP-03 (1no.)
KKCP-53 (500no.)
 Clip (allow 3 per metre/40in)
 S/Steel finish
 L25/W33.1/H29.4mm
 (L0.98/W1.3/H1.16")

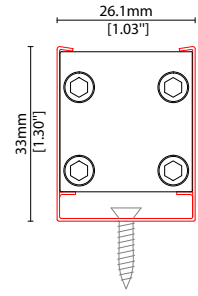

KKCP-09
 Lock clip (allow 2 per metre/40in)
 S/Steel finish
 L25/W26.1/H33mm
 (L0.98/W1.03/H1.3")

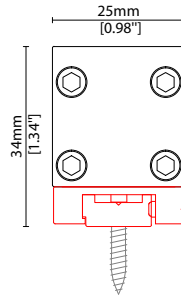

KKBK-07
 Fixing plate (allow 2 per metre/40in)
 Anodised aluminium finish
 L50/W25/H34mm
 (L1.97/W0.98/H1.34")
 Pre-assembled in factory

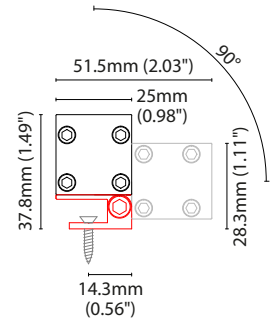

KKBK-21
 Adjustable bracket
 (allow 2 per metre/40in)
 Anodised aluminium finish
 L34/W25/H37.8mm
 (L1.34/W0.98/H1.49")
 Pre-assembled in factory

POWER FEED

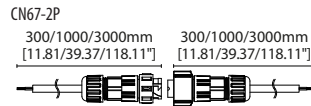

CN67-2P-0300 300mm (11.81in) pair
CN67-2P-1000 1000mm (39.37in) pair
CN67-2P-3000 3000mm (118.11in) pair
 IP67
 2 PIN male + female connector set

EXTERIOR JUNCTION BOXES



KKJB-07

IP67 Slim J-Box
(including type A,B,C, D bushings)



KKJB-07R

Potting resin for IP67 Slim J-Box

KKDC CONTROL



KKDM-06 1-10V

visDIM dimmable sub-controller
(4 x 8A max @ 12-36V)

IP20
Plastic housing
L170/W59/H29mm
(L6.69/W2.32/H1.14in)



KKSC-05 DMX

visDIM dimmable sub-controller
(4 x 5A max @ 12-36V)

IP20
Plastic housing
L170/W53.4/H28mm
(L6.69/W2.10/H1.10in)



KKDL-02 DALI

visDIM dimmable sub-controller
(4 x 8A max @ 12-36V)

IP20
Plastic housing
L170/W59/H29mm
(L6.69/W2.32/H1.14in)



KKDL-03 DALI

visDIM dimmable sub-controller
(4 x 5A max @ 12-36V)

IP20
Plastic housing
L166/W53.4/H23mm
(L6.54/W2.10/H0.91in)

AVAILABLE PSU OPTIONS

Control Mode	PSU (Order Code)	Input Voltage AC	Output Voltage DC	Rated Output Current	Rated Power	Dim %	IP Rating
Switched	CEN-60-24	90-295V	24V	2.5A	60W	-	IP67
	HLG-60H-24	90-305V	24V	2.5A	60W	-	IP67
	HLG-100H-24	90-305V	24V	4.0A	100W	-	IP67
	HLG-150H-24	90-305V	24V	6.3A	150W	-	IP67
	HLG-240H-24	90-305V	24V	10A	240W	-	IP67
0-10V (1-10V)	PWM-40-24	90-305V	24V	1.67A	40W	100-0.15 (100-10)	IP67
	PWM-60-24	90-305V	24V	2.5A	60W	100-0.15 (100-10)	IP67
	PWM-90-24	90-305V	24V	3.67A	90W	100-0.15 (100-10)	IP67
	PWM-120-24	90-305V	24V	5.0A	120W	100-0.15 (100-10)	IP67
DALI	LIN100A1	120-277V	24V	1A per channel	100W	100-0.1	IP66/IP40
DMX RGB	LIN100A1	120-277V	24V	1.33A per channel	100W	100-0.1	IP66/IP40
DMX RGBW	LIN100A1	120-277A	24V	1A per channel	100W	100-0.1	IP66/IP40

Flicker Free Options - Combination of PSU+ sub-controller

Control Mode	PSU (Order Code)	Sub-controller (Order Code)	Input Voltage AC	Output Voltage DC	Rated Output Current	Rated Power	Dim %	IP Rating PSU/ Sub-controller
0-10V or 1-10V	CEN-60-24	KKDM-06	90-295V	24V	2.5A	60W	100-0.9	IP67/IP20
	HLG-60H-24	KKDM-06	90-295V	24V	2.5A	60W	100-0.9	IP67/IP20
	HLG-100H-24	KKDM-06	90-295V	24V	4.0A	100W	100-0.9	IP67/IP20
	HLG-150H-24	KKDM-06	90-295V	24V	6.3A	150W	100-0.9	IP67/IP20
	HLG-240H-24	KKDM-06	90-295V	24V	10.0A	240W	100-0.9	IP67/IP20
DALI	CEN-60-24	KKDL-02/03	90-295V	24V	2.5A	60W	100-0.1	IP67/IP20
	HLG-60H-24	KKDL-02/03	90-305V	24V	2.5A	60W	100-0.1	IP67/IP20
	HLG-100H-24	KKDL-02/03	90-305V	24V	4.0A	100W	100-0.1	IP67/IP20
	HLG-150H-24	KKDL-02/03	90-305V	24V	6.3A	150W	100-0.1	IP67/IP20
	HLG-240H-24	KKDL-02/03	90-305V	24V	10.0A	240W	100-0.1	IP67/IP20
DMX RGB	CEN-60-24	KKSC-05	90-295V	24V	2.5A	60W	100-0.9	IP67/IP20
	HLG-60H-24	KKSC-05	90-305V	24V	2.5A	60W	100-0.9	IP67/IP20
	HLG-100H-24	KKSC-05	90-305V	24V	4A	100W	100-0.9	IP67/IP20
	HLG-150H-24	KKSC-05	90-305V	24V	6.3A	150W	100-0.9	IP67/IP20
	HLG-240H-24	KKSC-05	90-305V	24V	10.0A	240W	100-0.9	IP67/IP20

¹ The items shown above cover the most frequently used specification but does not exhaust the possible options

² PSU and/or driver can be chosen from the table, or KKDC may recommend the best option upon receipt of the controls requirement and installation environment

³ Electrical shop drawing will include detailed information of PSU and relevant control drivers

⁴ Cut sheets are available on the controls section of www.kkdc.lighting or upon request