

TIGER SOA LED

Architectural Indoor



PROJECT:	
TYPE:	
PO#:	QTY:
COMMENTS:	



FEATURES

- ADA Compliant
- Centered Over and Mounted to 4" J-Box (By Others)
- CSA Listed Dry Location For Wall Mount
- Dimmable to 10%
- Luminous White Acrylic Diffuser
- Mounting Hardware Included
- Open Top and Bottom
- Optional Surge Protector
- Steel Fascia with Matte Silver Powder Coat Finish
- Steel Mounting Plate Mounts to Flat Surface

LINE DRAWING

LINE DRAWING NOT TO SCALE

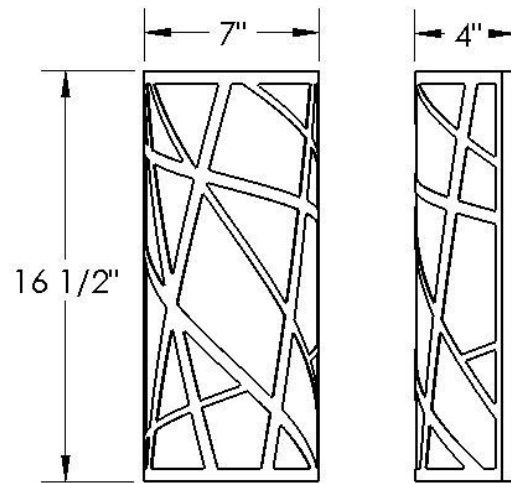

FINISHES

Antique Copper



Antique Silver



Bronze Mist



Matte Silver

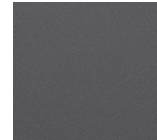

Sand

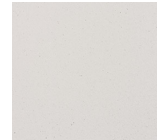

Swedish Steel

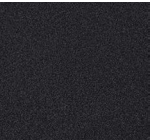

Textured Black

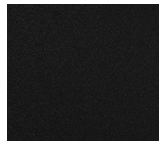

Textured Bronze

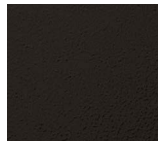

Textured White

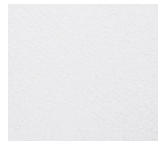

For RAL Colors & Custom Match - Contact Teron Lighting Inc.

TIGER SOA LED

Architectural Indoor



Fixture Core

PROJECT:	
TYPE:	
PO#:	QTY:
COMMENTS:	

PRODUCT CODE	SOURCE/WATTAGE	VOLTAGE	DIMMING DRIVER
TGR - Tiger	L12.0-LT350 - 12.0W LED Strips @ 350mA 2-Wire Trailing or Leading Edge Driver L12.0-ZE350 - 12.0W LED Strips @ 350mA Low Voltage 4-Wire Dimming Electronic Driver	120-277V (120-230V Dimmable For Most LT LED Drivers) (ZE 0-10V Drivers Are Dimmable From 120V - 277V)	Not Applicable
ORDER INFO			
TGR Example ^	L12.0-LT350	100-277V	Not Applicable

Aesthetics & Options

TRIM	FINISH	COLOR TEMP	OPTIONS
SOA	AC - Antique Copper TB - Textured Black AS - Antique Silver BT - Bronze Mist BZ - Textured Bronze SM - Matte Silver (Standard) TW - Textured White SN - Sand SW - Swedish Steel	30K - 3000K Color Temp 35K - 3500K Color Temp 40K - 4000K Color Temp 50K - 5000K Color Temp	F - Fused S - Surge Protector TBC - Perforated Steel Top & Bottom Covers TCV - Perforated Steel Top Cover
ORDER INFO			
SOA Example ^	AC	30K	F

PROD	SOURCE	30K SPECS				
TGR	L12.0	<ul style="list-style-type: none"> 30K - 3000K Color Temp 1400 LED Source Lumens 116.7 LED Source Lumens Per Watt 				
	L18.0	<ul style="list-style-type: none"> 30K - 3000K Color Temp 1986 LED Source Lumens 110.3 LED Source Lumens Per Watt 				

REPLACEMENT PART	PART NO	NOTES
White Acrylic Lens	3040960	

Don't see the configuration you are looking for?
Call us today at (513) 858-6004



TERONLIGHTING.COM
 33 DONALD DR, FAIRFIELD, OH 45014
 P: 513.858.6004 F: 513.858.6038
 E: SALES@TERONLIGHT.COM



We reserve the right to revise the design components of any product due to parts availability or change in UL standards, without assuming any obligation or liability to modify any products previously manufactured, and without notice.

TIGER SOA LED

Architectural Indoor



Fixture Core

PROJECT:	
TYPE:	
PO#:	QTY:
COMMENTS:	

PRODUCT CODE	SOURCE/WATTAGE	VOLTAGE	DIMMING DRIVER
TGR - Tiger	L18.0-LT500 - 18.0W LED Strips @ 500mA 2-Wire Trailing or Leading Edge Driver L18.0-ZE500 - 18.0W LED Strips @ 500mA Low Voltage 4-Wire Dimming Electronic Driver	120-277V (120-230V Dimmable For Most LT LED Drivers) (ZE 0-10V Drivers Are Dimmable From 120V - 277V)	Not Applicable
ORDER INFO			
TGR Example ^	L18.0-ZE500	100-277V	Not Applicable

Aesthetics & Options

TRIM	FINISH	COLOR TEMP	OPTIONS
SOA	AC - Antique Copper TB - Textured Black AS - Antique Silver BT - Bronze Mist BZ - Textured Bronze SM - Matte Silver (Standard) TW - Textured White SN - Sand SW - Swedish Steel	30K - 3000K Color Temp 35K - 3500K Color Temp 40K - 4000K Color Temp 50K - 5000K Color Temp	F - Fused S - Surge Protector TBC - Perforated Steel Top & Bottom Covers TCV - Perforated Steel Top Cover
ORDER INFO			
SOA Example ^	AC	30K	F

PROD	SOURCE	30K SPECS				
TGR	L18.0	<ul style="list-style-type: none"> 30K - 3000K Color Temp 1986 LED Source Lumens 110.3 LED Source Lumens Per Watt 				

REPLACEMENT PART	PART NO	NOTES
White Acrylic Lens	3040960	

Don't see the configuration you are looking for?
Call us today at (513) 858-6004



TERONLIGHTING.COM
 33 DONALD DR, FAIRFIELD, OH 45014
 P: 513.858.6004 F: 513.858.6038
 E: SALES@TERONLIGHT.COM



We reserve the right to revise the design components of any product due to parts availability or change in UL standards, without assuming any obligation or liability to modify any products previously manufactured, and without notice.

TIGER SOA LED

Architectural Indoor



Fixture Core

PROJECT:	
TYPE:	
PO#:	QTY:
COMMENTS:	

PRODUCT CODE	SOURCE/WATTAGE	VOLTAGE	DIMMING DRIVER
TGR - Tiger	L18.0-ZE500 - 18.0W LED Strips @ 500mA Low Voltage 4-Wire Dimming Electronic Driver	347V (ZE 0-10V Drivers are Dimmable @ 347V)	Dimmable 0-10V
ORDER INFO			
TGR Example ^	L18.0-ZE500	347V	Not Applicable

Aesthetics & Options

TRIM	FINISH	COLOR TEMP	OPTIONS
SOA	AC - Antique Copper AS - Antique Silver BT - Bronze Mist SM - Matte Silver (Standard) SN - Sand SW - Swedish Steel TB - Textured Black BZ - Textured Bronze TW - Textured White	30K - 3000K Color Temp 35K - 3500K Color Temp 40K - 4000K Color Temp 50K - 5000K Color Temp	S - Surge Protector TBC - Perforated Steel Top & Bottom Covers TCV - Perforated Steel Top Cover
ORDER INFO			
SOA Example ^	AC	30K	F

PROD	SOURCE	30K SPECS			
TGR	L18.0	<ul style="list-style-type: none"> 30K - 3000K Color Temp 1986 LED Source Lumens 110.3 LED Source Lumens Per Watt 			

REPLACEMENT PART	PART NO	NOTES
White Acrylic Lens	3040960	
		Don't see the configuration you are looking for? Call us today at (513) 858-6004



TERONLIGHTING.COM
 33 DONALD DR, FAIRFIELD, OH 45014
 P: 513.858.6004 F: 513.858.6038
 E: SALES@TERONLIGHT.COM



We reserve the right to revise the design components of any product due to parts availability or change in UL standards, without assuming any obligation or liability to modify any products previously manufactured, and without notice.