

4DS dim to WARM

4.5" Downlight – Square

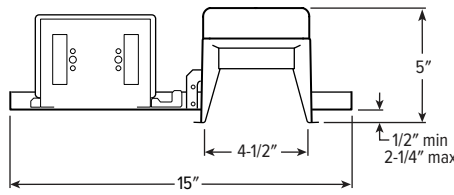
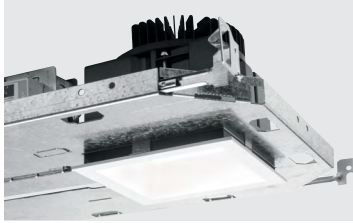

CATALOG #: _____

TYPE: _____

PROJECT: _____

NEW CONSTRUCTION AND REMODEL

ORDERING EXAMPLE: 4DS - L21/9DW - OPTIONS - DIM1 - UNV - LW - OF - WH - TRIM OPTIONS - N - F1



HOUSING

SERIES	LUMENS ^[1]	COLOR	OPTIONS	CONTROL	VOLTAGE
4DS	L7 700lm L13 1,300lm L21 2,100lm	9DW Dim to warm (95 CRI, 1800K – 3000K)	See page 3 for EMERGENCY BATTERY OPTIONS. CP Chicago plenum (CCEA) ^[2] F Fuse kit ATH Airtight construction ^[3] SDT Stepdown transformer ^[4]	DIM1 1% dimming driver (0-10V signal to control dimming and CCT) LUT Lutron Ecosystem enabled ^[5]	UNV 120-277V 347 347V ^[6]

TRIM^[7]

TRIM TYPE	DISTRIBUTION ^[8]	FLANGE TYPE	REFLECTOR FINISH	TRIM OPTIONS
L Flush lens	W Wide	OF 1/2" standard flange	Open trim types CS Clear semi-specular anodize SG Satin-glow anodize GD Gold anodize CG Champagne gold anodize PW Pewter anodize SPC Clear specular anodize RG Rose gold anodize	MWT Textured white trim flange ^[13] IP IP65 rated trim ^[14] AD Diffuse acrylic lens ^[15] PD Diffuse 1/8" polycarbonate lens ^[16] WET/CC Wet location, covered ceiling listed ^[17] AM Anti-microbial ^[18]
O Open reflector	55° Open	SF 1/4" mud-in flange ^[11]	Lens trim types CS Clear semi-specular powder coat WH White texture powder coat BL Black texture powder coat MB Black texture splay with white flange ^[12]	
R Regressed lens	60° Flush			
A Angled lens ^[9]	60° Regressed			
	M Medium			
	45° Open			
	35° Flush			
	35° Regressed			
	N Narrow			
	40° Open			
	25° Flush			
	25° Regressed			
	WW Wall wash ^[10]			

MOUNTING

MOUNTING TYPE ^[19]	MOUNTING HARDWARE ^[20]
N Open pan for new construction	F1 Integral 2-position fixed pan bracket, universal bar hanger included ^[23]
I IC-rated enclosure for new construction ^[21]	BA1 Adjustable butterfly pan bracket, bar hanger not included ^[24]
R Remodel kit ^[22]	CA1 Adjustable caterpillar pan bracket, universal bar hanger included ^[25]

NOTES

- Lumen output based on full light output, L trim type, M distribution and WH finish, 3000K/95CRI. Actual lumens may vary +/-5%. See page 2 for FIXTURE PERFORMANCE DATA.
- I Mounting Type required.
- Not available with EM batteries.
- May be required for 347V, see product builder at hew.com/product-builder
- Not available with I Mounting Type.
- Not available with EM batteries.
- Trim ships separately.
- Beam angle based on CS or WH reflector finish.
- Available with WW Distribution only.
- O and A Trim Types only.
- For use with mud-in plaster construction only, supplied with mud flange installation kit. See page 4 for FLANGE TYPE DETAILS. Not available with ATH or IP options.
- R Trim Type only. Not available with MWT.
- Not available with WH Reflector Finish or L Trim Type.
- L and R trim types only.
- Not available with O trim type. W and WW distributions only.
- Not available with O trim type. W and WW distributions only.
- Not available with O Trim Type. Not available with PD trim option.
- WH and BL Reflector Finishes only.
- Mounting hardware required (N and I only), ordered separately, see MOUNTING HARDWARE ordering info. See page 4 for MOUNTING TYPE DETAILS.
- Additional mounting hardware options available. See page 5 for MOUNTING HARDWARE DETAILS.
- L7 and L13 lumen packages only. Not available with EM batteries.
- Also used in new construction sheetrock ceilings. Pan-less installation.
- N and I Mounting Types only. I Mounting requires external brackets.
- N Mounting Type only.
- N Mounting Type only.

4DS dim to WARM

4.5" Downlight – Square

FEATURES

- Mimic the comfortable, welcoming glow of incandescent with warm-dimming technology
- Beam angles ranging from 25° narrow to 60° wide for tailored performance
- 4 inch aperture is unobtrusive in small scale spaces
- Square shape accentuates architectural styles
- New construction mounting pan, IC-rated, or pan-less remodel kit available
- Open reflector with 7 finishes to complement any interior style
- Die-cast trim choices include flush, regressed or angled lens
- Contemporary design provides glare-free illumination for a soft ceiling appearance
- Spring clip retention system eliminates trim sag
- Fully room-side accessible

SPECIFICATIONS

- HOUSING** – Die-cast aluminum trim housing with forged aluminum heat sink. Galvanized steel splice compartment with driver mounting plate/enclosure. Swing-out mounting arms field adjust for ceiling thickness from 1/2" – 2-1/4".
- OPEN REFLECTOR** – Low-iridescent anodized aluminum with top diffuser.
- LENSED TRIM** – Die-cast aluminum frame with micro-prismatic, acrylic lens.
- ELECTRICAL** – High-performance Class 2 C.O.B. LED array. Modular quick-connect plug for easy field-connection of LED light assembly to driver. Reported L70>55,000 hours. Reported L90>55,000 hours. Estimated L70 = 200,000 hours.
- MOUNTING** – Recessed. 20 ga. galvanized steel mounting pan for new construction or IC-rated enclosure. Remodel kit option includes receiver bracket hardware.
- LISTINGS** –
 - cCSAus conforms to UL STD 1598; Certified to CAN/CSA STD C22.2 No. 250.0 for dry and damp locations. LED light assembly conforms to UL 2108 for remote installation.
 - Suitable for wet location under covered ceiling when specified with WET/CC option.
 - IC-rated for direct contact with insulation when specified with I Mounting Type.
 - City of Chicago Environmental Air approved when specified with CP option.
 - Complies with ASTM-E283 when specified with ATH option.
 - RoHS compliant.
 - Complies with the Buy American Act and other federal regulations. Request certification at hew.com/baa.
- WARRANTY** – 5-year limited warranty, see hew.com/warranty.

FIXTURE PERFORMANCE DATA

OPEN REFLECTOR TRIM TYPE

	DIST.	DELIVERED LUMENS	CCT AT 100% (FULL OUTPUT)	CCT AT 1% (FULL DIM)	WATTAGE	EFFICACY (lm/W)
L7	W	629	3000K	1800K	14.0	45
	M	694			14.0	50
	N	709			14.0	51
L13	W	1102			23.4	47
	M	1216			23.4	52
	N	1243			23.4	53
L21	W	1805			37.7	48
	M	1991			37.7	53
	N	2035			37.7	54

FLUSH LENS TRIM TYPE

	DIST.	DELIVERED LUMENS	CCT AT 100% (FULL OUTPUT)	CCT AT 1% (FULL DIM)	WATTAGE	EFFICACY (lm/W)
L7	W	681	3000K	1800K	14.0	49
	M	751			14.0	54
	N	759			14.0	54
L13	W	1193			23.4	51
	M	1316			23.4	56
	N	1330			23.4	57
L21	W	1956			37.7	52
	M	2147			37.7	57
	N	2180			37.7	58

REGRESSED LENS TRIM TYPE

	DIST.	DELIVERED LUMENS	CCT AT 100% (FULL OUTPUT)	CCT AT 1% (FULL DIM)	WATTAGE	EFFICACY (lm/W)
L7	W	654	3000K	1800K	14.0	47
	M	738			14.0	53
	N	751			14.0	54
L13	W	1147			23.4	49
	M	1293			23.4	55
	N	1316			23.4	56
L21	W	1878			37.7	50
	M	2116			37.7	56
	N	2155			37.7	57

MULTIPLIER TABLES

OPEN REFLECTOR FINISH		
CATALOG NUMBER	REFLECTOR FINISH	CONVERSION FACTOR
CS	Clear semi-specular	1.00
SG	Satin-glow	0.92
GD	Gold	0.93
CG	Champagne Gold	0.96
PW	Pewter	0.86
SPC	Specular	1.02
RG	Rose Gold	0.88
WH	White, textured	0.89
BL	Black, textured	0.79

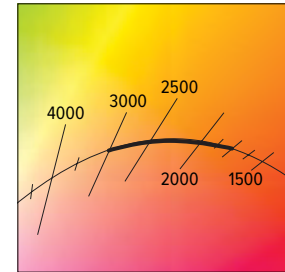

TRIM	
CATALOG NUMBER	CONVERSION FACTOR
AD	0.85
PD	0.85

- Photometrics tested in accordance with IESNA LM-79. Results shown are based on 25°C ambient temperature.
- Wattage shown is based on 120V input.
- Results based on 3000K, 95 CRI, full output, actual lumens may vary +/-5%
- To calculate lumen output in emergency mode, multiply the battery wattage by the efficacy.
- Use multiplier tables to calculate additional options.

PHOTOMETRY

4DS-L21/9DW-DIM1-UNV-LW-OF-WH Total Luminaire Output: 1956 lumens; 37.7 Watts | Efficacy: 51.9 lm/W | 95.0 CRI; 3000K CCT

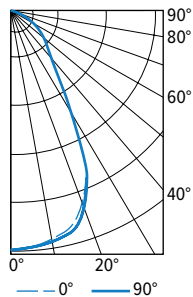

CANDLEPOWER DISTRIBUTION	VERTICAL ANGLE	HORIZONTAL ANGLE			ZONAL LUMENS
		0°	45°	90°	
		0	1454	1454	
5	1441	1441	1442	137	
15	1359	1379	1388	386	
25	1055	1194	1058	502	
35	477	726	468	368	
45	302	328	299	246	
55	183	188	182	169	
65	96	93	94	97	
75	40	39	40	43	
85	5	4	6	8	
90	0	0	0		

LUMEN SUMMARY	ZONE	LUMENS	% FIXTURE
	0 - 30	1025	52
	0 - 40	1393	71
	0 - 60	1807	92
	0 - 90	1956	100
	0 - 180	1956	100



4DS dim to **WARM** 4.5" Downlight – Square

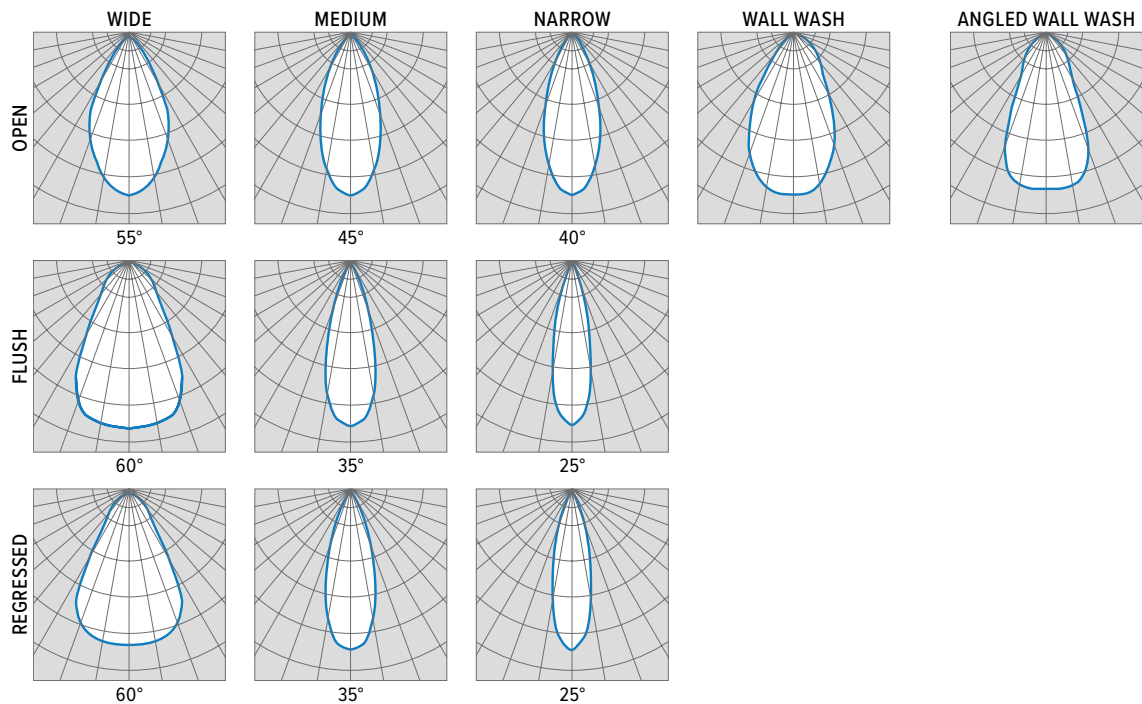

EMERGENCY BATTERY OPTIONS

Additional limitations apply, see page 1. Specify CEC in the option code when California Energy Commission regulations are required.

CATALOG NUMBER	DESCRIPTION
EM/7W	7-watt emergency battery ¹
EM/7W/RTS	7-watt emergency battery with regressed test switch ²
EM/7W/IPRTS	7-watt emergency battery with IP65 rated regressed test switch
EM/10W	10-watt emergency battery ¹
EM/10W/RTS	10-watt emergency battery with regressed test switch ²
EM/10W/IPRTS	10-watt emergency battery with IP65 rated regressed test switch

- ¹ Not available with IP Option.
- ² Not available with IP or WET/CC Options.

REGRESSED TEST SWITCH DETAILS

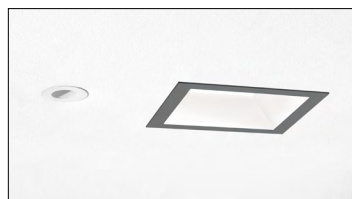

Shown Installed

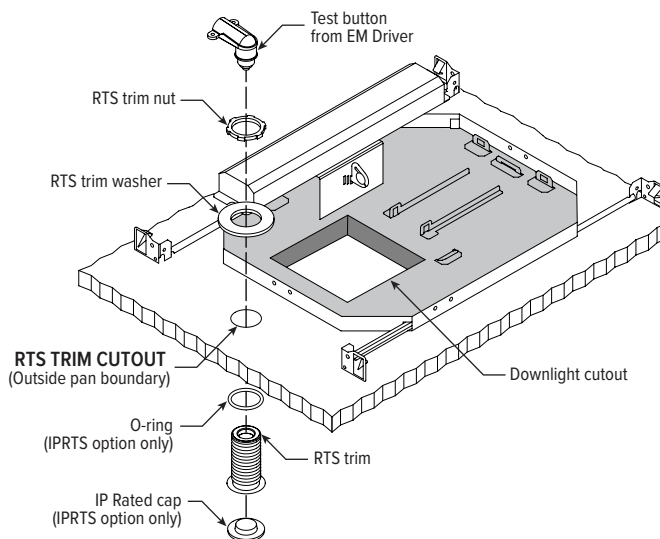

4DS dim to WARM

4.5" Downlight – Square

TRIM TYPE DETAILS

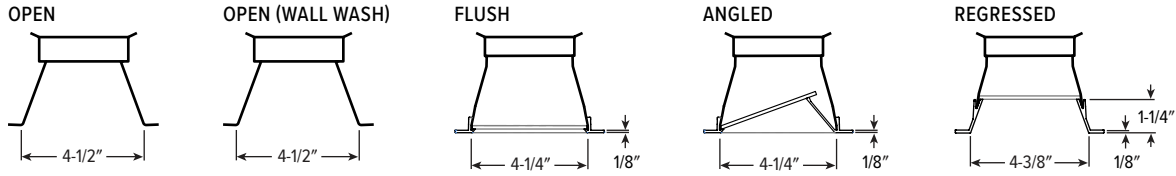

FLANGE TYPE DETAILS

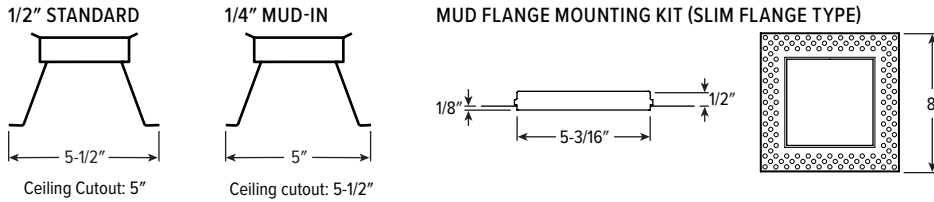

REFLECTOR FINISH DETAILS

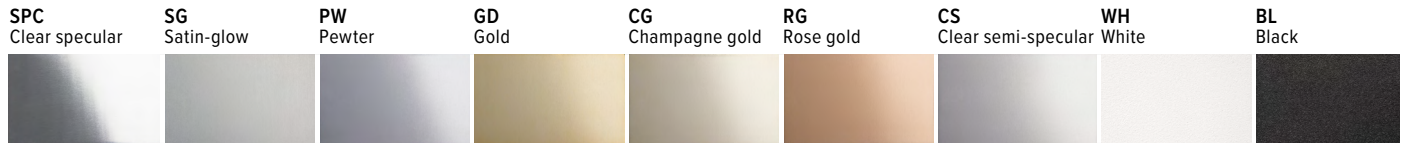

MOUNTING TYPE DETAILS

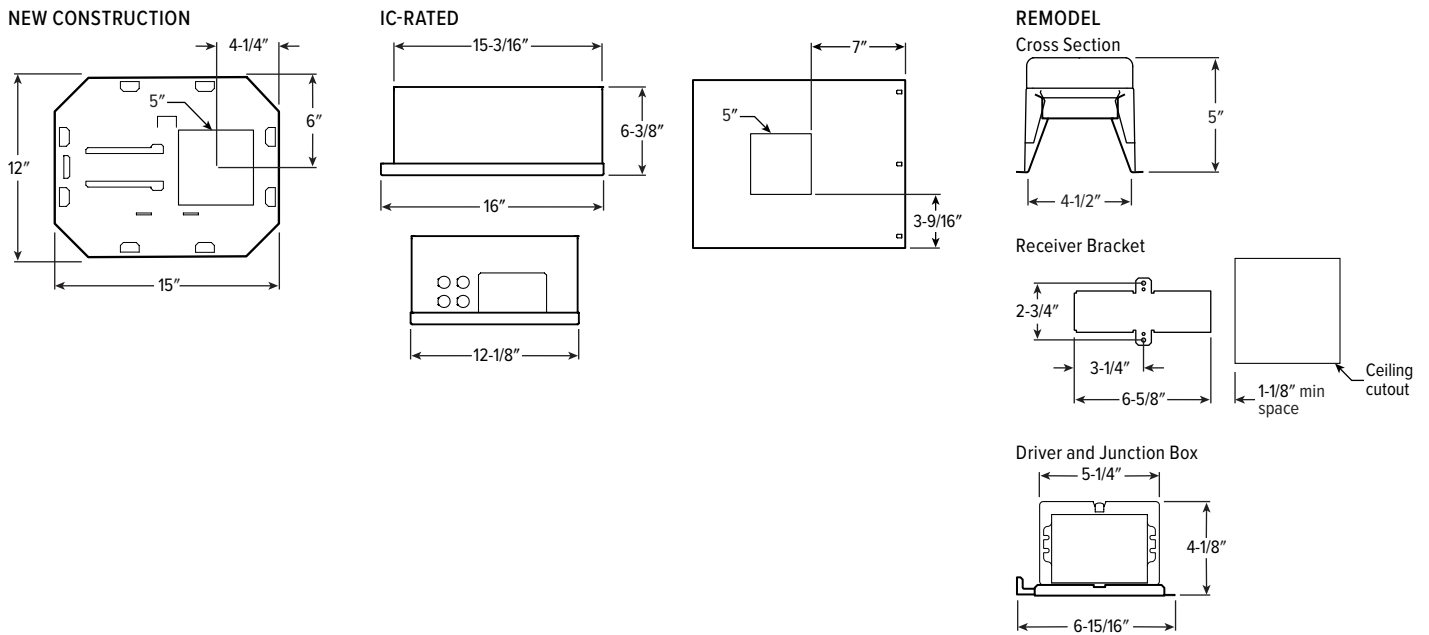

4DS dim to WARM

4.5" Downlight – Square

APERTURE ADAPTOR ORDERING INFO

ORDERING EXAMPLE: 4DR - GR - 0575 - WHT				
SERIES	CATALOG NUMBER	CEILING CUTOUT	FINISH	
4AR	6AR	Specify ceiling cutout in 1/8" increments. Example: 5.75" = 0575	GR	CS Clear semi-specular powder coat
4DR	6DR			WH White texture powder coat
4DS	6DS			BL Black texture powder coat
4PR	6PR			
4PS	6PS			
	8DR			

For use with remodel downlights. Additional finishes available, consult factory.
For limitations and instructions, see hew.com/aperture-adaptor.pdf

MOUNTING HARDWARE DETAILS

F1 Integral 2-position fixed pan bracket, universal bar hanger included

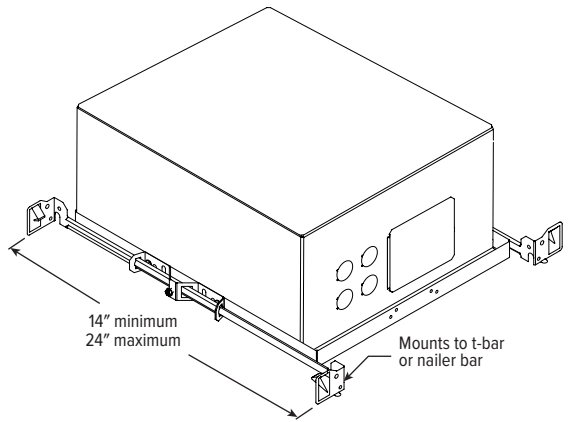
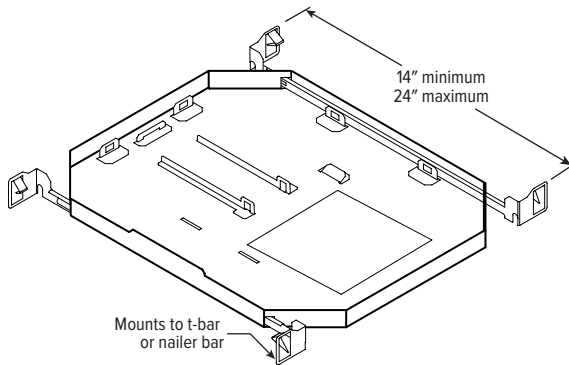

F1 with I Mounting Type

BA1 Adjustable butterfly pan bracket, bar hanger not included (N Mounting Type only)

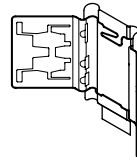

BA2 Adjustable butterfly pan bracket, heavy-duty universal bar hanger included (N Mounting Type only)

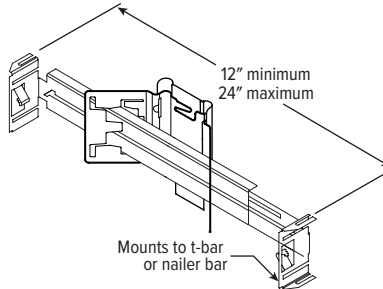

CA1 Adjustable caterpillar pan bracket, universal bar hanger included (N Mounting Type only)

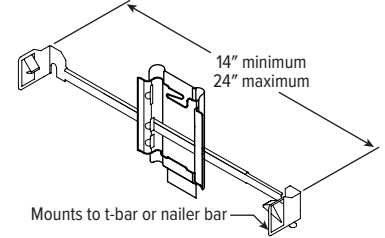

CA2 Adjustable caterpillar pan bracket, t-bar hanger included (N Mounting Type only)

