

4DS LED 4.5" Downlight – Square

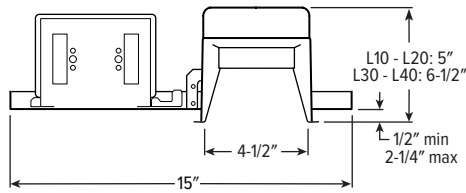
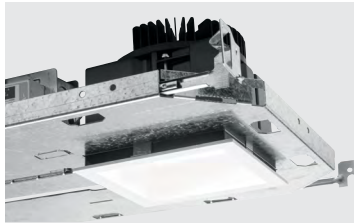

CATALOG #: _____

TYPE: _____

PROJECT: _____

NEW CONSTRUCTION AND REMODEL

ORDERING EXAMPLE: 4DS - L20/835 - HOUSING - OPTIONS - CONTROL/DIM - UNV - LW - OF - WH - TRIM OPTIONS - N - F1 MOUNT.



HOUSING

SERIES	LUMENS ^[1]	CRI	CCT	OPTIONS	CONTROL	DRIVER	VOLTAGE
4DS	L10 1,000lm L15 1,500lm L20 2,000lm L30 3,000lm L40 4,000lm	8 80 9 90 ^[2]	27 2700K 30 3000K 35 3500K 40 4000K 50 5000K	See page 4 for EMERGENCY BATTERY OPTIONS. ATH Airtight construction ^[3] F Fuse kit SDT Stepdown transformer ^[4] CP Chicago plenum (CCEA) ^[5]	See page 6 for ADDITIONAL CONTROL/DRIVER OPTIONS. - None AVI-LVFA Avi-on wireless fixture control ^[6]	See page 6 for ADDITIONAL CONTROL/DRIVER OPTIONS. DIM Dimming driver, 0-10V DIM1 1% Dimming driver, 0-10V DA Driver with 12V auxiliary power, without external dimming wires ^[7]	UNV 120-277V 347 347V ^[8]

TRIM^[9]

TRIM TYPE	DISTRIBUTION ^[10]	FLANGE TYPE	REFLECTOR FINISH	TRIM OPTIONS
L Flush lens	W Wide	OF 1/2" standard flange	Open trim types	MWT Textured white trim flange ^[17]
O Open reflector	55° Open	SF 1/4" mud-in flange ^[15]	CS Clear semi-specular anodize	IP IP65 rated trim ^[18]
R Regressed lens	60° Flush		SG Satin-glow anodize	AD Diffuse acrylic lens ^[19]
A Angled lens ^[11]	60° Regressed		GD Gold anodize	PD Diffuse 1/8" polycarbonate lens ^[20]
	M Medium ^[12]		CG Champagne gold anodize	WET/CC Wet location, covered ceiling listed ^[21]
	45° Open		PW Pewter anodize	AM Anti-microbial ^[22]
	35° Flush		SPC Clear specular anodize	
	35° Regressed		RG Rose gold anodize	
	N Narrow ^[13]		Lens trim types	
	40° Open		CS Clear semi-specular powder coat	
	25° Flush		WH White texture powder coat	
	25° Regressed		BL Black texture powder coat	
	WW Wall wash ^[14]		MB Black texture splay with white flange ^[16]	

MOUNTING

MOUNTING TYPE ^[23]	MOUNTING HARDWARE ^[24]
N Open pan for new construction	F1 Integral 2-position fixed pan bracket, universal bar hanger included ^[27]
I IC-rated enclosure for new construction ^[25]	BA1 Adjustable butterfly pan bracket, bar hanger not included ^[28]
R Remodel kit ^[26]	CA1 Adjustable caterpillar pan bracket, universal bar hanger included ^[29]

NOTES

- Lumen output based on L trim type, W distribution and WH finish, 3500K/80CRI. Actual lumens may vary +/-5%, see page 2 for FIXTURE PERFORMANCE DATA.
- Extended lead times may apply. Consult factory for availability.
- Not available with EM batteries.
- May be required for 347V, see product builder at hew.com/product-builder.
- I Mounting Type required.
- DA Driver only. See page 6 for AVI-ON BLUETOOTH WIRELESS CONTROL DETAILS.
- Avi-on Controls only.
- Not available with EM batteries, DMX Driver, or Avi-on Controls.
- Trim ships separately.
- Beam angle based on CS or WH reflector finish.
- Available with WW Distribution only.
- Not available with L40 lumen package.
- Not available with L40 lumen package.
- O and A Trim Types only.
- For use with mud-in plaster construction only, supplied with mud flange installation kit. See page 3 for FLANGE TYPE DETAILS. Not available with ATH or IP option.
- R Trim Type only. Not available with MWT.
- Not available with WH Reflector Finish or L Trim Type.
- L and R trim types only.
- Not available with O trim type. W and WW distributions only.
- Not available with O trim type. W and WW distributions only.
- Not available with O Trim Type. Not available with PD trim option.
- WH and BL Reflector Finishes only.
- Mounting hardware required (N and I only), ordered separately, see MOUNTING HARDWARE ordering info. See page 4 for MOUNTING TYPE DETAILS.
- Additional mounting hardware options available. See page 5 for MOUNTING HARDWARE DETAILS.
- Not available with L30 or L40 lumen packages. Not available with EM batteries.
- Also used in new construction sheetrock ceilings. Pan-less installation.
- N and I Mounting Types only. I Mounting requires external brackets.
- N Mounting Type only.
- N Mounting Type only.



4DS LED 4.5" Downlight – Square

FEATURES

- Beam angles ranging from 25° narrow to 60° wide for tailored performance
- Die-cast trim choices include flush, regressed or angled lens
- Spring clip retention system eliminates trim sag
- IP65-rated die-cast trim includes easy-to-clean flush lens
- Fully room-side accessible
- Available with Avi-on wireless fixture controls
- Available with BIOS® SkyBlue® technology to support proper daytime circadian stimulus



SPECIFICATIONS

- **HOUSING** – Die-cast aluminum trim housing with forged aluminum heat sink. Galvanized steel splice compartment with driver mounting plate/enclosure. Swing-out mounting arms field adjust for ceiling thickness from 1/2" – 2-1/4".
- **OPEN REFLECTOR** – Low-iridescent anodized aluminum with top diffuser.
- **LENSED TRIM** – Die-cast aluminum frame with micro-prismatic, acrylic lens.
- **ELECTRICAL** – High-performance Class 2 C.O.B. LED array. Modular quick-connect plug for easy field-connection of LED light assembly to driver. Reported L70>55,000 hours. Reported L90>55,000 hours. Estimated L70 = 200,000 hours.
- **MOUNTING** – Recessed. 20 ga. galvanized steel mounting pan for new construction or IC-rated enclosure. Remodel kit option includes receiver bracket hardware. Minimum 24" O.C. marked spacing required for L40 lumen package.
- **LISTINGS** –
 - cCSAus conforms to UL STD 1598; Certified to CAN/CSA STD C22.2 No. 250.0 for dry and damp locations. LED light assembly conforms to UL 2108 for remote installation.
 - Suitable for wet location under covered ceiling when specified with WET/CC option.
 - IC-rated for direct contact with insulation when specified with I Mounting Type.
 - City of Chicago Environmental Air approved when specified with CP option.
 - Complies with ASTM-E283 when specified with ATH option.
 - RoHS compliant.
 - Title 24 (JA8) compliant in select configurations, see www.cacertappliances.energy.ca.gov.
 - Complies with the Buy American Act and other federal regulations. Request certification at hew.com/baa.
- **WARRANTY** – 5-year limited warranty, see hew.com/warranty.

FIXTURE PERFORMANCE DATA

OPEN REFLECTOR TRIM TYPE

	DISTRIBUTION	DELIVERED LUMENS	WATTAGE	EFFICACY (lm/W)
L10	W	947	12.0	79
	M	1045	12.0	87
	N	1067	12.0	89
L15	W	1395	17.4	80
	M	1540	17.4	89
	N	1573	17.4	90
L20	W	1893	25.0	76
	M	2089	25.0	84
	N	2134	25.0	85
L30	W	2839	36.0	79
	M	3090	36.0	86
	N	2999	36.0	83
L40	W	3739	45.0	83
	M	-	-	-
	N	-	-	-

FLUSH LENS TRIM TYPE

	DISTRIBUTION	DELIVERED LUMENS	WATTAGE	EFFICACY (lm/W)
L10	W	1026	12.0	86
	M	1127	12.0	94
	N	1144	12.0	95
L15	W	1511	17.4	87
	M	1666	17.4	96
	N	1684	17.4	97
L20	W	2050	25.0	82
	M	2261	25.0	90
	N	2285	25.0	91
L30	W	3077	36.0	86
	M	3333	36.0	93
	N	3214	36.0	89
L40	W	4053	45.0	90
	M	-	-	-
	N	-	-	-

REGRESSED LENS TRIM TYPE

	DISTRIBUTION	DELIVERED LUMENS	WATTAGE	EFFICACY (lm/W)
L10	W	986	12.0	82
	M	1111	12.0	93
	N	1127	12.0	94
L15	W	1453	17.4	84
	M	1637	17.4	94
	N	1660	17.4	95
L20	W	1972	25.0	79
	M	2221	25.0	89
	N	2253	25.0	90
L30	W	2957	36.0	86
	M	3285	36.0	91
	N	3166	36.0	88
L40	W	3895	45.0	87
	M	-	-	-
	N	-	-	-

MULTIPLIER TABLES

	COLOR TEMPERATURE	
	CCT	CONVERSION FACTOR
80 CRI	2700K	0.92
	3000K	0.98
	3500K	1.00
	4000K	1.01
	5000K	1.02
90 CRI	2700K	0.76
	3000K	0.79
	3500K	0.82
	4000K	0.84
	5000K	0.88

OPEN REFLECTOR FINISH		
CATALOG NUMBER	REFLECTOR FINISH	CONVERSION FACTOR
CS	Clear semi-specular	1.00
SG	Satin-glow	0.83
GD	Gold	0.93
CG	Champagne Gold	0.96
PW	Pewter	0.86
SPC	Specular	1.02
RG	Rose Gold	0.88
WH	White, textured	0.99
BL	Black, textured	0.79

TRIM	
CATALOG NUMBER	CONVERSION FACTOR
AD	0.85
PD	0.85

- Photometrics tested in accordance with IESNA LM-79. Results shown are based on 25°C ambient temperature.
- Wattage shown is based on 120V input.
- Results based on 3500K, 80 CRI, actual lumens may vary +/-5%
- To calculate lumen output in emergency mode, multiply the battery wattage by the efficacy.
- Use multiplier table to calculate additional options.



4DS LED 4.5" Downlight – Square

PHOTOMETRY

4DS-L20/835-DIM-UNV-LW-OF-WH Report #: 20316; 04/16/18 | Total Luminaire Output: 2050 lumens; 25.0 Watts | Efficacy: 82 lm/W | 83.8 CRI; 3478K CCT

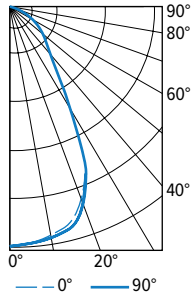

CANDLEPOWER DISTRIBUTION	VERTICAL ANGLE	HORIZONTAL ANGLE			ZONAL LUMENS
		0°	45°	90°	
	0	1526	1526	1526	
	5	1512	1512	1513	144
	15	1426	1447	1456	410
	25	1107	1253	1110	546
	35	501	762	491	372
	45	317	344	314	254
	55	192	197	191	175
	65	101	98	99	100
	75	42	41	42	44
	85	5	4	6	5
	90	0	0	0	

LUMEN SUMMARY	ZONE	LUMENS	% FIXTURE
	0 - 30	1100	54
	0 - 40	1472	72
	0 - 60	1902	93
	0 - 90	2050	100
	0 - 180	2050	100

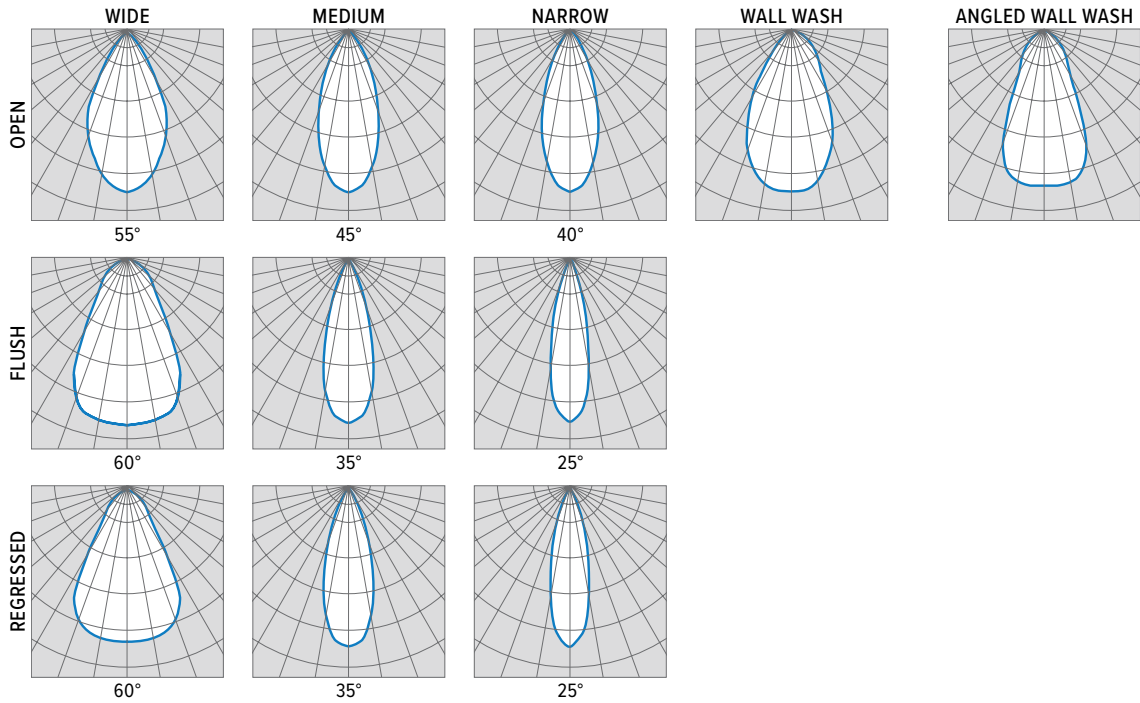

TRIM TYPE DETAILS

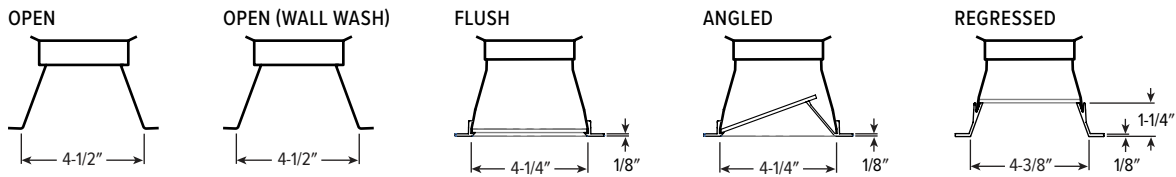

FLANGE TYPE DETAILS

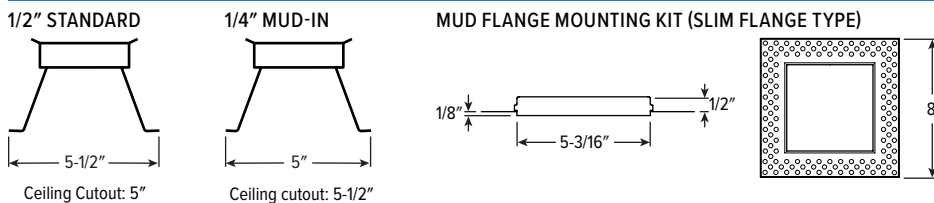

4DS LED 4.5" Downlight – Square

REFLECTOR FINISH DETAILS

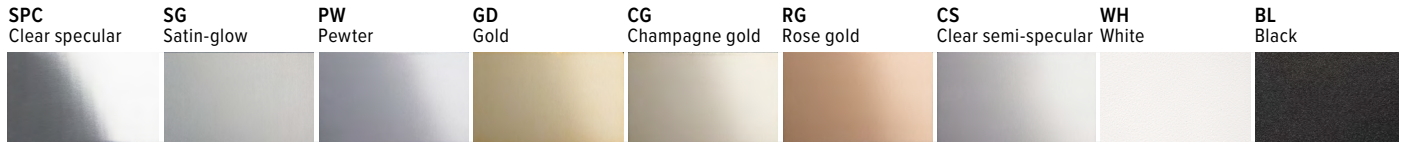

MOUNTING TYPE DETAILS

NEW CONSTRUCTION

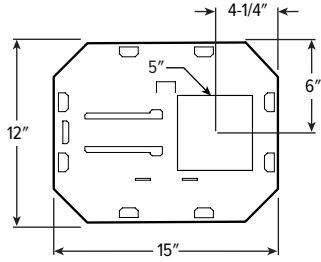

IC-RATED

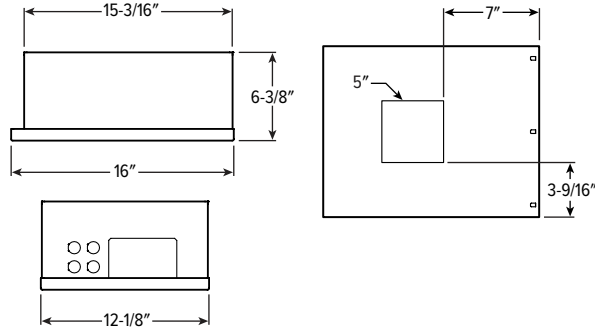

REMODEL

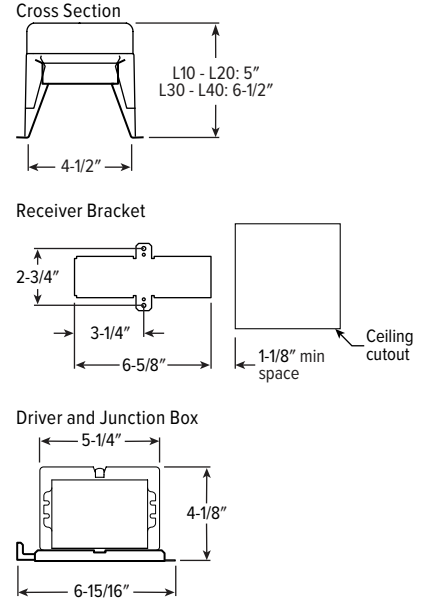

EMERGENCY BATTERY OPTIONS

Additional limitations apply, see page 1. Specify CEC in the option code when California Energy Commission regulations are required.

CATALOG NUMBER	DESCRIPTION
EM/7W	7-watt emergency battery ¹
EM/7W/RTS	7-watt emergency battery with regressed test switch ²
EM/7W/IPRTS	7-watt emergency battery with IP65 rated regressed test switch
EM/10W	10-watt emergency battery ¹
EM/10W/RTS	10-watt emergency battery with regressed test switch ²
EM/10W/IPRTS	10-watt emergency battery with IP65 rated regressed test switch

- ¹ Not available with IP Option.
- ² Not available with IP or WET/CC Options.

REGRESSED TEST SWITCH DETAILS

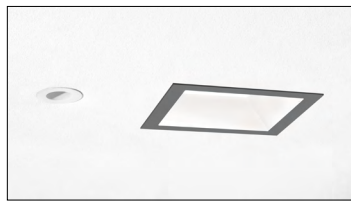

Shown Installed

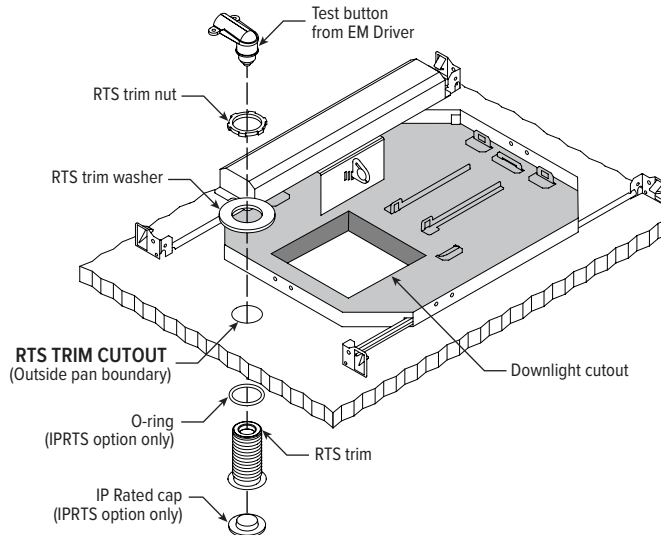

4DS^{LED} 4.5" Downlight – Square

APERTURE ADAPTOR ORDERING INFO

ORDERING EXAMPLE: 4DR - GR - 0575 - WHT			
SERIES	CATALOG NUMBER	CEILING CUTOUT	FINISH
4AR	6AR	Specify ceiling cutout in 1/8" increments. Example: 5.75" = 0575 See Kit Components for application limits.	CS Clear semi-specular powder coat
4DR	6DR		WH White texture powder coat
4DS	6DS		BL Black texture powder coat
4PR	6PR		
4PS	6PS		
	8DR		

For use with remodel downlights. Additional finishes available, consult factory.
For limitations and instructions, see hew.com/aperture-adaptor.pdf

MOUNTING HARDWARE DETAILS

F1 Integral 2-position fixed pan bracket, universal bar hanger included

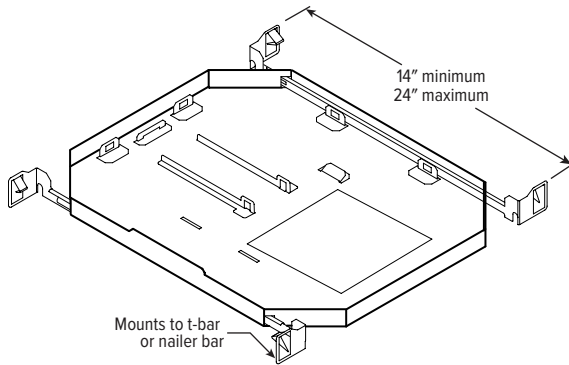

BA1 Adjustable butterfly pan bracket, bar hanger not included (N Mounting Type only)

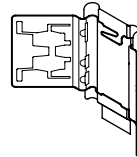

CA1 Adjustable caterpillar pan bracket, universal bar hanger included (N Mounting Type only)

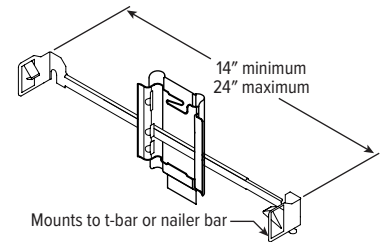

BA2 Adjustable butterfly pan bracket, heavy-duty universal bar hanger included (N Mounting Type only)

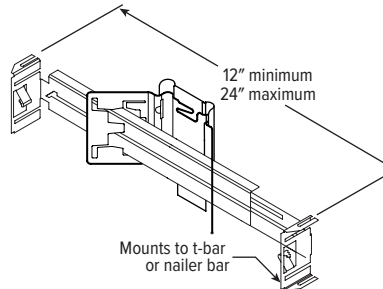

CA2 Adjustable caterpillar pan bracket, t-bar hanger included (N Mounting Type only)

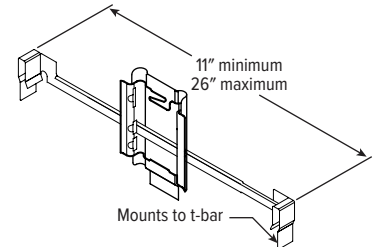

F1 with I Mounting Type

SEE NEXT PAGE FOR CONTROL DETAILS.



4DS^{LED} 4.5" Downlight – Square

AVI-ON BLUETOOTH WIRELESS CONTROL DETAILS

FEATURES

Simple

- Gateway-free distributed control
- Factory pre-commissioning
- Contractor friendly installation
- Occupancy/vacancy/daylight sensing

Scalable

- Virtually unlimited network size
- Spans small offices to large warehouses
- Flexible control strategies

Secure

- Optional cloud connectivity
- UL IoT platinum security rating
- DLC 5.0 compliant

DIGITAL INSTALLATION TOOLS

Avi-On mobile apps provide intuitive, quick installation and commissioning. Pro tools are available to qualified installers.



Commissioning Mobile App

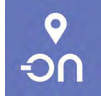

Zone Scanner Web App



Commissioning Pro App

SYSTEM COMPONENTS

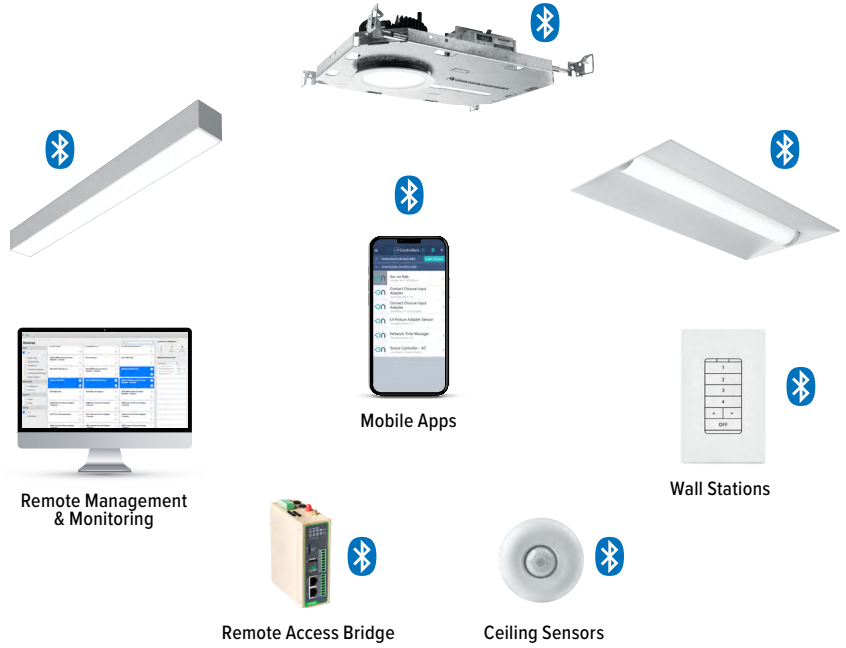

The Bluetooth® word mark and logos are registered trademarks owned by Bluetooth SIG, Inc. and any use of such marks by Avi-on is under license. Other trademarks and trade names are those of their respective owners.

ACCESSORIES

WALL STATIONS	
AVI-2401AC	Scene controller - numbered 1-4, 120-277VAC
AVI-2402BAT	Scene controller - numbered 1-4, battery powered
AVI-2401AC-2	Dimmer with presets - percentages, 120-277VAC
AVI-2402BAT-2	Dimmer with presets - percentages, battery powered
AVI-2401AC-3	On/off/dimming, 120-277VAC
AVI-2402BAT-3	On/off/dimming, battery powered

NETWORK	
AVI-RAB-LTE	Remote access bridge – LTE connection
AVI-2001RAB-01-C	Remote access bridge – Wifi connection
AVI-KIT-NTM	Network time manager with battery backup

CEILING MOUNT SENSORS	
AVI-KIT-SEN-DUCM	PIR motion and ultrasonic sensor kit
AVI-KIT-SEN-ICM	PIR motion and photocell sensor kit

For load controllers and additional accessory info, see hew.com/avi-on

ADDITIONAL CONTROL/DRIVER OPTIONS

Lumen restrictions apply: L30 max for DMX driver, L30 max for Lutron drivers, L40 max for DIM LINE driver. R Mounting Type not available with DMX or FCJS controls. R Mounting Type requires 12" minimum plenum depth when specified with VRF/DBI controls. 347V may require stepdown transformer, see product builder at hew.com/product-builder. I Mounting Type not available with Lutron controls.

CATALOG NUMBER	DESCRIPTION
AVI-LVFA/DA	Avi-on wireless fixture control for use with driver with 12V auxiliary power
VRF/DBI/LDE1	Lutron Vive integral fixture control, RF only (DFCSJ-OEM-RF) and digital link interface, with Lutron Hi-lume 1% EcoSystem dimming LED driver
FCJS/DIM	Lutron Vive PowPak wireless fixture control with dimming driver
FCJS/DIM1	Lutron Vive PowPak wireless fixture control with 1% dimming driver
DIM	Dimming driver prewired for 0-10V low voltage applications
DIM1	1% dimming driver prewired for 0-10V low voltage applications
DIM LINE	Line voltage dimming driver (TRIAC and ELV compatible at 120V only)
DALI	DALI dimming driver
DMX	0.1% dimming driver for DMX controls
LDE1	Lutron Hi-lume 1% EcoSystem dimming LED driver

