

Pursuit™ – Direct (Down)

TYPE

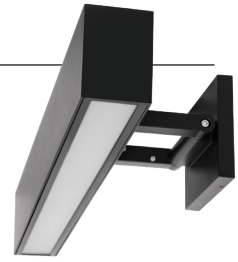

FEATURES

- 2', 3', 4', 6' & 8' housing lengths
- Sections can be joined for runs up to 150' with seamless lens
- IP66 Rated
- Light engine is independently rated IP67
- Electrical connections IP68 rated
- Symmetric, asymmetric, wall graze & wall wash distributions
- "L", "T" & "X" illuminated connectors for custom shapes
- NX Distributed Intelligence & SiteSync enabled for wireless control
- Output up to 1,500 lm/ft
- Surface, fixed arm, adjustable arm, pendant, mullion & wall mounting options

NX DISTRIBUTED INTELLIGENCE

SiteSync
LIGHTING CONTROL



IK08



ORDERING CODE

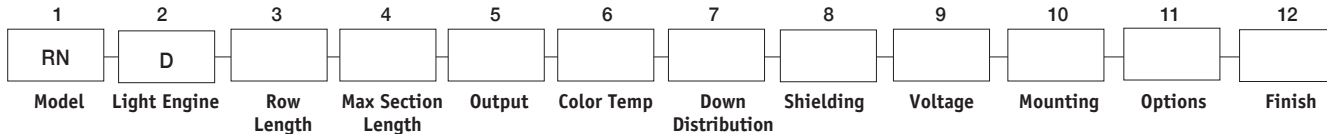

1. MODEL

RN Pursuit

2. LIGHT ENGINE

D Direct (Down)

3. ROW LENGTH

Manual input (150' Max length. round up to nearest whole foot)

4. MAXIMUM FIXTURE SECTION LENGTH

2	2' Fixture
3	3' Fixture
4	4' Fixture
6	6' Fixture
8	8' Fixture

5. OUTPUT

5	500 lumens/ft
7	750 lumens/ft
10	1000 lumens/ft
15	1500 lumens/ft

6. COLOR TEMPERATURE

3K8	3000K, 80 CRI
3K9	3000K, 90 CRI
4K8	4000K, 80 CRI
4K9	4000K, 90 CRI
5K8	5000K, 80 CRI

Consult factory for additional CCT options.

7. DISTRIBUTIONS

SM	Symmetrical
AS	Asymmetrical
WG	Wall graze
WW	Wall wash

8. SHIELDING

DL	Diffuse lens
CL	Clear lens

9. VOLTAGE

UNV	120-277V
347	347V
480	480V

10. MOUNTING

W	Wall
A3	3" Adjustable arm
A6	6" Adjustable arm
A12	12" Adjustable arm
F3	3" Fixed arm
F6	6" Fixed arm
F12	12" Fixed arm
M	Mullion
S	Surface
PSW12	12" Pendant
PSW24	24" Pendant
PSW36	36" Pendant

11. OPTIONS

EMF1	End Power Feed at one end
EMF2	End Power Feed at both ends

Photocell Options

PC	Button photocell ⁽¹⁾
----	---------------------------------

Control Options - Not available with PC ⁽¹⁾

SCP	Dimming Occupancy Sensor
SWP	SiteSync Wireless
SWPM	SiteSync Wireless with SCP
NXWE	NX Wireless Enabled
NXOSW	NX Wireless, PIR Occupancy Sensor, Dimming Daylight Harvesting

Emergency Battery Option

EM	Battery Backup Unit (-20°C) ⁽²⁾
----	--

12. FIXTURE FINISH

Standard Color

BL	Black
BLT	Matte Black
DB	Dark Bronze
GT	Graphite
MG	Medium Grey
TT	Titanium
WH	White
CUSTOM	Custom Color

Note:

⁽¹⁾ Requires auxiliary housing. Fixture length will increase.

⁽²⁾ Integral battery backup for 3, 4, 6 and 8 foot versions only. Not available on 2' housing.

ACCESSORIES

Non Illuminated Connectors - Enable Custom Shapes (see separate spec sheet)

ORDERING PREFIX

RNLTX-L-D	L shape
RNLTX-T-D	T shape
RNLTX-X-D	X shape

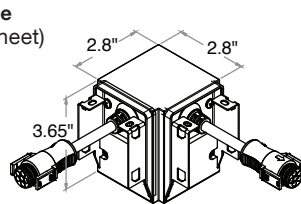

L Shape

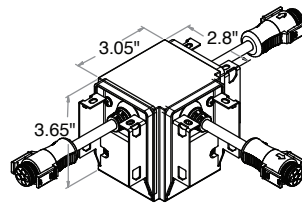

T Shape

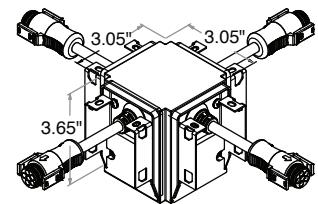

X Shape



ARCHITECTURAL AREA LIGHTING
17760 Rowland Street | City of Industry | CA 91748
P 626.968.5666 | F 626.369.2695 | www.aal.net
Copyright © 2018 October 18, 2019 10:04 AM

JOB	_____
TYPE	_____
NOTES	_____

Pursuit™ – Direct (Down)

| TYPE

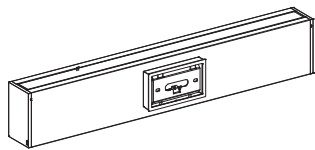
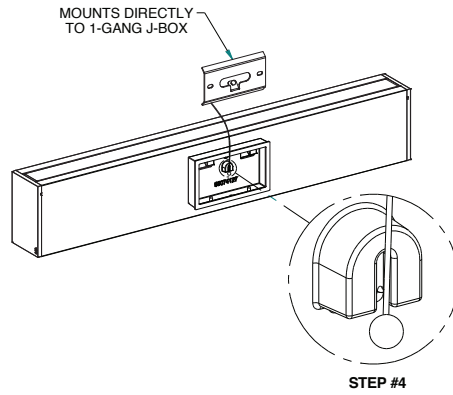
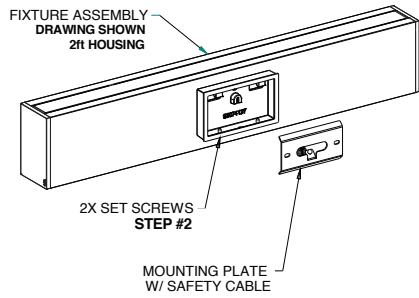

WALL MOUNT



SIDE VIEW WALL MOUNT

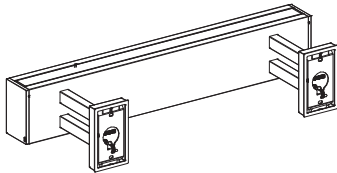

FIXED ARM MOUNT

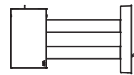

SIDE VIEW FIXED ARM MOUNT

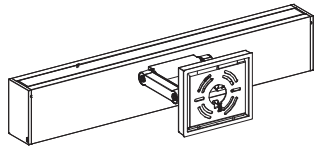

ADJUSTABLE ARM MOUNT

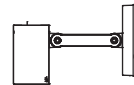

SIDE VIEW ADJUSTABLE ARM MOUNT

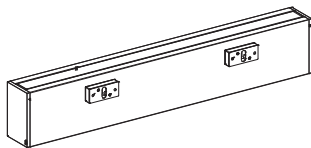

MULLION MOUNT



SIDE VIEW MULLION MOUNT

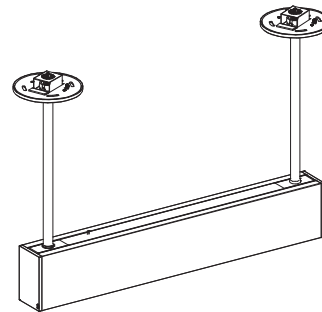

PENDANT ARM MOUNT

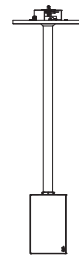

SIDE VIEW PENDANT ARM MOUNT

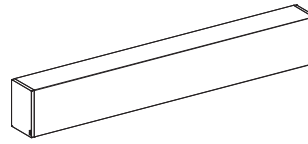

SURFACE MOUNT



SIDE VIEW SURFACE MOUNT

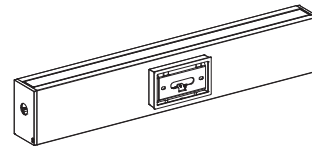

WALL MOUNT SHOWN WITH EMF OPTION



SIDE VIEW WITH EMF OPTION



ARCHITECTURAL AREA LIGHTING
 17760 Rowland Street | City of Industry | CA 91748
 P 626.968.5666 | F 626.369.2695 | www.aal.net
 Copyright © 2018 October 18, 2019 10:04 AM

JOB _____
 TYPE _____
 NOTES _____

Pursuit™ – Direct (Down)

TYPE

DIMENSIONS

FIXTURE

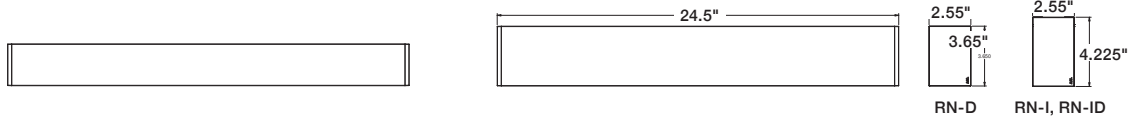

FIXED ARM

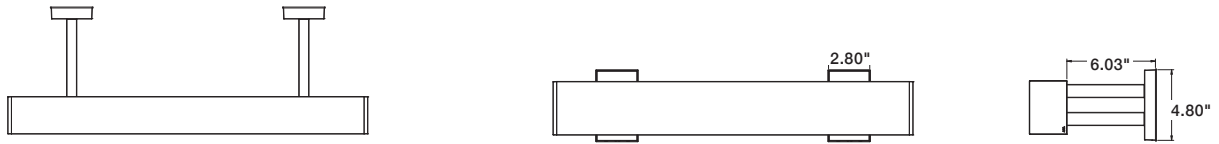

WALL

2ft fixture has 1 mounting point

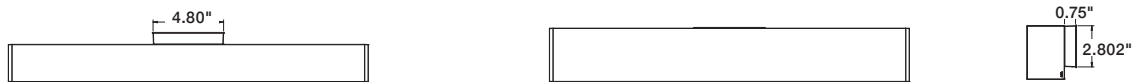

WALL

3, 4, 6 & 8ft fixtures have 2 mounting points

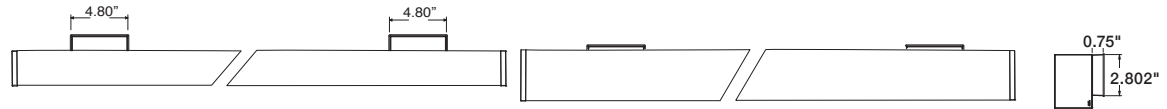

ADJUSTABLE ARM

2ft fixture has 1 mounting point

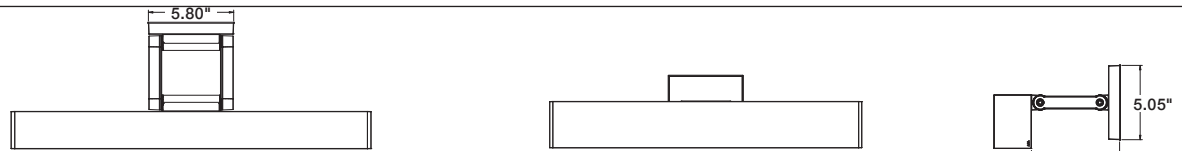

ADJUSTABLE ARM

3, 4, 6 & 8ft fixtures have 2 mounting points

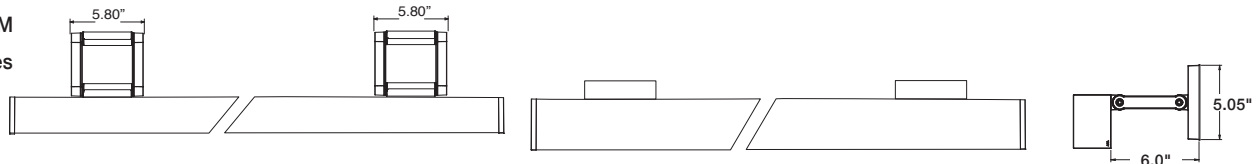

MULLION



PENDANT

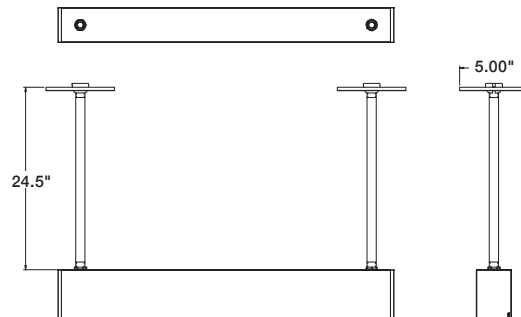

ARCHITECTURAL AREA LIGHTING
 17760 Rowland Street | City of Industry | CA 91748
 P 626.968.5666 | F 626.369.2695 | www.aal.net
 Copyright © 2018 October 18, 2019 10:04 AM

JOB _____
 TYPE _____
 NOTES _____

Pursuit™ – Direct (Down)

TYPE

LUMINAIRE PERFORMANCE–DIRECT (DOWN)

Section Length	Lumens/ft	Nominal Lumen Package	System Watts	Distributions Type	Shielding	5K8		4K9		4K8		3K9		3K8	
						(5000K nominal, 80CRI)		(4000K nominal, 90CRI)		(4000K nominal, 80CRI)		(3000K nominal, 90CRI)		(3000K nominal, 80CRI)	
						Lumens	LPW ¹	Lumens	LPW ¹	Lumens	LPW ¹	Lumens	LPW ¹	Lumens	LPW ¹
2FT	500	1,000	13	SM	Diffuse	1225	94	957	73	1181	90	922	70	1138	87
					Clear	1372	105	1071	82	1323	101	1033	79	1275	97
				AS	Diffuse	1093	83	854	65	1054	81	823	63	1016	78
					Clear	1234	94	973	74	1201	92	943	72	1164	89
				WG	Diffuse	1289	98	1007	77	1243	95	970	74	1198	92
					Clear	1430	109	1117	85	1379	105	1076	82	1329	102
	WW	Diffuse	1093	83	854	65	1054	81	823	63	1016	78			
		Clear	1234	94	973	74	1201	92	943	72	1164	89			
	750	1,500	19	SM	Diffuse	1771	92	1383	72	1708	88	1333	69	1646	85
					Clear	1970	102	1538	80	1899	98	1483	77	1831	95
				AS	Diffuse	1580	82	1234	64	1524	79	1190	62	1469	76
					Clear	1784	92	1393	72	1720	89	1343	69	1658	86
				WG	Diffuse	1864	96	1455	75	1797	93	1403	73	1732	90
					Clear	2067	107	1615	84	1993	103	1556	81	1921	99
	WW	Diffuse	1580	82	1234	64	1524	79	1190	62	1469	76			
		Clear	1784	92	1393	72	1720	89	1343	69	1658	86			
	1,000	2,000	26	SM	Diffuse	2265	89	1769	69	2184	86	1705	67	2105	83
					Clear	2523	99	1970	77	2432	95	1899	74	2345	92
				AS	Diffuse	2021	79	1578	62	1949	76	1521	60	1878	74
					Clear	2282	89	1782	70	2200	86	1718	67	2121	83
				WG	Diffuse	2384	93	1861	73	2298	90	1794	70	2215	87
					Clear	2644	104	2065	81	2550	100	1991	78	2457	96
	WW	Diffuse	2021	79	1578	62	1949	76	1521	60	1878	74			
		Clear	2282	89	1782	70	2200	86	1718	67	2121	83			
1500	3000	41	SM	Diffuse	3048	74	2380	58	2939	72	2294	56	2832	69	
				Clear	3414	83	2666	65	3291	80	2570	63	3172	77	
			AS	Diffuse	2720	66	2124	52	2622	64	2047	50	2527	62	
				Clear	3070	75	2398	58	2960	72	2311	56	2853	70	
			WG	Diffuse	3207	78	2505	61	3092	75	2414	59	2980	73	
				Clear	3558	87	2779	68	3430	84	2678	65	3306	81	
WW	Diffuse	2720	66	2124	52	2622	64	2047	50	2527	62				
	Clear	3070	75	2398	58	2960	72	2311	56	2853	70				



ARCHITECTURAL AREA LIGHTING
 17760 Rowland Street | City of Industry | CA 91748
 P 626.968.5666 | F 626.369.2695 | www.aal.net
 Copyright © 2018 October 18, 2019 10:04 AM

JOB
TYPE
NOTES

Pursuit™ – Direct (Down)

TYPE

LUMINAIRE PERFORMANCE-DIRECT (DOWN) CONT'D

Section Length	Lumens/ft	Nominal Lumen Package	System Watts	Distributions Type	Shielding	5K8 (5000K nominal, 80CRI)		4K9 (4000K nominal, 90CRI)		4K8 (4000K nominal, 80CRI)		3K9 (3000K nominal, 90CRI)		3K8 (3000K nominal, 80CRI)			
						Lumens	LPW ¹	Lumens	LPW ¹	Lumens	LPW ¹	Lumens	LPW ¹	Lumens	LPW ¹	Lumens	LPW ¹
						3FT	500	1,500	19	SM	Diffuse	1838	97	1435	76	1772	94
Clear	2058	109	1607	85	1984						105	1549	82	1912	101		
AS	Diffuse	1640	87	1280	68					1581	84	1234	65	1524	81		
	Clear	1851	98	1445	76					1785	94	1393	74	1720	91		
WG	Diffuse	1934	102	1510	80					1864	99	1455	77	1797	95		
	Clear	2145	113	1675	89					2068	109	1615	85	1993	105		
WW	Diffuse	1640	87	1280	68		1581	84	1234	65	1524	81					
	Clear	1851	98	1445	76		1785	94	1393	74	1720	91					
750	2,250	28	SM	Diffuse	2657		94	2075	73	2561	90	2000	70	2469	87		
				Clear	2955		104	2308	81	2849	100	2224	78	2746	97		
			AS	Diffuse	2370		83	1851	65	2285	80	1784	63	2203	78		
				Clear	2676		94	2090	74	2580	91	2014	71	2487	88		
			WG	Diffuse	2795		98	2183	77	2695	95	2104	74	2598	91		
				Clear	3101		109	2422	85	2990	105	2334	82	2882	101		
WW	Diffuse	2370	83	1851	65		2285	80	1784	63	2203	78					
	Clear	2676	94	2090	74		2580	91	2014	71	2487	88					
1,000	3,000	38	SM	Diffuse	3398		89	2654	69	3276	86	2558	67	3158	83		
				Clear	3785		99	2955	77	3649	96	2849	75	3517	92		
			AS	Diffuse	3032		79	2368	62	2923	77	2282	60	2817	74		
				Clear	3423		90	2673	70	3300	86	2577	67	3181	83		
			WG	Diffuse	3576		94	2792	73	3447	90	2691	70	3323	87		
				Clear	3967		104	3098	81	3824	100	2986	78	3686	96		
WW	Diffuse	3032	79	2368	62		2923	77	2282	60	2817	74					
	Clear	3423	90	2673	70		3300	86	2577	67	3181	83					
1,500	4,500	58	SM	Diffuse	4572	79	3570	62	4408	76	3441	59	4249	73			
				Clear	5121	88	3999	69	4937	85	3854	66	4759	82			
			AS	Diffuse	4079	70	3186	55	3933	68	3071	53	3791	65			
				Clear	4606	79	3597	62	4440	77	3467	60	4280	74			
			WG	Diffuse	4811	83	3757	65	4638	80	3621	62	4471	77			
				Clear	5337	92	4168	72	5146	89	4017	69	4960	86			
WW	Diffuse	4079	70	3186	55	3933	68	3071	53	3791	65						
	Clear	4606	79	3597	62	4440	77	3467	60	4280	74						



ARCHITECTURAL AREA LIGHTING
 17760 Rowland Street | City of Industry | CA 91748
 P 626.968.5666 | F 626.369.2695 | www.aal.net
 Copyright © 2018 October 18, 2019 10:04 AM

JOB _____
 TYPE _____
 NOTES _____

LUMINAIRE PERFORMANCE–DIRECT (DOWN) CONT'D

Section Length	Lumens/ft	Nominal Lumen Package	System Watts	Distributions Type	Shielding	5K8		4K9		4K8		3K9		3K8	
						(5000K nominal, 80CRI)		(4000K nominal, 90CRI)		(4000K nominal, 80CRI)		(3000K nominal, 90CRI)		(3000K nominal, 80CRI)	
						Lumens	LPW	Lumens	LPW	Lumens	LPW	Lumens	LPW	Lumens	LPW
4FT	500	2000	25	SM	Diffuse	2450	98	1913	77	2362	95	1844	74	2277	91
					Clear	2744	110	2143	86	2645	106	2065	83	2550	102
				AS	Diffuse	2186	88	1707	69	2108	85	1645	66	2031	82
					Clear	2468	99	1927	77	2379	96	1858	75	2293	92
				WG	Diffuse	2578	104	2013	81	2485	100	1941	78	2396	96
					Clear	2860	115	2233	90	2757	111	2153	86	2658	107
	WW	Diffuse	2186	88	1707	69	2108	85	1645	66	2031	82			
		Clear	2468	99	1927	77	2379	96	1858	75	2293	92			
	750	3,000	38	SM	Diffuse	3542	94	2766	73	3415	91	2666	71	3292	87
					Clear	3940	105	3077	82	3799	101	2966	79	3661	97
				AS	Diffuse	3161	84	2468	65	3047	81	2379	63	2937	78
					Clear	3568	95	2787	74	3440	91	2686	71	3316	88
				WG	Diffuse	3727	99	2911	77	3593	95	2806	74	3464	92
					Clear	4135	110	3229	86	3987	106	3113	83	3843	102
	WW	Diffuse	3161	84	2468	65	3047	81	2379	63	2937	78			
		Clear	3568	95	2787	74	3440	91	2686	71	3316	88			
	1,000	4,000	52	SM	Diffuse	4531	88	3538	69	4368	85	3410	66	4210	82
					Clear	5046	98	3941	76	4865	94	3798	74	4689	91
				AS	Diffuse	4042	78	3157	61	3897	76	3043	59	3757	73
					Clear	4564	88	3564	69	4400	85	3435	67	4241	82
				WG	Diffuse	4767	92	3723	72	4596	89	3589	70	4430	86
					Clear	5289	102	4130	80	5099	99	3981	77	4915	95
	WW	Diffuse	4042	78	3157	61	3897	76	3043	59	3757	73			
		Clear	4564	88	3564	69	4400	85	3435	67	4241	82			
1,500	6,000	82	SM	Diffuse	6096	74	4760	58	5877	72	4589	56	5665	69	
				Clear	6828	83	5332	65	6582	80	5139	63	6345	77	
			AS	Diffuse	5439	66	4248	52	5244	64	4094	50	5055	62	
				Clear	6141	75	4795	58	5920	72	4622	56	5707	70	
			WG	Diffuse	6414	78	5009	61	6184	75	4828	59	5961	73	
				Clear	7116	87	5557	68	6861	84	5357	65	6613	81	
WW	Diffuse	5439	66	4248	52	5244	64	4094	50	5055	62				
	Clear	6141	75	4795	58	5920	72	4622	56	5707	70				



JOB
TYPE
NOTES

LUMINAIRE PERFORMANCE-DIRECT (DOWN) CONT'D

Section Length	Lumens/ft	Nominal Lumen Package	System Watts	Distributions Type	Shielding	5K8		4K9		4K8		3K9		3K8	
						(5000K nominal, 80CRI)		(4000K nominal, 90CRI)		(4000K nominal, 80CRI)		(3000K nominal, 90CRI)		(3000K nominal, 80CRI)	
						Lumens	LPW	Lumens	LPW	Lumens	LPW	Lumens	LPW	Lumens	LPW
6FT	500	3,000	37	SM	Diffuse	3675	100	2870	78	3543	96	2766	75	3415	93
					Clear	4116	112	3214	87	3968	108	3098	84	3825	104
				AS	Diffuse	3279	89	2561	69	3161	86	2468	67	3047	83
					Clear	3702	100	2891	78	3569	97	2787	76	3440	93
				WG	Diffuse	3867	105	3020	82	3728	101	2911	79	3594	97
					Clear	4290	116	3350	91	4136	112	3229	88	3987	108
	WW	Diffuse	3279	89	2561	69	3161	86	2468	67	3047	83			
		Clear	3702	100	2891	78	3569	97	2787	76	3440	93			
	750	4,500	56	SM	Diffuse	5313	95	4149	74	5123	91	3999	71	4938	88
					Clear	5910	105	4615	82	5698	101	4449	79	5492	98
				AS	Diffuse	4741	84	3702	66	4571	81	3569	63	4406	78
					Clear	5352	95	4180	74	5160	92	4029	72	4974	89
				WG	Diffuse	5591	99	4366	78	5390	96	4208	75	5196	92
					Clear	6202	110	4844	86	5980	106	4669	83	5764	103
	WW	Diffuse	4741	84	3702	66	4571	81	3569	63	4406	78			
		Clear	5352	95	4180	74	5160	92	4029	72	4974	89			
	1,000	6,000	76	SM	Diffuse	6796	89	5307	70	6552	86	5116	67	6316	83
					Clear	7569	99	5911	77	7297	96	5697	75	7034	92
				AS	Diffuse	6064	79	4735	62	5846	77	4564	60	5635	74
					Clear	6846	90	5346	70	6600	87	5153	68	6362	83
				WG	Diffuse	7151	94	5584	73	6894	90	5383	71	6645	87
					Clear	7933	104	6195	81	7649	100	5972	78	7372	97
	WW	Diffuse	6064	79	4735	62	5846	77	4564	60	5635	74			
		Clear	6846	90	5346	70	6600	87	5153	68	6362	83			
1,500	9,000	124	SM	Diffuse	9144	74	7141	58	8816	71	6883	56	8497	69	
				Clear	10241	83	7998	64	9874	80	7709	62	9517	77	
			AS	Diffuse	8159	66	6371	51	7866	63	6141	50	7582	61	
				Clear	9211	74	7193	58	8880	72	6934	56	8560	69	
			WG	Diffuse	9622	78	7514	61	9276	75	7243	58	8941	72	
				Clear	10674	86	8336	67	10291	83	8035	65	9919	80	
WW	Diffuse	8159	66	6371	51	7866	63	6141	50	7582	61				
	Clear	9211	74	7193	58	8880	72	6934	56	8560	69				



JOB _____
 TYPE _____
 NOTES _____

LUMINAIRE PERFORMANCE-DOWN CONT'D

Section Length	Lumens/ft	Nominal Lumen Package	System Watts	Distributions Type	Shielding	5K8		4K9		4K8		3K9		3K8				
						(5000K nominal, 80CRI)		(4000K nominal, 90CRI)		(4000K nominal, 80CRI)		(3000K nominal, 90CRI)		(3000K nominal, 80CRI)				
						Lumens	LPW	Lumens	LPW	Lumens	LPW	Lumens	LPW	Lumens	LPW			
8FT	500	4,000	50	SM	Diffuse	4900	98	3827	77	4724	95	3688	74	4554	91			
					Clear	5488	110	4286	86	5291	106	4131	83	5100	102			
				AS	Diffuse	4372	88	3414	69	4215	85	3291	66	4063	82			
					Clear	4936	99	3855	77	4759	96	3715	75	4587	92			
				WG	Diffuse	5156	104	4026	81	4971	100	3881	78	4791	96			
					Clear	5720	115	4467	90	5515	111	4306	86	5316	107			
				WW	Diffuse	4372	88	3414	69	4215	85	3291	66	4063	82			
					Clear	4936	99	3855	77	4759	96	3715	75	4587	92			
				750	6,000	75	SM	Diffuse	7084	94	5532	74	6830	91	5333	71	6583	88
								Clear	7880	105	6154	82	7597	101	5931	79	7323	97
	AS	Diffuse	6321				84	4936	66	6094	81	4758	63	5874	78			
		Clear	7136				95	5573	74	6880	91	5372	71	6632	88			
	WG	Diffuse	7455				99	5821	77	7187	96	5611	75	6927	92			
		Clear	8270				110	6458	86	7973	106	6225	83	7685	102			
	WW	Diffuse	6321				84	4936	66	6094	81	4758	63	5874	78			
		Clear	7136				95	5573	74	6880	91	5372	71	6632	88			
	1,000	8,000	103				SM	Diffuse	9061	88	7076	68	8736	84	6821	66	8421	81
								Clear	10092	98	7881	76	9730	94	7597	73	9378	91
				AS	Diffuse	8085	78	6314	61	7795	75	6086	59	7513	73			
					Clear	9128	88	7128	69	8800	85	6871	66	8483	82			
				WG	Diffuse	9535	92	7446	72	9192	89	7177	69	8861	86			
					Clear	10578	102	8260	80	10198	99	7962	77	9830	95			
				WW	Diffuse	8085	78	6314	61	7795	75	6086	59	7513	73			
					Clear	9128	88	7128	69	8800	85	6871	66	8483	82			
1,500				12,000	175	SM	Diffuse	12192	70	9521	54	11754	67	9177	52	11330	65	
							Clear	13655	78	10664	61	13165	75	10279	59	12690	73	
	AS	Diffuse	10878			62	8495	49	10488	60	8188	47	10109	58				
		Clear	12282			70	9591	55	11841	68	9245	53	11413	65				
	WG	Diffuse	12829			73	10018	57	12368	71	9657	55	11922	68				
		Clear	14232			81	11114	64	13721	78	10713	61	13226	76				
	WW	Diffuse	10878			62	8495	49	10488	60	8188	47	10109	58				
		Clear	12282			70	9591	55	11841	68	9245	53	11413	65				



JOB
TYPE
NOTES

ELECTRICAL CHARACTERISTICS

Section Length	Lumen Power Level (LM)	Load (A)	System Power (W)	Max Mated Units	Total Feet
2FT	1500	0.357	41.1	28	56
	1000	0.226	26.0	44	88
	750	0.171	19.6	58	116
	500	0.114	13.1	88	150
3FT	1500	0.54	61.2	19	57
	1000	0.335	38.4	30	90
	750	0.25	28.6	40	120
	500	0.166	19.1	60	150
4FT	1500	0.724	81.8	14	56
	1000	0.456	51.8	22	88
	750	0.329	37.8	30	120
	500	0.219	25.0	46	150
6FT	1500	1.097	124.0	9	54
	1000	0.674	76.0	15	90
	750	0.494	56.0	20	120
	500	0.327	37.2	31	150
8FT	1500	1.44	163.1	7	56
	1000	0.901	103.6	11	88
	750	0.656	74.8	15	120
	500	0.432	49.7	23	150

Note: 10A Max Amperage



ARCHITECTURAL AREA LIGHTING
 17760 Rowland Street | City of Industry | CA 91748
 P 626.968.5666 | F 626.369.2695 | www.aal.net
 Copyright © 2018 October 18, 2019 10:04 AM

JOB
TYPE
NOTES

SPECIFICATIONS

HOUSING

- Low copper extruded 6063 aluminum
- Silicone and EPDM gasketing provides comprehensive sealing and ingress protection.
- Luminaire housing shall be free of any visible heat fins, hardware or fasteners.
- Bracketry and hardware shall be stainless steel.

OPTICAL ARRAY

- LEDs shall be mounted to a FR4 printed circuit board assembly.
- Optical lenses shall be clear extruded PMMA acrylic.
- Optical array shall be recessed in order to shield each LED optic across the length of the aperture.
- Light engine is independently IP67 rated to enable luminaire rating of IP66.
- Secondary external lens is 1/16" diffuse acrylic.

ELECTRICAL

- Drivers shall be in direct contact with the extruded aluminum housing across the entire surface area of the widest face for maximum thermal transfer.
- "Thermal Shield", thermistor provides protection for the sustainable life of the LED driver(s) and electronic components.
- Drivers shall have greater than a 0.9 power factor, less than 20% harmonic distortion, and be suitable for operation in -40°C to 40°C ambient environments
- Luminaires shall have integral surge protection that shall be U.L. recognized and have a surge current rating of 10,000 Amps using the industry standard 8/20uSec wave and surge rating of 372J. Surge protection device shall be wired in parallel.
- Drivers shall be U.L. recognized.
- Integral battery backup provides emergency path of egress lighting for the required 90 minutes for -20°C ambient environments, excluding 2' fixture
- Electrical connections IP68
- Housing designed to IP66 standard

END CAPS

- Die-cast, low copper aluminum alloy 360

SPECIFICATIONS

- Luminaire shall be capable of operating at 100% brightness in a 25°C environment. Both driver and optical array shall have integral thermal protection that will dim the luminaire upon detection of temperatures in excess of 85°C.
- Luminaires not configured with a control system shall be provided with 0-10 purple and gray dimming leads.

CONTROLS

- Button photo control for dusk to dawn energy savings
- Photocell is factory installed in accessory housing. For multiple/continuous row applications, one fixture is supplied with a photocell to operate multiple luminaires.
- Dimming Occupancy Sensor-SCP
- SiteSync™ wireless control system for reduction in energy and maintenance cost while optimizing light quality 24/7. See ordering information of visit www.hubbellighting.com/products/sitesync for more details. SiteSync Lighting Control delivers flexible control strategies for reducing power consumption and minimizing maintenance costs while delivering the right light levels with a simple and affordable wireless solution.
- Hubbell Control Solutions' NX Distributed Intelligence™ lighting control platform utilizes a Distributed Network Architecture (DNA) that connects intelligent devices including luminaires, controllers, panels, occupancy sensors, photocells, wall switches and dimmers, creating a system with an unmatched level of reliability, scalability and simplicity

FINISH

- Luminaire finish shall consist of a five stage pretreatment regimen with a polymer primer sealer, oven dry off, and top coated with a thermoset super TGIC polyester powder coat finish.
- Luminaire finish shall meet the AAMA 605.2 performance specification which includes passing a 3000 hour salt spray test for corrosion resistance.

CERTIFICATION

- Luminaire shall be listed with UL for outdoor, wet location use, UL1598, UL 8750 and Canadian CSA Std. C22.2 no.250.
- IP66 rated
- DesignLights Consortium® (DLC) qualified. Please refer to the DLC website for specific product qualifications at www.designlights.org.

WARRANTY / TERMS AND CONDITIONS OF SALE

- Download: Five year limited warranty (for more information visit: [http:// www.hubbellighting.com/resources/warranty/](http://www.hubbellighting.com/resources/warranty/))
- Opening of Component Module on site will void warranty.

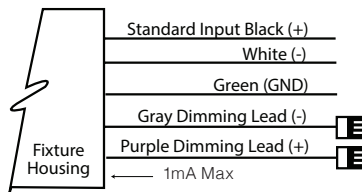

ARCHITECTURAL AREA LIGHTING
 17760 Rowland Street | City of Industry | CA 91748
 P 626.968.5666 | F 626.369.2695 | www.aal.net
 Copyright © 2018 October 18, 2019 10:04 AM

JOB _____
 TYPE _____
 NOTES _____