

# LCAT22

2' x 2' LED CONTEMPORARY ARCHITECTURAL TROFFER

## FEATURES

- High efficiency acrylic center lens features linear prisms for high performance without pixelation
- Appropriate for offices, schools, medical, and public spaces
- High performance reflector with matte white paint standard
- HE lumen packages available
- LED modules and electrical accessible from below
- Optional architecturally styled integration of daylight and occupancy sensor(s)
- QR code traceability
- Compatible with Dual-Lite inverters



## CONTROL TECHNOLOGY



## SPECIFICATIONS

### CONSTRUCTION

- Luminaire housing, reflectors and end caps are die-formed code-gauge cold-rolled steel
- High transmission extruded acrylic enclosed lens features linear prisms with custom frost for high efficacy without pixelation
- All reflective surfaces are finished after fabrication with unique formula high-reflectivity matte white paint for soft, uniform indirect illumination

### OPTICS

- Removable lens for easy access to LED module and electrical components

### INSTALLATION

- An access plate is furnished with each luminaire for fast wiring access without the necessity to open the fixture or wireway
- Luminaire fits recessed exposed Grid ceilings (G); four integral NEC compliant T-bar clips are standard
- Can be placed in Slot Grid (SG) style ceiling with regress 3/8" above ceiling plane
- A Flange Kit (FK) accessory is available for recessed hard ceiling applications
- Surface Mount (SM) option allows placement below ceiling plane
- Cable Mount (CM) option allows suspension below ceiling plane

### ELECTRICAL

- 60,000 hour LEDs at L80 (up to 150,000 projected life) for reduced maintenance
- 83 CRI standard or optional 90 CRI for color sensitive applications

### CONTROLS

- Optional SpectraSync™ offers two modes of Tunable White solutions and integrates seamlessly into a variety of control systems
- NX Distributed Intelligence™ provides options for standalone and networked integrated sensor with wired or wireless connectivity for NX system deployments

### CERTIFICATIONS

- IC label is standard for recessed products. Note that IC label is void if product is installed on site with a combination of both battery pack plus through wiring or for air return fixtures
- All luminaires are built to UL1598 and 2108 standards, and bear appropriate cCSAus labels
- Damp Location label standard
- Adheres to LM79, LM80, and TM21 industry standards

## RELATED PRODUCTS

- [⌀ LCAT12](#)   
 [⌀ LCAT14](#)   
 [⌀ LCAT24](#)

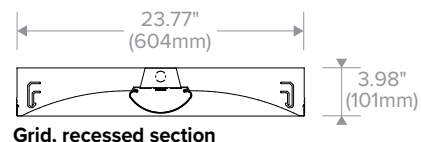

### CERTIFICATIONS (CONTINUED)

- DLC® (DesignLights Consortium) Qualified, with some Premium Qualified configurations. Please refer to the DLC website for specific product qualifications at [www.designlights.org](http://www.designlights.org)
- NX is available in U.S., Canada and Mexico. For other locations consult factory
- The DTS, Dimming Bypass Module, is for emergency circuit control loads including sensors and wireless systems listed to UL924. See page 8 for wiring diagram. [Link to Dimming Bypass Module Specification sheet](#)

### WARRANTY

- 5 year warranty
- See [HLI Standard Warranty](#) for additional information

KEY DATA	
Lumen Range	1313–4863
Wattage Range	13–40
Efficacy Range (LPW)	93–139
Reported Life (Hours)	L80/60,000
Input Current Range (mA)	46–333



# LCAT22

2' x 2' LED CONTEMPORARY ARCHITECTURAL TROFFER

## ORDERING GUIDE

Example: LCAT22-35MLG-ESDU

CATALOG # \_\_\_\_\_

LCAT22								
Model	CRI	Color Temp	Delivered Lumens	Ceiling Type	Shielding	Air Function	Driver	
LCAT22 2' x 2' LED Contemporary Architectural Troffer	Blank	>80	30 3000K	VW 1313-1785	G Grid Lay-in <sup>3</sup>	Blank	Blank	E Fixed Output
	9	>90 <sup>1</sup>	35 3500K	VWHE 1530-1743	SM Surface Mount <sup>4,10</sup>	Curve Rectangular	A	ED 0-10V Dimming
		40 4000K	MW 1714-2334	CM Cable Suspended Mount <sup>4,5</sup>	Static		ED1 0-10V 1% Dimming	
	50	5000K	MWHE 2010-2289	LW 2263-3063	ML 2778-3781	A	Air Return Side Slots	EDD 0-10V Dim-to-Dark
		2750T	2700K-5000K SpectraSync™ Tunable White <sup>2</sup>	MLHE 3293-3751				ESD Step Dimming <sup>6,8,11</sup>
	2765T	2700K-6500K SpectraSync™ Tunable White <sup>2</sup>	HL 3012-4099	HLHE 3616-3769	HLHE 3616-3769	A	Air Return Side Slots	LUTH Hi-lume 1% EcoSystem LED driver with Soft-on, Fade-to-Black dimming technology <sup>6,8,11</sup>
			VL 3767-4863	VLHE 4257-4649	VLHE 4257-4649			LUT5 5-Series EcoSystem LED driver <sup>6,8,11</sup>
								DALIP DALI P driver <sup>14</sup>

Voltage	Options	Control Options
U 120-277V	ELL14 Emergency Battery Pack Installed, 1400 Lumens <sup>7,8</sup>	<b>NX Standalone</b>
347 347V <sup>12</sup>	DTS Dimming Bypass Module <sup>9</sup>	NXS NX, PIR BT Occupancy/Daylight Sensor, Slide Mount <sup>11,12</sup>
	C388 3-wire Flex <sup>13</sup>	<b>NX Networked – Wired</b>
	C488 4-wire Flex <sup>13</sup>	NXE NX, Dual SmartPORTs <sup>11,12</sup>
	C588 5-wire Flex <sup>13</sup>	NXES NX, PIR BT Occupancy/Daylight Sensor, Slide Mount, Dual SmartPORTs <sup>11,12</sup>
	GLR Fast Blow Fuse	<b>NX Networked – Wireless</b>
	EOR End of Row (SM and CM only. Provides end wiring access for continuous row mounting.) <sup>4</sup>	NXSW NX Wireless, PIR BT Occupancy/Daylight Sensor <sup>10,11,12</sup>
	INT Intermediate (SM and CM only. Provides ends with wiring access for continuous row mounting.) <sup>4</sup>	NXWE NX Wireless Enabled <sup>10,11,12</sup>
	CP Chicago Plenum	<b>NX Networked – Wired/Wireless Hybrid</b>
		NXSWD NX Wireless, PIR BT Occupancy/Daylight Sensor, Dual SmartPORTs <sup>11,12</sup>
		NXWD NX Wireless, Dual SmartPORTs <sup>11,12</sup>
		<b>Third-Party Control Options</b>
		ODPG Occupancy and Daylight Sensors w/ Grouping, Philips SNS200 <sup>8,14,18</sup>
		LV Lutron VIVE Attached FCJS POWPAK Fixture Control (RF only for 0-10V drivers) <sup>15,16,17,18</sup>
		LVR Lutron VIVE Integral Fixture Control DFCSJ-OEM-RF (RF only) <sup>14,16,18</sup>
		LVS Lutron VIVE Integral Fixture Control DFCSJ-OEM-OCC (RF with daylight and occupancy sensing) <sup>14,16,18</sup>
		ZRE ControlScope® compatible <sup>18,19</sup>

### Accessories

- FK22** 2' x 2' Single Flange Kit (Shipped separately)
- CM48Y2SC3F-KIT** 48" Cable Mount Kit for 2' wide Cable Mount fixtures, 3-wire

### Notes:

- 1 Not available with HE lumen output
  - 2 Available with ED driver and 80 CRI only. Not available with HE or VL lumen outputs or ODPG sensor option
  - 3 For drywall, order G with Flange Kit Accessory
  - 4 Not available with Air Return (A) air function
  - 5 Order hanger accessories separately
  - 6 Limitations apply based on lumen packages (see [Product Exceptions & Details](#))
  - 7 For compatibility with Dual-Lite LiteGear® inverters, contact Hubbell Lighting Representative
  - 8 Not available in 347V.
  - 9 For emergency circuit control loads including sensors and wireless systems listed to UL924. Only available with 0-10V drivers. Universal voltage only. See page 8 for wiring diagram
  - 10 NXSW, NXWE, NXSWD and NXWD cannot be used with surface mount versions
  - 11 NX is not available with ESD, LUTH, LUT5 or DALIP driver options
  - 12 NX combined with Spectrasync is not available in 347V
  - 13 For NX control and Flex Wire together, consult factory
  - Third-Party Control Options**
  - 14 LVS, LVR and ODPG only available with DALIP driver option
  - 15 Not available with E, ESD, LUTH or LUT5
  - 16 VIVE is a trademark of Lutron Electronics Co., Inc
  - 17 Installations controlled solely by the Lutron Pico controller require accessing the LV (Lutron FCJS) module for commissioning after the circuit has been energized
  - 18 Not available with SpectraSync (2750T or 2765T)
  - 19 Registered trademark of Daintree Networks, used by permission
- For questions about configuration options, contact Hubbell Representative



# LCAT22

2' x 2' LED CONTEMPORARY ARCHITECTURAL TROFFER

DATE:	LOCATION:
TYPE:	PROJECT:
CATALOG #:	

## PRODUCT EXCEPTIONS & DETAILS

Driver options listed below are available for the outputs as shown.

DRIVER AVAILABILITY TABLE											
	VW	VWHE	MW	MWHE	LW	ML	MLHE	HL	HLHE	VL	VLHE
E	X	X	X	X	X	X	X	X	X	X	X
ED	X	X	X	X	X	X	X	X	X	X	X
ED1	X	X	X	X	X	X	X	X	X	X	X
EDD			X		X	X		X			
ESD			X		X	X		X		X	
LUT5			X		X	X					
LUTH			X		X	X					
347	X		X		X	X		X		X	

## CONTROLS

### NX Distributed Intelligence™ Lighting Controls:

Supports both indoor and outdoor applications in a variety of deployment options- wired, wireless, hybrid. Integrates with and enables a wide array of luminaires including those with SpectraSync™ Color Tuning Technology.



NX INTEGRATED CONTROLS REFERENCE								
NX Option	Sensor	Networkable	Scheduling	Occupancy	Daylight Harvesting	0-10V Dimming	On/off Control	Bluetooth® App Programming
<b>NX Standalone</b>								
<a href="#">NXS</a>	<a href="#">NXSMP-SMI</a>	No	Yes	Yes	Yes	Yes	Yes	Yes
<b>NX Networked – Wired</b>								
<a href="#">NXE</a>	N/A	Yes	Yes	No	No	Yes	Yes	Requires <a href="#">NXBTC/R</a> <sup>1</sup>
<a href="#">NXES</a>	<a href="#">NXSMP-SMI</a>	Yes	Yes	Yes	Yes	Yes	Yes	Yes
<b>NX Networked – Wireless</b>								
<a href="#">NXSW</a>	<a href="#">NXSMP-SMI</a>	Yes	Yes	Yes	Yes	Yes	Yes	Yes
<a href="#">NXWE</a>	N/A	Yes	Yes	No	No	Yes	Yes	No <sup>2</sup>
<b>NX Networked – Wired/Wireless</b>								
<a href="#">NXSWD</a>	<a href="#">NXSMP-SMI</a>	Yes	Yes	Yes	Yes	Yes	Yes	Yes
<a href="#">NXWD</a>	N/A	Yes	Yes	No	No	Yes	Yes	Requires <a href="#">NXBTC/R</a> <sup>1,2</sup>

1 NXBTC/R needs to be plugged into an available NX SmartPORT™ on the fixture network  
 2 To program NXWE option, need to consult factory. If connected to an area controller, programming can be done from that

### Philips EasySense Controls ODPG Sensor:



- Occupancy sensing, daylight harvesting, task tuning and grouping in one device
- Standalone control or grouping to wireless switches<sup>1</sup>
- Uses Philips field apps for on site commissioning<sup>2,3</sup>
- Ability to create scenes for various room configurations
- Cost-effective solution for energy-savings and code-compliance strategies
- DLC® Qualified: Listed on the GPL for Networked Lighting Controls. Please refer to the DLC website for specific product qualifications at [www.designlights.org](http://www.designlights.org)

1 Wireless switches only compatible with ODPG Philips EasySense  
 2 [See link to Philips commissioning](#)  
 3 Requires android device or IR dongle. See links for [phone compatibility](#) and [IR dongle](#)

### Wireless Switch Accessories<sup>1</sup>

- [PESR-WH](#) EasySense compatible wireless single rocker switch, white
- [PEDR-WH](#) EasySense compatible wireless dual rocker switch, white



# LCAT22

2' x 2' LED CONTEMPORARY ARCHITECTURAL TROFFER

DATE:	LOCATION:
TYPE:	PROJECT:
CATALOG #:	

## CONTROLS (CONTINUED)

### SpectraSync™ Color Tuning Technology:

Control your space based on the needs of the application, specific activities throughout the day and preferences of the occupants with distinct SpectraSync™ Color Tuning Technologies.



SPECTRASYNC COLOR TUNING TECHNOLOGY		
Mode	Kelvin Range	Description
Tunable White	2700K–5000K 2700K–6500K	Offers users the ability to tailor CCT to their personal preference, enhancing task visibility, material and colors or the aesthetics of the space

### SpectraSync Tunable White

Available in two options: 2750T (2700K–5000K) or 2765T (2700K–6500K). Requires two 0–10V controllers, one for intensity and one for CCT. Minimum 5% dimming.

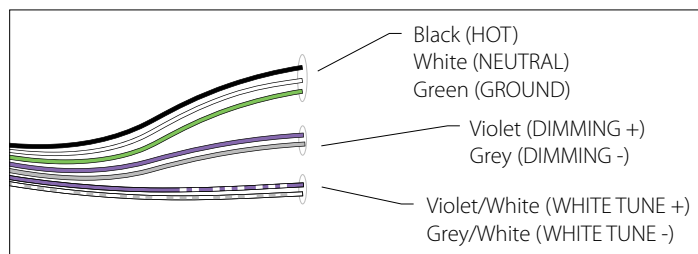

SpectraSync Tunable White luminaires are provided with two 0–10V circuits. The violet and grey circuit is for wiring to any qualified 0–10V controller for dimming. The violet/white and grey/white circuit is for wiring to any qualified 0–10V controller for Tunable White CCT control.

### Controller Manufacturer Data

SpectraSync Tunable White was designed to be used with sinking style dimmers (provided by others) and is compatible with:

- Hubbell Control Solutions (HCS): NX Distributed Intelligence™ Room Controllers (NXRC) and In-fixture Controllers (NXFM)
- Lutron: DDTV, DVSTV, and NFTV dimmers
- Wattstopper: ADF120277 and CD4BL (Titan) dimmers

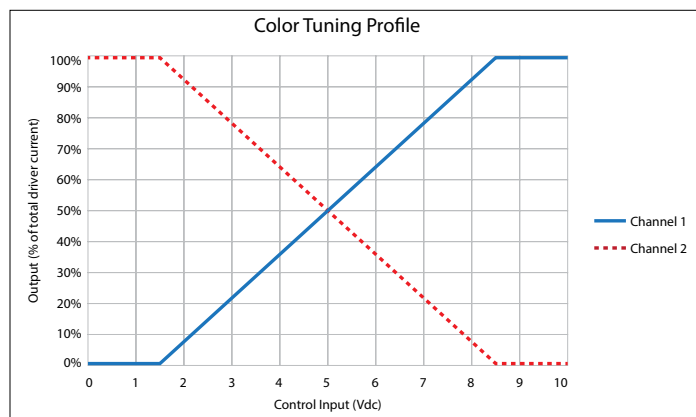

To enable scheduling and for use with NX wall control preset stations please refer to Hubbell Control Solutions NX SpectraSync technical sheet.

## DELIVERED LUMENS, SPECTRASYNC™



Shielding	Lumen Output	Watts	2700		3000		3500		4000		5000		6500	
			Lumens	LPW	Lumens	LPW	Lumens	LPW	Lumens	LPW	Lumens	LPW	Lumens	LPW
Curve	VW	14	1500	110	1567	115	1595	117	1616	119	1669	123	1644	121
	MW	18	1961	109	2049	114	2086	116	2113	117	2182	121	2149	119
	LW	23	2582	114	2698	119	2747	122	2782	123	2873	127	2830	125
	ML	29	3177	111	3320	116	3380	118	3423	119	3536	123	3483	121
	HL	32	3444	108	3599	113	3664	115	3711	117	3833	121	3775	119
Rectangle	VW	13	1479	110	1545	115	1573	117	1593	119	1645	123	1621	121
	MW	18	1930	109	2017	114	2053	116	2080	117	2148	121	2116	120
	LW	23	2547	113	2661	118	2709	120	2743	121	2834	125	2791	124
	ML	29	3127	109	3267	114	3326	116	3368	117	3479	121	3427	119
	HL	32	3391	107	3543	112	3607	114	3653	116	3773	119	3717	118



# LCAT22

2' x 2' LED CONTEMPORARY ARCHITECTURAL TROFFER

DATE: \_\_\_\_\_ LOCATION: \_\_\_\_\_

TYPE: \_\_\_\_\_ PROJECT: \_\_\_\_\_

CATALOG #: \_\_\_\_\_

## DELIVERED LUMENS

Product Availability 80 CRI				
Lumen Package	Shielding	Lumens	Input Watts	LPW
LCAT22-30VW	Curve	1567	14	115
LCAT22-30VWx-R	Rectangle	1545	13	115
LCAT22-30VWHE	Curve	1530	13	121
LCAT22-35VW	Curve	1614	14	119
LCAT22-35VWx-R	Rectangle	1597	13	119
LCAT22-35VWHE	Curve	1576	13	125
LCAT22-40VW	Curve	1639	14	121
LCAT22-40VWx-R	Rectangle	1623	13	121
LCAT22-40VWHE	Curve	1600	13	127
LCAT22-50VW	Curve	1785	14	131
LCAT22-50VWx-R	Rectangle	1666	13	124
LCAT22-50VWHE	Curve	1743	13	138
LCAT22-30MW	Curve	2049	18	114
LCAT22-30MWx-R	Rectangle	2017	18	114
LCAT22-30MWHE	Curve	2010	17	122
LCAT22-35MW	Curve	2110	18	117
LCAT22-35MWx-R	Rectangle	2085	18	118
LCAT22-35MWHE	Curve	2070	17	125
LCAT22-40MW	Curve	2143	18	119
LCAT22-40MWx-R	Rectangle	2118	18	120
LCAT22-40MWHE	Curve	2102	17	127
LCAT22-50MW	Curve	2334	18	130
LCAT22-50MWx-R	Rectangle	2174	18	123
LCAT22-50MWHE	Curve	2289	17	139
LCAT22-30LW	Curve	2689	23	119
LCAT22-30LWx-R	Rectangle	2661	23	118
LCAT22-35LW	Curve	2770	23	123
LCAT22-35LWx-R	Rectangle	2752	23	122
LCAT22-40LW	Curve	2813	23	124
LCAT22-40LWx-R	Rectangle	2795	23	124
LCAT22-50LW	Curve	3063	23	136
LCAT22-50LWx-R	Rectangle	2870	23	127
LCAT22-30ML	Curve	3320	29	116
LCAT22-30MLx-R	Rectangle	3267	29	114
LCAT22-30MLHE	Curve	3293	28	119
LCAT22-35ML	Curve	3420	29	119
LCAT22-35MLx-R	Rectangle	3378	29	118
LCAT22-35MLHE	Curve	3392	28	123
LCAT22-40ML	Curve	3473	29	121
LCAT22-40MLx-R	Rectangle	3431	29	120
LCAT22-40MLHE	Curve	3442	28	125
LCAT22-50ML	Curve	3781	29	132
LCAT22-50MLx-R	Rectangle	3522	29	123
LCAT22-50MLHE	Curve	3751	28	136
LCAT22-30HL	Curve	3599	32	113
LCAT22-30HLx-R	Rectangle	3543	32	112
LCAT22-30HLHE	Curve	3497	28	126
LCAT22-35HL	Curve	3707	32	117
LCAT22-35HLx-R	Rectangle	3664	32	116
LCAT22-35HLHE	Curve	3616	28	130
LCAT22-40HL	Curve	3764	32	118
LCAT22-40HLx-R	Rectangle	3721	32	118
LCAT22-40HLHE	Curve	3671	28	132
LCAT22-50HL	Curve	4099	32	129
LCAT22-50HLx-R	Rectangle	3820	32	121
LCAT22-50HLHE	Curve	3769	28	136

Product Availability 90 CRI				
Lumen Package	Shielding	Lumens	Input Watts	LPW
LCAT22-930VW	Curve	1342	13	100
LCAT22-930VWx-R	Rectangle	1313	13	98
-	-	-	-	-
LCAT22-935VW	Curve	1371	13	102
LCAT22-935VWx-R	Rectangle	1341	13	100
-	-	-	-	-
LCAT22-940VW	Curve	1400	13	104
LCAT22-940VWx-R	Rectangle	1370	13	102
-	-	-	-	-
LCAT22-950VW	Curve	1492	13	111
LCAT22-950VWx-R	Rectangle	1459	13	109
-	-	-	-	-
LCAT22-930MW	Curve	1744	17.7	99
LCAT22-930MWx-R	Rectangle	1714	17.7	97
-	-	-	-	-
LCAT22-935MW	Curve	1781	18	101
LCAT22-935MWx-R	Rectangle	1750	18	99
-	-	-	-	-
LCAT22-940MW	Curve	1819	18	103
LCAT22-940MWx-R	Rectangle	1788	18	101
-	-	-	-	-
LCAT22-950MW	Curve	1938	18	109
LCAT22-950MWx-R	Rectangle	1905	18	108
-	-	-	-	-
LCAT22-930LW	Curve	2286	23	101
LCAT22-930LWx-R	Rectangle	2263	23	100
LCAT22-935LW	Curve	2339	23	103
LCAT22-935LWx-R	Rectangle	2311	23	102
LCAT22-940LW	Curve	2393	23	106
LCAT22-940LWx-R	Rectangle	2361	23	104
LCAT22-950LW	Curve	2527	23	112
LCAT22-950LWx-R	Rectangle	2515	23	111
LCAT22-930ML	Curve	2821	29	98
LCAT22-930MLx-R	Rectangle	2778	29	97
-	-	-	-	-
LCAT22-935ML	Curve	2888	29	101
LCAT22-935MLx-R	Rectangle	2836	29	99
-	-	-	-	-
LCAT22-940ML	Curve	2954	29	103
LCAT22-940MLx-R	Rectangle	2897	29	101
-	-	-	-	-
LCAT22-950ML	Curve	3121	29	109
LCAT22-950MLx-R	Rectangle	3086	29	108
-	-	-	-	-
LCAT22-930HL	Curve	3123	32	98
LCAT22-930HLx-R	Rectangle	3012	32	95
-	-	-	-	-
LCAT22-935HL	Curve	3190	32	100
LCAT22-935HLx-R	Rectangle	3076	32	97
-	-	-	-	-
LCAT22-940HL	Curve	3259	32	102
LCAT22-940HLx-R	Rectangle	3142	32	99
-	-	-	-	-
LCAT22-950HL	Curve	3471	32	109
LCAT22-950HLx-R	Rectangle	3347	32	106
-	-	-	-	-

(Tables continue on next page.)



# LCAT22

2' x 2' LED CONTEMPORARY ARCHITECTURAL TROFFER

DATE: \_\_\_\_\_ LOCATION: \_\_\_\_\_

TYPE: \_\_\_\_\_ PROJECT: \_\_\_\_\_

CATALOG #: \_\_\_\_\_

## DELIVERED LUMENS, CONT'D

Product Availability 80 CRI				
Lumen Package	Shielding	Lumens	Input Watts	LPW
LCAT22-30VL	Curve	4270	39	111
LCAT22-30VLx-R	Rectangle	4432	40	110
LCAT22-30VLHE	Curve	4257	35	123
LCAT22-35VL	Curve	4398	39	114
LCAT22-35VLx-R	Rectangle	4583	40	113
LCAT22-35VLHE	Curve	4401	35	127
LCAT22-40VL	Curve	4466	39	116
LCAT22-40VLx-R	Rectangle	4655	40	115
LCAT22-40VLHE	Curve	4470	35	129
LCAT22-50VL	Curve	4863	39	126
LCAT22-50VLx-R	Rectangle	4779	40	118
LCAT22-50VLHE	Curve	4649	35	134

Product Availability 90 CRI				
Lumen Package	Shielding	Lumens	Input Watts	LPW
LCAT22-930VL	Curve	4289	39	110
LCAT22-930VLx-R	Rectangle	3767	40	93
-	-	-	-	-
LCAT22-935VL	Curve	4381	39	113
LCAT22-935VLx-R	Rectangle	3848	40	95
-	-	-	-	-
LCAT22-940VL	Curve	4476	39	115
LCAT22-940VLx-R	Rectangle	3930	40	97
-	-	-	-	-
LCAT22-950VL	Curve	4767	39	123
LCAT22-950VLx-R	Rectangle	4187	40	104
-	-	-	-	-

# LCAT22

2' x 2' LED CONTEMPORARY ARCHITECTURAL TROFFER

DATE: \_\_\_\_\_ LOCATION: \_\_\_\_\_  
 TYPE: \_\_\_\_\_ PROJECT: \_\_\_\_\_  
 CATALOG #: \_\_\_\_\_

## DIMENSIONS

### GRID

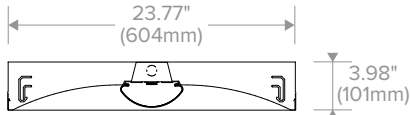

Grid, recessed section

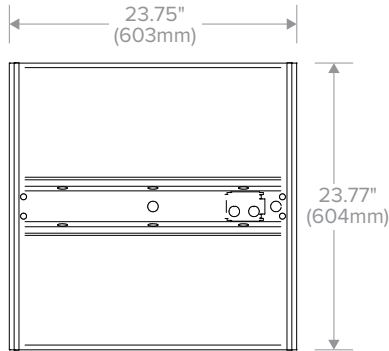

Grid, back of housing

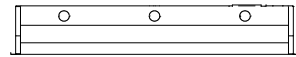

### GRID, STATIC

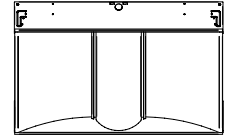
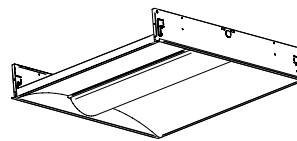

### GRID, AIR RETURN

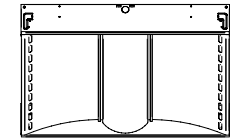
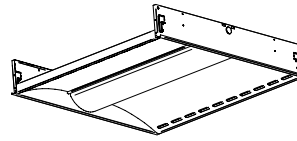

## CEILING COMPATIBILITY

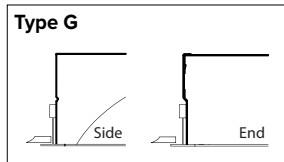

For lay-in installation in exposed grid ceilings. Maximum tee widths of 1" and maximum tee heights of 2" allowed.

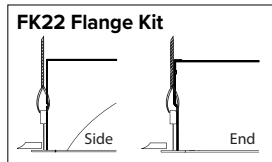

For hard ceiling applications, order FK22 flange kit. Flange kit wires directly into concealed ceiling opening for a clean, finished appearance.

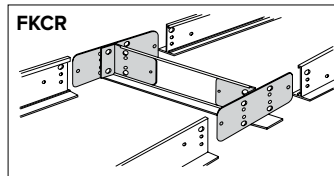

For flanged fixtures in row configurations, the FKCR adapter bracket kit is required in addition to the FK22 kit. Order one less FKCR than the total number of fixtures in row. (Example: Row of two, order (2) FK22 & (1) FKCR)

Row cut out dimensions using FK22s & FKCR adapters: Width 24 3/8", Length [24" x (# in row)] + 3/8". Example: (24" x 2) + 3/8" = 48 3/8"

Flange kit cut out dimension for single unit only: 24 3/8" x 24 3/8"

## SURFACE MOUNT OR CABLE MOUNT, STATIC ONLY

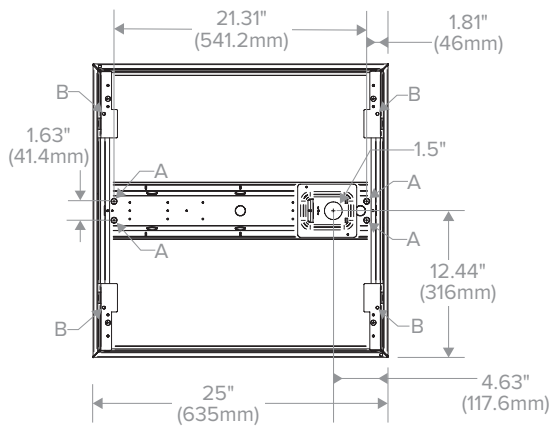

Surface Mount (SM) and Cable Mount (CM), back of housing

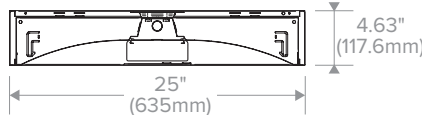

Surface section (SM)

### Surface Mount:

Order SM ceiling type. Mounting collar required for surface mounting. (4) Mounting knock-outs, 3/8", provided in center channel as indicated at left, marked A.

### Cable Mount:

Order CM ceiling type. Use CM48Y2SC3F-KIT 48" Cable Mount Kit for 2' wide CM trim fixtures. Mounting holes are provided in diagonal straps shown at left, marked B.

\* For Cable Mount a 2' x 3" access plate with (4) 3/8" KOs provided in place of Mounting Collar shown.

NOTE: All dimensions are in inches; dimensions and specifications are subject to change without notice. Please consult factory or check sample for verification.

# LCAT22

2' x 2' LED CONTEMPORARY ARCHITECTURAL TROFFER

## PHOTOMETRY

### LCAT22-35LWG-EU

#### LUMINAIRE DATA

Test No.	16540
Description	2' x 2' LED architectural troffer with frosted linear prisms lens
Delivered Lumens	2769
Watts	22.60
Efficacy	123
Mounting	Recessed
Spacing Criterion	0° = 1.19 90° = 1.31

#### ZONAL LUMEN SUMMARY

Zone	Lumens	% Luminaire
0-30	705	25.5
0-40	1154	41.7
0-60	2056	74.3
0-90	2769	100
0-180	2769	100

#### POLAR GRAPH

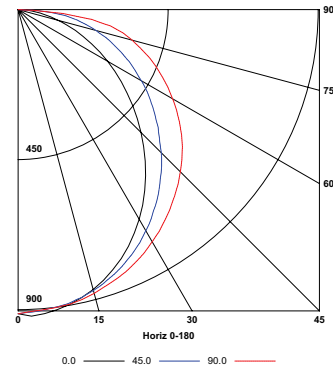

### LCAT22-35MLG-EU

#### LUMINAIRE DATA

Test No.	16543
Description	2' x 2' LED architectural troffer with frosted linear prisms lens
Delivered Lumens	3420
Watts	28.70
Efficacy	119
Mounting	Recessed
Spacing Criterion	0° = 1.19 90° = 1.31

#### ZONAL LUMEN SUMMARY

Zone	Lumens	% Luminaire
0-30	871	25.5
0-40	1424	41.7
0-60	2539	74.2
0-90	3420	100
0-180	3420	100

#### POLAR GRAPH

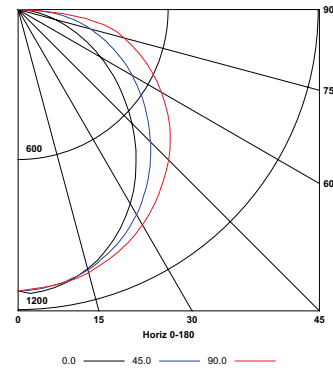

### LCAT22-35HLG-EU

#### LUMINAIRE DATA

Test No.	16546
Description	2' x 2' LED architectural troffer with frosted linear prisms lens
Delivered Lumens	3707
Watts	31.80
Efficacy	117
Mounting	Recessed
Spacing Criterion	0° = 1.19 90° = 1.31

#### ZONAL LUMEN SUMMARY

Zone	Lumens	% Luminaire
0-30	943	25.4
0-40	1543	41.6
0-60	2751	74.2
0-90	3707	100
0-180	3707	100

#### POLAR GRAPH

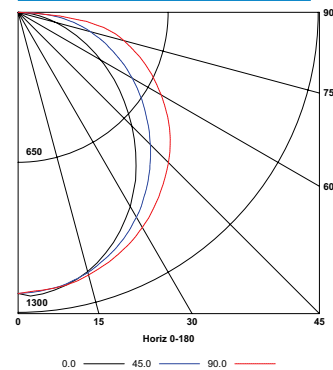

## ADDITIONAL INFORMATION

### DTS WIRING DIAGRAM (0-10V DIMMING DRIVER SHOWN)

