

TCAT22

2' x 2' LED TWIN CONTEMPORARY ARCHITECTURAL TROFFER

DATE:	LOCATION:
TYPE:	PROJECT:
CATALOG #:	

FEATURES

- High efficiency acrylic lenses feature custom formulation for high performance without pixelation
- Appropriate for offices, schools, medical, and public spaces
- LED modules and electrical accessible from below
- Optional architecturally styled integration of daylight and occupancy sensor(s)
- Compatible with Dual-Lite inverters

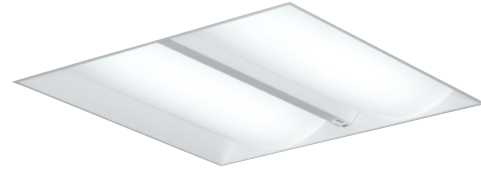

CONTROL TECHNOLOGY



RELATED PRODUCTS

- [TCAT14](#)
- [TCAT22](#)

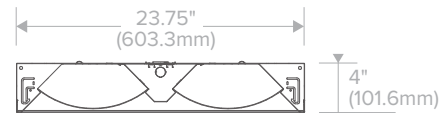

Grid, recessed section

SPECIFICATIONS

CONSTRUCTION

- Luminaire housing, reflectors and end caps are die formed code gauge cold rolled steel
- Removable lenses and center channel for easy access to LED module and electrical components
- All reflective surfaces are finished after fabrication with unique formula high reflectivity matte white paint for soft, uniform illumination

OPTICS

- High transmission extruded acrylic lenses feature custom formulation for high efficacy without pixelation

INSTALLATION

- An access plate is furnished with each luminaire for fast wiring access without the necessity to open the fixture or wireway
- Luminaire fits recessed exposed Grid ceilings (G); four integral NEC compliant T-bar clips are standard
- Can be placed in Slot Grid (SG) style ceiling with regress 3/8" above ceiling plane
- A Flange Kit (FK) accessory is available for recessed hard ceiling applications
- Surface Mount (SM) option allows placement below ceiling plane
- Cable Mount (CM) option allows suspension below ceiling plane

CONTROLS

- Optional SpectraSync™ offers two modes of Tunable White solutions and integrates seamlessly into a variety of control systems
- NX Distributed Intelligence™ provides options for standalone and networked integrated sensor with wired or wireless connectivity for NX system deployments

CERTIFICATIONS

- IC label is standard for recessed products
- All luminaires are built to UL1598 and 2108 standards, and bear appropriate CSA labels
- Damp location label standard
- Emergency-equipped fixtures are Dry Location unless specified
- CSA certified to UL 924 standards with battery pack or DTS (Dimming Bypass Module) options
- Adheres to LM79, LM80, and TM21 industry standards
- DLC® (DesignLights Consortium) Qualified, with some Premium Qualified configurations. Please refer to the DLC website for specific product qualifications at www.designlights.org
- NX is available in U.S., Canada and Mexico. For other locations consult factory

CERTIFICATIONS (CONTINUED)

- The DTS, Dimming Bypass Module, is for emergency circuit control loads including sensors and wireless systems CSA certified to UL 924. See page 7 for wiring diagram. [Link to Dimming Bypass Module Specification sheet](#)

WARRANTY

- 5 year warranty
- See [HLI Standard Warranty](#) for additional information

KEY DATA	
Lumen Range	1400–4600
Wattage Range	12–37
Efficacy Range (LPW)	109–135
Reported Life (Hours)	L80/60,000
Input Current Range (mA)	40–310

TCAT22

2' x 2' LED TWIN CONTEMPORARY ARCHITECTURAL TROFFER

DATE: _____ LOCATION: _____

TYPE: _____ PROJECT: _____

CATALOG #: _____

ORDERING GUIDE

Example: TCAT22-35HLG-ESDU

CATALOG #

TCAT22	Color Temp		Delivered Lumens		Ceiling Type		Driver		Voltage		
Model											
TCAT22 2' x 2' LED Contemporary Architectural Troffer	30	3000K	VW	1400-1500	G	Grid Lay-in ²	E	Fixed Output ¹⁰	U	120-277V	
	35	3500K	MW	2075-2350	SM	Surface Mount ⁹	ED	0-10V Dimming	347	347V ¹¹	
	40	4000K	LW	2525-2875	CM	Cable Suspended Mount ²	ED1	0-10V 1% Dimming			
	50	5000K	ML	3375-3825			ESD	Step Dimming ^{4,10}			
	2750T	2700K-5000K SpectraSync™ Tunable White ¹	HL	3850-4050			LUTH	Hi-lume 1% EcoSystem LED driver with Soft-on, Fade-to-Black dimming technology ^{4,5,10}			
	2765T	2700K-6500K SpectraSync™ Tunable White ¹	VL	4300-4625 ⁸			LUT5	5-Series EcoSystem LED driver ^{4,5,10}			
							DALIP	DALI Power Bus ⁶			

Options	Control Options
ELL14 Emergency Battery Pack Installed, 1400 Lumens ^{4,5}	<u>NX Standalone</u>
DTS Dimming Bypass Module ⁷	NXS NX, PIR Occupancy Sensor, Dimming Daylight Harvesting ^{10,11,13}
C388 3-Wire Flex ¹²	<u>NX Networked – Wired</u>
C488 4-Wire Flex ¹²	NXE NX Enabled, Dual SmartPorts ^{10,11,13}
C588 5-Wire Flex ¹²	NXES NX Enabled, PIR Occupancy Sensor, Dimming Daylight Harvesting ^{10,11,13}
GLR Fast Blow Fuse	<u>NX Networked – Wireless</u>
EOR End of Row (SM and CM only. Provides end wiring access for continuous row mounting.)	NXSW NX Wireless, PIR Occupancy Sensor, Dimming Daylight Harvesting ^{9,10,11,13}
INT Intermediate (SM and CM only. Provides ends with wiring access for continuous row mounting.)	NXWE NX Wireless Enabled ^{9,10,11,13}
CP Chicago Plenum	<u>Third-Party Control Options</u>
	ODPG Occupancy and Daylight Sensors w/ Grouping, Philips ^{4,14,18}
	LV Lutron VIVE Attached FCJS POWPAK Fixture Control (RF only for 0-10V drivers) ^{15,16,17,18}
	LVS Lutron VIVE Integral Fixture Control DFCSJ-OEM-OCC (RF with daylight and occupancy sensing) ^{14,16,18}
	LVR Lutron VIVE Integral Fixture Control DFCSJ-OEM-RF (RF only) ^{14,16,18}

Accessories

- FK22** 2' x 2' Single Flange Kit (Shipped separately)
- CM48Y2SC3F-KIT** 48" Cable Mount Kit for 2' wide Cable Mount fixtures, 3-wire

Notes:

- 1 Only available with 0-10V Dimming (ED) Driver Option. See page 4 for more information
- 2 For drywall, order G with Flange Kit Accessory
- 3 Order hanger accessories separately
- 4 Not available in 347V
- 5 For compatibility with Dual-Lite LiteGear® inverters, contact Hubbell Lighting Representative
- 6 DALIP only available when LVS, LVR or ODPG control options are selected
- 7 For emergency circuit control loads including sensors and wireless systems CSA certified to UL 924. Only available with 0-10V drivers. Universal voltage only. See page 7 for wiring diagram

NX In-Fixture Control Options:

- 8 NX control function not available with VL lumen output
- 9 NXSW, NXWE, NXE and NXES cannot be used with surface mount versions

- 10 NX is available with ED and ED1 drivers only
- 11 NX combined with Spectrasync is not available in 347V
- 12 For NX control and Flex Wire together, consult factory
- 13 NX controls can only be used with NX Sensor options

Third-Party Control Options:

- 14 LVS, LVR and ODPG only available with DALIP driver option
- 15 Only available with ED driver option
- 16 VIVE is a trademark of Lutron Electronics Co., Inc
- 17 Installations controlled solely by the Lutron Pico controller require accessing the LV (Lutron FCJS) module for commissioning after the circuit has been energized
- 18 Not available with SpectraSync (2750T or 2765T)

For questions about configuration options, contact Hubbell Representative

TCAT22

2' x 2' LED TWIN CONTEMPORARY ARCHITECTURAL TROFFER

DATE:	LOCATION:
TYPE:	PROJECT:
CATALOG #:	

PRODUCT EXCEPTIONS & DETAILS

Driver options listed below are available for the outputs as shown.

DRIVER AVAILABILITY TABLE						
	VW	MW	LW	ML	HL	VL
E	X	X	X	X	X	X
ED	X	X	X	X	X	X
ED1	X	X	X	X	X	X
ESD				X	X	X
LUT5			X	X	X	X
LUTH			X	X	X	X

CONTROLS

NX Distributed Intelligence™ Lighting Controls:

Supports both indoor and outdoor applications in a variety of deployment options- wired, wireless, hybrid. Integrates with and enables a wide array of luminaires including those with SpectraSync™ Color Tuning Technology.



NX INTEGRATED CONTROLS REFERENCE								
NX Option	Sensor	Networkable	Scheduling	Occupancy	Daylight Harvesting	0-10V Dimming	On/off Control	Bluetooth® App Programming
NX Standalone								
NXS	NXSMP-SMI	No	Yes	Yes	Yes	Yes	Yes	Yes
NX Networked – Wired								
NXE	N/A	Yes	Yes	No	No	Yes	Yes	Requires NXBTC/R ¹
NXES	NXSMP-SMI	Yes	Yes	Yes	Yes	Yes	Yes	Yes
NX Networked – Wireless								
NXSW	NXSMP-SMI	Yes	Yes	Yes	Yes	Yes	Yes	Yes
NXWE	N/A	Yes	Yes	No	No	Yes	Yes	No ²

1 NXBTC/R needs to be plugged into an available NX SmartPORT™ on the fixture network
 2 To program NXWE option, need to consult factory. If connected to an area controller, programming can be done from that

Philips EasySense Controls ODPG Sensor:



- Occupancy sensing, daylight harvesting, task tuning and grouping in one device
- Standalone control or grouping to wireless switches¹
- Uses Philips field apps for on site commissioning^{2,3}
- Ability to create scenes for various room configurations
- Cost-effective solution for energy-savings and code-compliance strategies
- DLC® Qualified: Listed on the QPL for Networked Lighting Controls. Please refer to the DLC website for specific product qualifications at www.designlights.org

1 Wireless switches only compatible with ODPG Philips EasySense
 2 [See link to Philips commissioning](#)
 3 Requires android device or IR dongle. See links for [phone compatibility](#) and [IR dongle](#)

Wireless Switch Accessories¹

- [PESR-WH](#) EasySense compatible wireless single rocker switch, white
- [PEDR-WH](#) EasySense compatible wireless dual rocker switch, white



TCAT22

2' x 2' LED TWIN CONTEMPORARY ARCHITECTURAL TROFFER

DATE: _____ LOCATION: _____

TYPE: _____ PROJECT: _____

CATALOG #: _____

CONTROLS (CONTINUED)

SpectraSync™ Color Tuning Technology:

Control your space based on the needs of the application, specific activities throughout the day and preferences of the occupants with distinct SpectraSync™ Color Tuning Technologies.



SPECTRASYNC COLOR TUNING TECHNOLOGY		
Mode	Kelvin Range	Description
Tunable White	2700K–5000K 2700K–6500K	Offers users the ability to tailor CCT to their personal preference, enhancing task visibility, material and colors or the aesthetics of the space

SpectraSync Tunable White

Available in two options: 2750T (2700K–5000K) or 2765T (2700K–6500K). Requires two 0–10V controllers, one for intensity and one for CCT. Minimum 5% dimming.

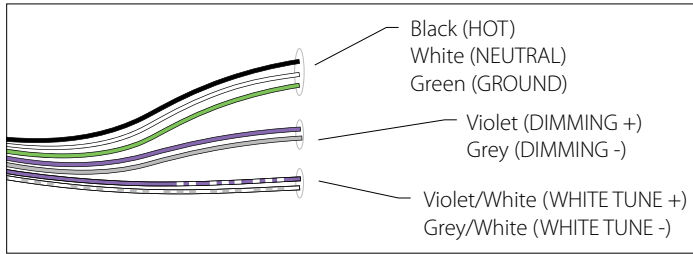

SpectraSync Tunable White luminaires are provided with two 0–10V circuits. The violet and grey circuit is for wiring to any qualified 0–10V controller for dimming. The violet/white and grey/white circuit is for wiring to any qualified 0–10V controller for Tunable White CCT control.

Controller Manufacturer Data

SpectraSync Tunable White was designed to be used with sinking style dimmers (provided by others) and is compatible with:

- Hubbell Control Solutions (HCS): NX Distributed Intelligence™ Room Controllers (NXRC) and In-fixture Controllers (NXFM)
- Lutron: DDTV, DVSTV, and NFTV dimmers
- Wattstopper: ADF120277 and CD4BL (Titan) dimmers

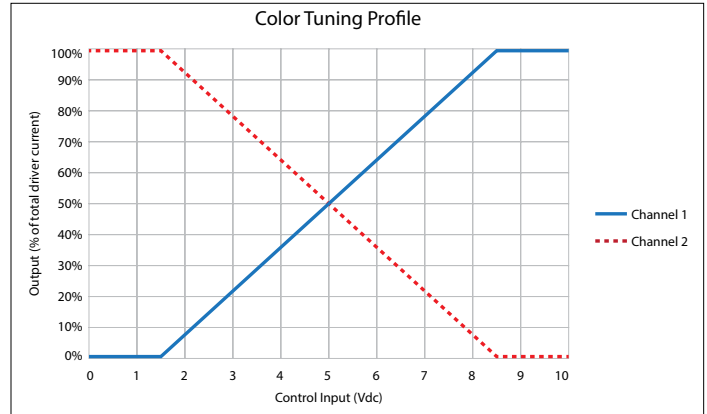

To enable scheduling and for use with NX wall control preset stations please refer to Hubbell Control Solutions NX SpectraSync technical sheet.

DELIVERED LUMENS, SPECTRASYNC™



Lumen Output	Watts	2700		3000		3500		4000		5000		6500	
		Lumens	LPW	Lumens	LPW	Lumens	LPW	Lumens	LPW	Lumens	LPW	Lumens	LPW
VW	12	1356	113	1417	118	1443	120	1461	122	1509	126	1486	124
MW	18	1986	110	2075	115	2112	117	2139	119	2210	123	2177	121
LW	22	2421	110	2530	115	2576	117	2608	119	2694	122	2654	121
ML	31	3230	104	3375	109	3436	111	3480	112	3594	116	3540	114
HL	30	3405	114	3558	119	3622	121	3668	122	3789	126	3732	124
VL	37	4129	112	4315	117	4393	119	4449	120	4595	124	4526	122

TCAT22

2' x 2' LED TWIN CONTEMPORARY ARCHITECTURAL TROFFER

DATE: _____ LOCATION: _____

TYPE: _____ PROJECT: _____

CATALOG #: _____

DELIVERED LUMENS

LUMEN PACKAGE	LUMENS	INPUT WATTS	LPW
TCAT22-30VWG	1417	12	118.1
TCAT22-35VWG	1460	12	121.7
TCAT22-40VWG	1483	12	123.6
TCAT22-50VWG	1517	12	126.4
TCAT22-30MWG	2075	18	115.3
TCAT22-35MWG	2138	18	118.8
TCAT22-40MWG	2177	18	120.9
TCAT22-50MWG	2364	18	131.3
TCAT22-30LWG	2530	22	115
TCAT22-35LWG	2606	22	118.5
TCAT22-40LWG	2646	22	120.3
TCAT22-50LWG	2882	22	131
TCAT22-30MLG	3375	31	108.9
TCAT22-35MLG	3476	31	112.1
TCAT22-40MLG	3530	31	113.9
TCAT22-50MLG	3844	31	124
TCAT22-30HLG	3558	30	118.6
TCAT22-35HLG	3665	30	122.2
TCAT22-40HLG	3722	30	124.1
TCAT22-50HLG	4053	30	135.1
TCAT22-30VLG	4315	37	116.6
TCAT22-35VLG	4445	37	120.1
TCAT22-40VLG	4514	37	122
TCAT22-50VLG	4620	37	124.9

TCAT22

2' x 2' LED TWIN CONTEMPORARY ARCHITECTURAL TROFFER

DATE: _____ LOCATION: _____

TYPE: _____ PROJECT: _____

CATALOG #: _____

DIMENSIONS

GRID

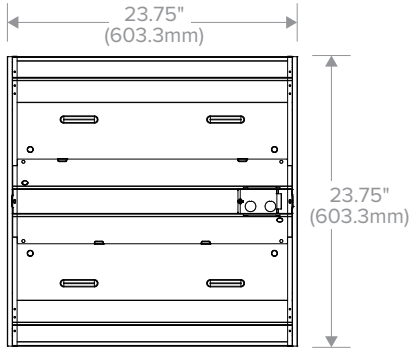

Grid, back of housing

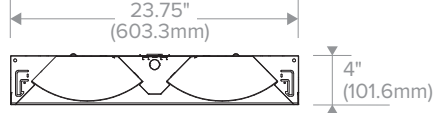

Grid, recessed section

CEILING COMPATIBILITY

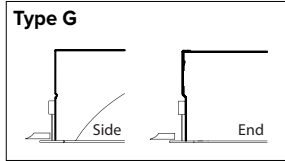

For lay-in installation in exposed grid ceilings. Maximum tee widths of 1" and maximum tee heights of 2" allowed.

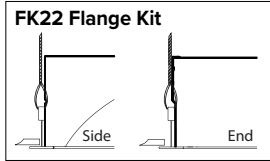

For hard ceiling applications, order FK22 flange kit. Flange kit wires directly into concealed ceiling opening for a clean, finished appearance.

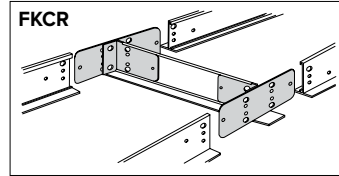

For flanged fixtures in row configurations, the FKCR adapter bracket kit is required in addition to the FK22 kit. Order one less FKCR than the total number of fixtures in row. (Example: Row of two, order (2) FK22 & (1) FKCR)

Row cut out dimensions using FK22s & FKCR adapters:
Width 24³/₈", Length [24" x (# in row)] + ³/₈".
Example: [24" x 2] + ³/₈" = 48³/₈"

Flange kit cut out dimension for single unit only: 24³/₈" x 24³/₈"

SURFACE MOUNT OR CABLE MOUNT

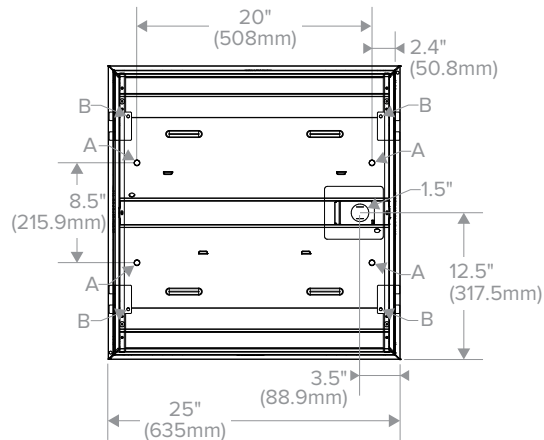

Surface section (SM)

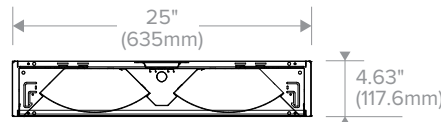

Surface Mount (SM) and Cable Mount (CM), back of housing

Surface Mount:
Order SM ceiling type. Mounting collar required for surface mounting. (4) Mounting knock-outs, ⁵/₈", provided in center channel as indicated at left, marked A.

Cable Mount:
Order CM ceiling type. Use CM48Y2SC3F-KIT 48" Cable Mount Kit for 2' wide CM trim fixtures. Mounting holes are provided in diagonal straps shown at left, marked B.

* For Cable Mount a 2' x 3' access plate with (4) ⁷/₈" KOs provided in place of Mounting Collar shown.

NOTE: Dimensions and specifications are subject to change without notice. Please consult factory or check sample for verification.

TCAT22

2' x 2' LED TWIN CONTEMPORARY ARCHITECTURAL TROFFER

PHOTOMETRY

TCAT22-35LWX-EDU

LUMINAIRE DATA

Test No.	16556
Description	2' x 2' LED recessed architectural troffer with acrylic refractor
Delivered Lumens	2606
Watts	21.60
Efficacy	121
Mounting	Recessed
Spacing Criterion	0° = 1.17 90° = 1.26

ZONAL LUMEN SUMMARY

Zone	Lumens	% Luminaire
0-30	760	29.2
0-40	1232	47.3
0-60	2110	80.9
0-90	2606	100
0-180	2606	100

POLAR GRAPH

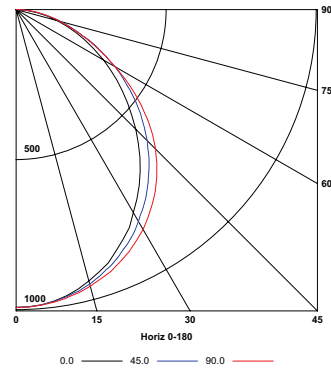

TCAT22-35MLX-EDU

LUMINAIRE DATA

Test No.	16573
Description	2' x 2' LED recessed architectural troffer with acrylic refractor
Delivered Lumens	3476
Watts	30.80
Efficacy	113
Mounting	Recessed
Spacing Criterion	0° = 1.18 90° = 1.26

ZONAL LUMEN SUMMARY

Zone	Lumens	% Luminaire
0-30	1013	29.1
0-40	1642	47.2
0-60	2812	80.9
0-90	3476	100
0-180	3476	100

POLAR GRAPH

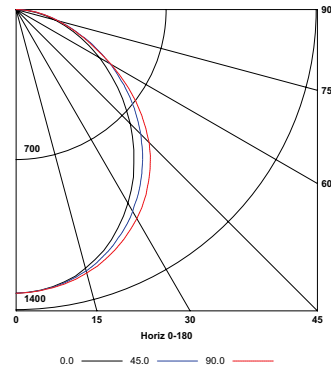

TCAT22-35HLX-EDU

LUMINAIRE DATA

Test No.	16576
Description	2' x 2' LED recessed architectural troffer with acrylic refractor
Delivered Lumens	3665
Watts	29.90
Efficacy	123
Mounting	Recessed
Spacing Criterion	0° = 1.18 90° = 1.26

ZONAL LUMEN SUMMARY

Zone	Lumens	% Luminaire
0-30	1066	29.1
0-40	1728	47.1
0-60	2962	80.8
0-90	3665	100
0-180	3665	100

POLAR GRAPH

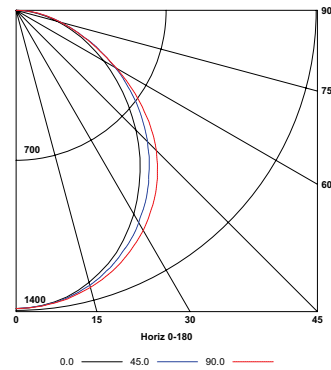

ADDITIONAL INFORMATION

DTS WIRING DIAGRAM (0-10V DIMMING DRIVER SHOWN)

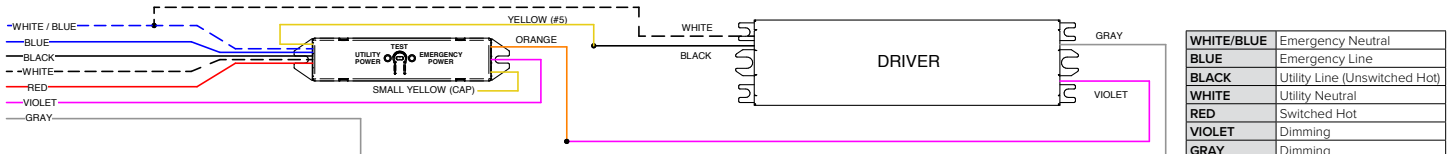

All product and company names, logos and product identifiers are trademarks™ or registered trademarks® of Hubbell Lighting, Inc. or their respective owners. Use of them does not necessarily imply any affiliation with or endorsement by such respective owners.