

LTRX22

2' x 2' Ambient/Exam Enclosed Luminaire

LTRX is designed for medical examination rooms and provides a normal, comfortable general ambient light level as standard. When switched to exam mode, LTRX doubles the light level on the examination table. A curved, easily cleaned surface, LTRX ships standard with antimicrobial paint which resists bacterial growth on exposed painted surfaces.

Catalog Number	
Comments	Type



FEATURES

- Designed specifically to provide comfortable ambient lighting or high lumen levels for examinations on demand
- Step dimming LED drivers provide ability to go from ambient to exam light levels
- Standard high performance matte white antimicrobial paint resists bacterial growth on exposed painted surfaces
- 90 CRI standard with a high R9 for excellent color rendering
- Enclosed lens protects against intrusion of contaminants
- High efficiency lens features linear prism acrylic for visual comfort and high performance without LED pixelation
- Long life, 50,000 hour LEDs at L80 reduce life cycle maintenance costs
- Lens gasket option and wet location listing available
- Low W/ft² ratio typically meets most restrictive lighting power density codes
- Electrical components accessible from below the ceiling with modular replaceability
- QR code for future traceability
- DLC® (DesignLights Consortium) Qualified - see www.designlights.org



SPECIFICATIONS

Construction: Luminaire housing and end caps are die formed code gauge cold rolled steel. Reflector is stiffened with linear forms, profiled to a precision curve. High transmission extruded acrylic enclosed lens features linear prisms and custom frost for high efficacy without pixelation.

Shielding: Thermoplastic light seals snap into the housing at both ends of the lens to prevent light leaks. Lens hinges down for easy access to LED module and electrical components. Optional gasketing available to surround the lamp cavity (standard when Wet Label option is ordered).

Finish: Supplied standard with antimicrobial paint; resists bacterial growth on exposed painted surfaces. Paint is custom formulated high reflectivity matte white for uniform indirect illumination and attractive, professional appearance.

Installation/Mounting: For recessed products (G) an access plate is furnished with each luminaire for fast wiring access without the necessity to open the fixture or wireway. Surface mount (SM) products are provided with a surface mounting collar.

Ceiling Compatibility: Luminaire fits recessed exposed Grid ceilings (G); four integral NEC compliant T-bar clips are standard. Can be placed in Slot Grid (SG) style ceiling with regress 3/8" above ceiling plane. A Flange Kit (FK) accessory is available for recessed hard ceiling applications. Surface Mount (SM) option allows placement below ceiling plane.

Certification: All luminaires are built to UL1598 and 2108 standards, and bear appropriate CSA labels. Damp location label standard. IC Label standard. Wet location listing available on all configurations. Emergency-equipped fixtures labeled UL 924 and Dry Location unless specified. Adheres to LM79, LM80, and TM21 industry standards. DLC® (DesignLights Consortium) Qualified. Please refer to the DLC website for specific product qualifications at www.designlights.org.

Warranty: Five year warranty (Terms and Conditions apply).

ORDERING GUIDE

EXAMPLE: LTRX22-35AXG-RFA-EAXU

LTRX		22 -		AX		- RFA -		EAX		U -	
MODEL	SIZE	COLOR TEMP	LUMEN OUTPUT	CEILING TYPE	SHIELDING	DRIVER	VOLTAGE	OPTIONS			
LTRX Ambient / Exam Enclosed Luminaire	22' 2' x 2'	30 3000K 35 3500K 40 4000K	AX Ambient / Exam	G Grid Lay-In ¹ SM Surface Mount CM Cable/Suspended Mount ²	RFA Ribbed Frosted Acrylic	EAX Ambient/ Exam	U 120V-277V	ELL14 Emergency Battery Pack Installed, 1400 Lumens ^{3,4} C488 4-Wire Flex GLR Fast Blow Fuse G1 Lens Gasketing WL Wet Location4 CP Chicago Plenum			
ACCESSORIES (ORDER SEPARATELY)			PRODUCT AVAILABILITY								
FK22	2' x 2' Single Flange Kit (Shipped separately)		SIZE	OUTPUT	LIGHT LEVEL	LUMENS	WATTS	LUMENS PER WATT			
			22	AX	Ambient	1450-1675	17	95-98			
			22	AX	Exam	3650-4175	40	91-104			

¹ For drywall order FK22 accessories separately.

² Order hanger accessories separately.

³ For compatibility with Dual-Lite LiteGear® inverters in lieu of installed battery pack, contact Hubbell Lighting Representative.

⁴ Wet Location not available with battery packs.

LTRX22

2' x 2' Ambient/Exam Enclosed Luminaire

PHOTOMETRY

LUMINAIRE DATA - AMBIENT MODE

Luminaire	LTRX22-40AXG-RFA-EAXU LTRX LED Transition Exam Light, Recessed Architectural 2 x 2 LED with frosted linear prism lens
Ballast	XI054C150V054SNT1
Ballast Factor	1.00
Lamp	LED
Fixture Lumens	1674
Watts	17.00
Mounting	Recessed
Shielding Angle	0° = 90 90° = 90
Spacing Criterion	0° = 1.18 90° = 1.32
Luminous Opening in Feet	Length: 1.92 Width: 1.92 Height: 0.00

ZONAL LUMEN SUMMARY

Zone	Lumens	% Lamp	% Fixt.
0-30	435	26	26
0-40	711	42.5	42.5
0-60	1269	75.8	75.8
0-90	1674	100.0	100.0
0-180	1674	100.0	100.0

ENERGY DATA

Total Luminaire Efficiency	100.0%
Total Lumens per Watt	98
IESNA RP-1-1993 Compliance	Non-Compliant
Comparative Yearly Lighting Energy Cost per 1000 Lumens	\$2.45 based on 3000 hrs. and \$0.08 per KWH

TEST #15832 TEST DATE 2/16/2016

INDOOR CANDELA PLOT



LUMINAIRE DATA - EXAM MODE

Luminaire	LTRX22-40AXG-RFA-EAXU LTRX LED Transition Exam Light, Recessed Architectural 2 x 2 LED with frosted linear prism lens
Ballast	XI054C150V054SNT1
Ballast Factor	1.00
Lamp	LED
Fixture Lumens	4185
Watts	40.20
Mounting	Recessed
Shielding Angle	0° = 90 90° = 90
Spacing Criterion	0° = 1.18 90° = 1.32
Luminous Opening in Feet	Length: 1.92 Width: 1.92 Height: 0.00

ZONAL LUMEN SUMMARY

Zone	Lumens	% Lamp	% Fixt.
0-30	1087	26.0	26.0
0-40	1779	42.5	42.5
0-60	3172	75.8	75.8
0-90	4185	100.0	100.0
0-180	4185	100.0	100.0

ENERGY DATA

Total Luminaire Efficiency	100.0%
Total Lumens per Watt	104
IESNA RP-1-1993 Compliance	Non-Compliant
Comparative Yearly Lighting Energy Cost per 1000 Lumens	\$2.29 based on 3000 hrs. and \$0.08 per KWH

TEST #16.00314 TEST DATE 2/16/2016

INDOOR CANDELA PLOT

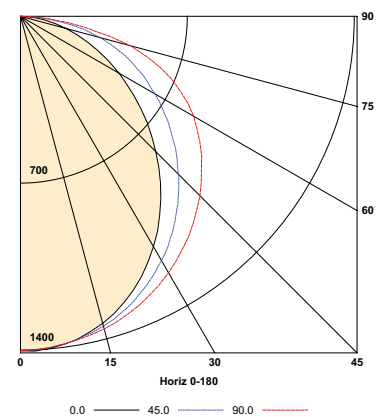

LTRX22

2' x 2' Ambient/Exam Enclosed Luminaire

DIMENSIONAL DATA – GRID

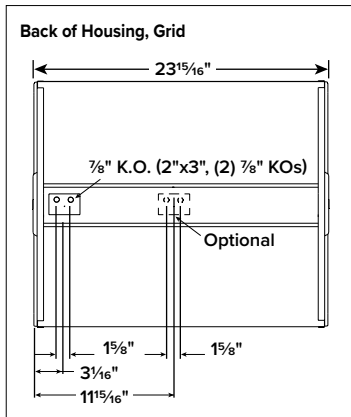
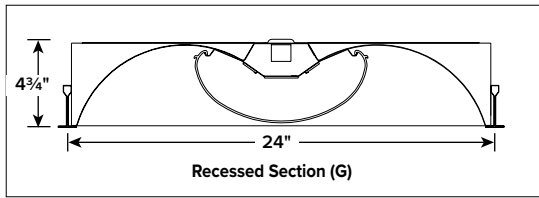

CEILING COMPATIBILITY

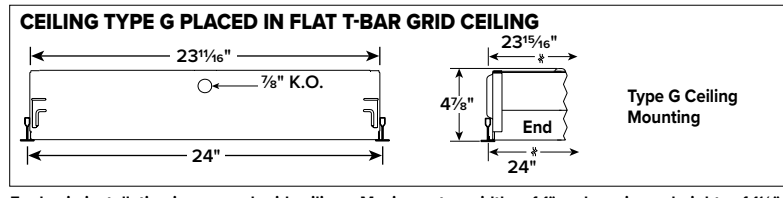

For lay-in installation in exposed grid ceilings. Maximum tee widths of 1" and maximum heights of 1 1/2" allowed.

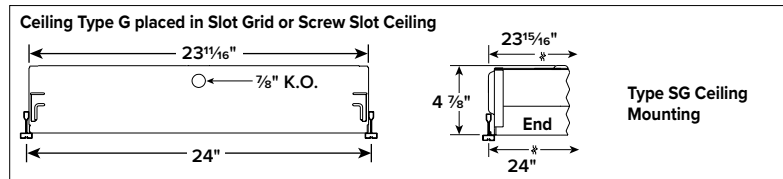

For 3/8" slot grid type ceilings. Luminaire will be regressed 3/8" above horizontal surface of the tee.

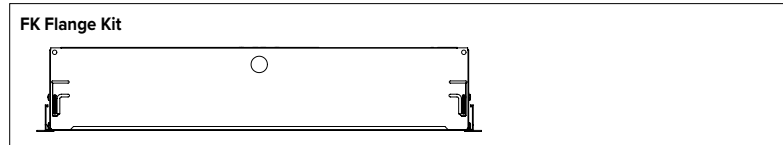

For hard ceiling applications, fixtures must be ordered with a flange kit that wires directly into the concealed ceiling opening for a clean finished appearance. For row configurations contact your local Columbia Representative.

Flange kit cut out dimension for single FK22: 24 3/8" x 24 3/8"

DIMENSIONAL DATA – SURFACE MOUNT & CABLE MOUNT

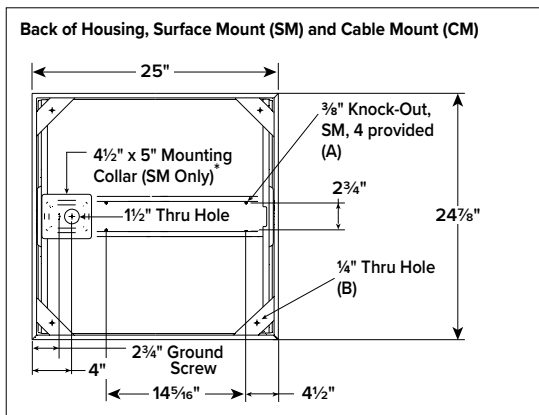
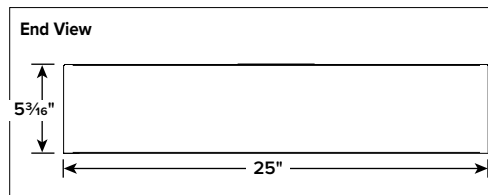
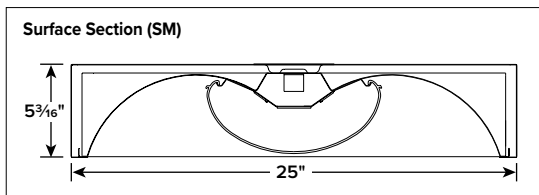

Surface Mount:
Order SM ceiling type. Mounting collar required for surface mounting. (4) Mounting knock-outs, 3/8", provided in center channel as indicated at left, marked (A).

Cable Mount:
Order CM ceiling type. Use CM48Y2SC3F-KIT 48" Cable Mount Kit for 2' wide CM fixtures. Mounting holes are provided in diagonal straps shown at left, marked (B).

* For Cable Mount a 2" x 3" access plate with (4) 7/8" KO's provided in place of Mounting Collar shown.

NOTE: All dimensions are in inches; dimensions and specifications are subject to change without notice. Please consult factory or check sample for verification.