

PHBH SERIES



HUBBELL
Industrial Lighting

THE PERFORMANCE HAZARDOUS LOCATION HIGH BAY

CAT.#	APPROVALS
JOB	TYPE

SPECIFICATIONS

Applications -

The PHBH is a Class I, Division 2 high bay made for tough industrial locations. It is an IP66 rated housing made of low copper alloy die cast aluminum. A choice of four optics and three lumen levels allows the PHBH to be configured to your unique lighting application.

Construction -

- Three piece low copper alloy die cast aluminum housing
- Easy one person installation on threaded conduit (¾" or 1")
- 60,000 hour LEDs at L80 (up to 86,000 projected life) for reduced maintenance
- Lifetime hours based on TM21-11 calculations
- Ambient temperature range is from -40°C to 65°C
- Weight: 30 lbs.

Performance -

- Up to 28,000 lumens
- 141 LPW (lumens/watt)

Shielding (Five Lens Options) -

- High transmissive flat acrylic
- Translucent sag polycarbonate
- Prismatic drop acrylic lens
- Conical drop acrylic lens
- Flat clear glass lens

Electrical -

- Total input wattage of 216W, 156W or 103W
- Replacement for 400W PSMH / 250W PSMH or 175W PSMH
- Standard unit is continuously dimmable (0-10V control)
- Mid power LEDs for high LPW and low glare
- Universal voltage of 120VAC - 277VAC / 50/60 Hz
- 347 VAC / 480 VAC 50/60 Hz (Not available on ML - 16,000 Lumen versions)

Certification -

- Tested and qualified to UL844, Class I, Division 2, Groups A, B, C and D



- T Code T5
- Built to UL 1598 standard and certified by CSA
- Wet Location Listed
- IP66 Rated

Warranty -

- Five years warranty (Terms and Conditions apply)



ORDERING INFORMATION

ORDERING EXAMPLE: PHBH-5K-LV-P95-U-A-2-WH

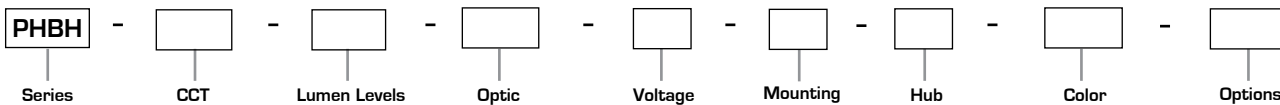

SERIES

PHBH The Performance High Bay

SPC Sag Polycarbonate

P95 Acrylic P95

FGL Flat Glass Lens

MOUNTING

A Pendant

B Well Bracket

C Cone

D Stanchion 25°

N None

COLOR

WH White

GR Gray

TN Tan

CCT

3K 3000K, 80 CRI

4K 4000K, 80 CRI

5K 5000K, 80 CRI

VOLTAGE

U Universal

1 120

2 208

3 240

4 277

F 347

5 480

HUB

2 ¾" (Mounts A, B and C)

3 1" (Mounts A, B and C)

4 1¼" (Mount D only)

5 1½" (Mount D only)

OPTIONS

F(x) Fusing

Notes: Replace [X] with the voltage, 1=120V, 2=208V, 3=240V, 4=277V, F=347V and 5=480V

LUMEN LEVELS

LV 14,000 lumens

ML 20,000 lumens

MM 28,000 lumens

OPTIC

CDL Prismatic Conical Drop Acrylic

DLR Prismatic Drop Acrylic

LENS OPTIONS

	LPW	SC	MATERIAL	SHAPE	FEATURE
P95	141	1.22	Clear Acrylic	Flat with a slight haze	Highest LPW
CDL	134	1.11	Clear Acrylic	Conical Ribs	Low Profile
DLR	133	1.28	Clear Acrylic	Dropped Refractor	Good Glare control, widest distribution
SPC	131	1.22	Milk White Acrylic	Smooth Sag Lens	Best glare control

LENS OPTIONS

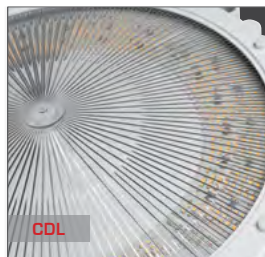

ELECTRICAL DATA

CCT	LUMENS	LENS	CATALOG STRING	LUMEN OUTPUT	WATTS	LUMINAIRE EFFICACY	AMBIENT TEMP. RATING	SPACING RATIO	120V	208V	240V	277V	347V	480V
3K	LV	CDL	PHBH-3K-LV-CDL-U-XX-XX	12785	103	124	65°C	1.1	0.87	0.5	0.43	0.38	0.3	0.22
		DLR	PHBH-3K-LV-DLR-U-XX-XX	12713		123		1.3						
		SPC	PHBH-3K-LV-SPC-U-XX-XX	12538		122		1.2						
		FGL	PHBH-3K-LV-FGL-U-XX-XX	14166		137		1.2						
		P95	PHBH-3K-LV-P95-U-XX-XX	13518		131		1.2						
	ML	CDL	PHBH-3K-ML-CDL-U-XX-XX	18695	156	126	65°C	1.1	1.33	0.76	0.66	0.51	-	-
		DLR	PHBH-3K-ML-DLR-U-XX-XX	17811		120		1.3						
		SPC	PHBH-3K-ML-SPC-U-XX-XX	18179		122		1.2						
		FGL	PHBH-3K-ML-FGL-U-XX-XX	20478		130		1.2						
		P95	PHBH-3K-ML-P95-U-XX-XX	19604		132		1.2						
	MM	CDL	PHBH-3K-MM-CDL-U-XX-XX	24492	216	113	60°C	1.1	1.85	1.05	0.91	0.79	0.63	0.47
		DLR	PHBH-3K-MM-DLR-U-XX-XX	24129		112		1.3						
		SPC	PHBH-3K-MM-SPC-U-XX-XX	23855		110		1.2						
		FGL	PHBH-3K-MM-FGL-U-XX-XX	26609		122		1.2						
		P95	PHBH-3K-MM-P95-U-XX-XX	25736		119		1.2						
4K	LV	CDL	PHBH-4K-LV-CDL-U-XX-XX	13416	103	130	65°C	1.1	0.87	0.5	0.43	0.38	0.3	0.22
		DLR	PHBH-4K-LV-DLR-U-XX-XX	13340		130		1.3						
		SPC	PHBH-4K-LV-SPC-U-XX-XX	13156		128		1.2						
		FGL	PHBH-4K-LV-FGL-U-XX-XX	14865		143		1.2						
		P95	PHBH-4K-LV-P95-U-XX-XX	14185		138		1.2						
	ML	CDL	PHBH-4K-ML-CDL-U-XX-XX	19617	156	126	65°C	1.1	1.33	0.76	0.66	0.51	-	-
		DLR	PHBH-4K-ML-DLR-U-XX-XX	18689		120		1.3						
		SPC	PHBH-4K-ML-SPC-U-XX-XX	19076		122		1.2						
		FGL	PHBH-4K-ML-FGL-U-XX-XX	21488		137		1.2						
		P95	PHBH-4K-ML-P95-U-XX-XX	20571		132		1.2						
	MM	CDL	PHBH-4K-MM-CDL-U-XX-XX	25700	216	119	60°C	1.1	1.85	1.05	0.91	0.79	0.63	0.47
		DLR	PHBH-4K-MM-DLR-U-XX-XX	25319		117		1.3						
		SPC	PHBH-4K-MM-SPC-U-XX-XX	25031		116		1.2						
		FGL	PHBH-4K-MM-FGL-U-XX-XX	27648		128		1.2						
		P95	PHBH-4K-MM-P95-U-XX-XX	27005		125		1.2						
5K	LV	CDL	PHBH-5K-LV-CDL-U-XX-XX	13778	103	134	65°C	1.1	0.87	0.5	0.43	0.38	0.3	0.22
		DLR	PHBH-5K-LV-DLR-U-XX-XX	13700		133		1.3						
		SPC	PHBH-5K-LV-SPC-U-XX-XX	13511		131		1.2						
		FGL	PHBH-5K-LV-FGL-U-XX-XX	15266		147		1.2						
		P95	PHBH-5K-LV-P95-U-XX-XX	14568		141		1.2						
	ML	CDL	PHBH-5K-ML-CDL-U-XX-XX	20147	156	126	65°C	1.1	1.33	0.76	0.66	0.51	-	-
		DLR	PHBH-5K-ML-DLR-U-XX-XX	19194		120		1.3						
		SPC	PHBH-5K-ML-SPC-U-XX-XX	19591		122		1.2						
		FGL	PHBH-5K-ML-FGL-U-XX-XX	22068		137		1.2						
		P95	PHBH-5K-ML-P95-U-XX-XX	21126		132		1.2						
	MM	CDL	PHBH-5K-MM-CDL-U-XX-XX	26394	216	122	60°C	1.1	1.85	1.05	0.91	0.79	0.63	0.47
		DLR	PHBH-5K-MM-DLR-U-XX-XX	26003		120		1.3						
		SPC	PHBH-5K-MM-SPC-U-XX-XX	25707		119		1.2						
		FGL	PHBH-5K-MM-FGL-U-XX-XX	27921		128		1.2						
		P95	PHBH-5K-MM-P95-U-XX-XX	27734		128		1.2						

PHOTOMETRIC DATA: IES_PHBH_4K_MM_P95 | 17.00393

LUMINAIRE DATA

PHBH-4K-MM-P95

Luminaire - The Performance High Bay with P95 Acrylic Flat Lens

DRIVER LEDINTA0024V41DLO

Driver Factor	1.00
Lamp	LED
Lumens	27,005
Watts	215.8
Efficacy	125.1
Mounting	Pendant
Spacing Criterion [0-180]	1.23

LUMINOUS OPENING IN FEET

Length	1.50 ft. (Diameter)
Width	1.25 ft. (Diameter)

ZONE	LUMENS	% FIXT.
0-30	8,011	29.7
0-40	12,978	48.1
0-60	22,073	81.7
0-90	27,004	100.0b
0-180	27,005	100.0

ISOMETRIC FOOT CANDLES

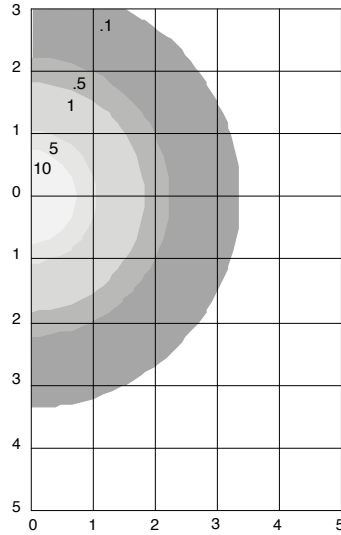

POLAR GRAPH

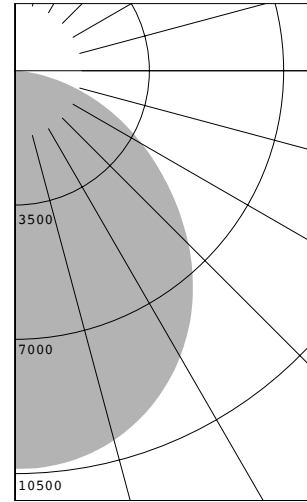

PHOTOMETRIC DATA: IES_PHBH_4K_LV_P95 | 17.00411

LUMINAIRE DATA

PHBH-4K-LV-P95

Luminaire - The Performance High Bay with SPC sag polycarbonate lens

DRIVER LEDINTA0024V41DLO

Driver Factor	1.00
Lamp	LED
Lumens	14,185
Watts	103.0
Efficacy	137.7
Mounting	Pendant
Spacing Criterion [0-180]	1.23

LUMINOUS OPENING IN FEET

Length	1.50 ft. (Diameter)
Width	1.25 ft. (Diameter)

ZONE	LUMENS	% FIXT.
0-30	4,235	29.9
0-40	6,853	48.3
0-60	11,630	82.0
0-90	14,185	100.0
0-180	14,185	100.0

ISOMETRIC FOOT CANDLES

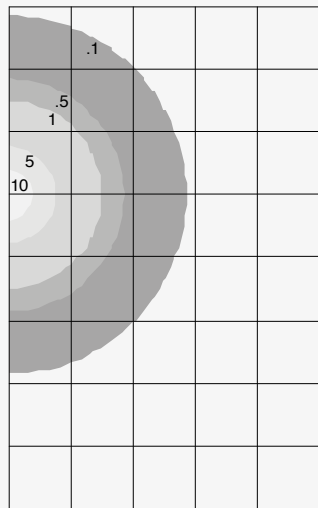

POLAR GRAPH

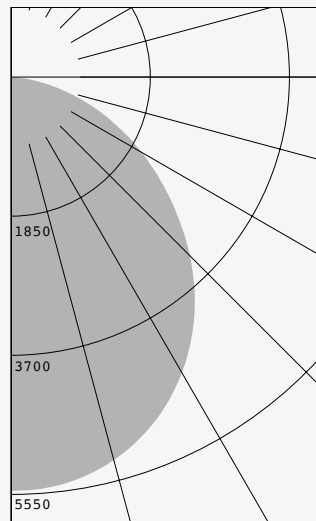

DIMENSIONS

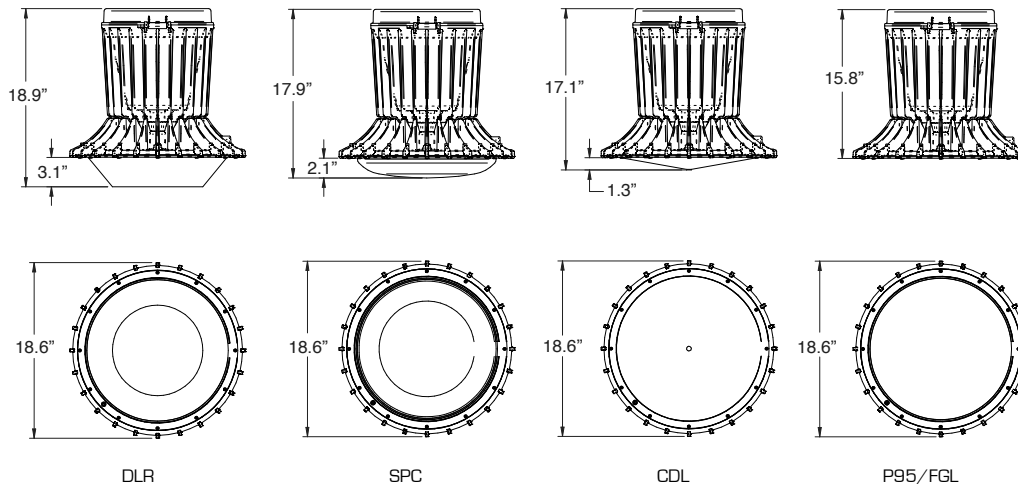

Due to our continued efforts to improve our products, specifications are subject to change without notice.
© 2018 Hubbell Lighting All Rights Reserved.

For more information visit our web site: <http://www.hubbellindustrial.com/>
Phone: 1-864-678-1000