

JOB _____ TYPE _____

NOTES _____ APPROVALS _____

FEATURES

- Full Cutoff PicoEmitter technology
- Available in 580nm, 3000K, 4000K and 5000K standard CCT
- Type 1, 2, 3, 4, 5, R & L distributions
- 0-10V dimming drivers standard
- Sealed optical chamber, IP66 certified

Certifications



SPECIFICATIONS

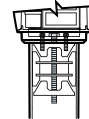
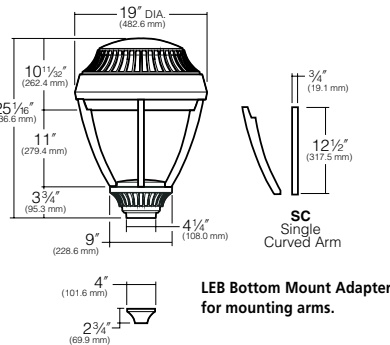

Flush Mount
slips into a 3.375" Ø - 5" Ø open top pole or tenon with up to .25" profile thickness

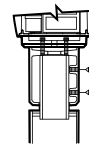

Post Top
slips over a 2 3/8" Ø pole or tenon with 4" of engagement

Approx. Weight = 54 lbs. EPA 1.0 for FM.
See Configuration for Additional EPAs.

ORDERING CODE

Configuration	EPA	Fixture	Electrical Module	Fixture Finish	Photocell Options
<ul style="list-style-type: none"> • FM Flush Mount • PT Pipe Tenon Mt. • 1SA 1 Arm Side Mt. • 2SB 2 Arm Side Mt. • 3SY 3 Arm Side Mt. • 4SC 4 Arm Side Mt. • 1W Single Wall Mt. 	1.0 1.0 0.7 1.4 2.1 2.4 n/a	LEB19SC Lantern, Era Bottom Mnt. 19" Single Curved Arm Distribution: 1 Type I, 2 Type II, 3 Type III, 4 Type IV, 5 Type V R Type R Right, L Type L Left	E35 350mA PicoEmitter 60L 60 LEDs, 67W Source: 2K 580nm ² , 3K 3000K, 4K 4000K, 5K 5000K Color Temperature ¹ Voltages: 120 120V, 208 208V, 240 240V, 277 277V, 347 ³ 347V, 480 ³ 480V	BL Black DB Dark Bronze GT Graphite LG Light Gray PS Platinum Silver TT Titanium WH White CC Custom Color*	A25-7 7-pin Photocell Receptacle A30 120V Button Photocell A31 208V Button Photocell A32 240V Button Photocell A33 277V Button Photocell A34 480V Button Photocell A35 347V Button Photocell

NOTE: EPA is for Fixture only

*Consult Representative

Fuse Options	NFO Option	Control Options	Arm Options	Mounting Options
SF 120, 277, 347 Line Volts DF 208, 240, 480 Line Volts	NFO Neighbor Friendly Optic. Photometry available for Type III/IV. All others, consult factory.	<u>Wireless</u> WIR-RMI-IO 120-480V, 1000' range, wiS-CAPE RF control system with on/off/dim, alerts, monitoring and metering capabilities <u>Motion</u> SCL-R Round Pole Mounted Occupancy Sensor up to 16' SCL-S Square Pole Mounted Occupancy Sensor up to 16' SCH-R Round Pole Mounted Occupancy Sensor 16' to 30' SCH-S Square Pole Mounted Occupancy Sensor 16' to 30'	Pole Arm HA11S HA11S-TM1, HA11S-TM2, HA11S-TM3, HA11S-TM4 HA12S HA12S-TM1, HA12S-TM2, HA12S-TM3, HA12S-TM4 HA14S HA14S-TM1, HA14S-TM2, HA14S-TM3, HA14S-TM4 HA31S HA31S-TM1, HA31S-TM2, HA31S-TM3, HA31S-TM4 HA33S HA33S-TM1, HA33S-TM2, HA33S-TM3, HA33S-TM4 HA37S HA37S-TM1 HA38S HA38S-TM1	Wall Mount HA11S-W Side Pole Swept Cast Arm HA12S-W Side Pole S-Shaped Up Cast Arm HA14S-W Side Pole Neo-Classic Arm HA31S-W Side Pole Arm w/ Top Scroll HA33S-W Side Pole Ribbon Arm w/Top Gusset HA37S-W Side Pole Ribbon w/ Top Brace, Bottom Scroll HA38S-W Side Pole Ribbon w/ Top Brace, Bottom Gusset

For Pole Spec Select: http://www.kimlighting.com/products/arms_and_poles/
 For Control Spec Select: <http://trpsl.com/index.html>

¹ For custom optics and color temperature configurations, contact factory.
² Turtle friendly. Maximum 500mA drive current for 2K amber option.
³ 347V & 480V currents may be supplied with step-down transformer.

Kim Lighting reserves the right to change specifications without notice.

ARM OPTIONS

Note: Refer to Kim Lighting's Arms and Poles Specification Guide for EPA information and additional information on arm, tenon and wall mounting.

1W Wall Mount arm is not included and must be ordered separately.

Side Pole Swept Cast Arm

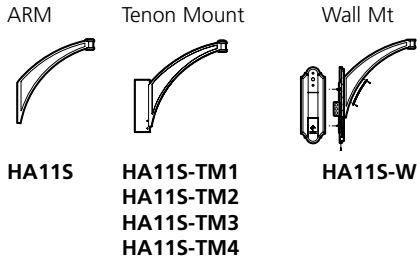

Mounting: 1A 2B 3Y 4C

Side Pole S-Shaped Up Cast Arm

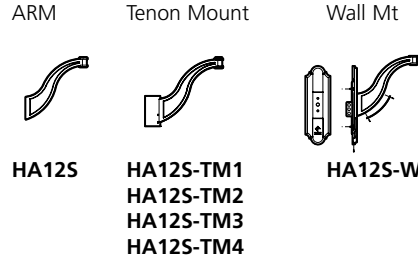

Mounting: 1A 2B 3Y 4C

Side Pole S-Shaped Down Cast Arm

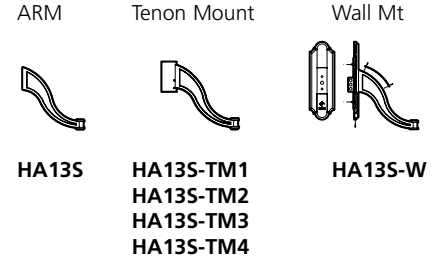

Mounting: 1A 2B 3Y 4C

Side Pole/Wall Mount Ribbon Arm w/Bottom Scroll

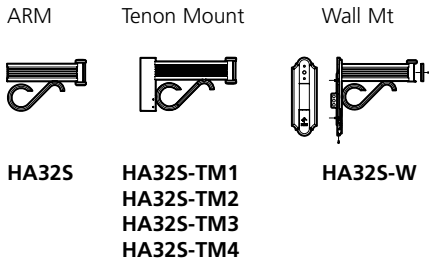

Mounting: 1A 2B 3Y 4C

Side Pole/Wall Mount Ribbon Arm w/Bottom Gusset

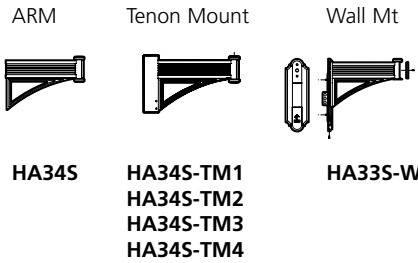

Mounting: 1A 2B 3Y 4C

Side Pole Ribbon Arm w/Bottom Brace

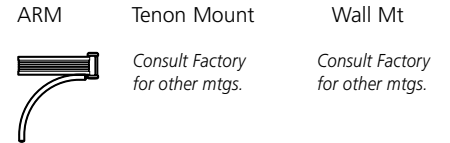

Mounting: 1A

Arm Finial

HAF02 Traditional style finial available to close off mounting hub opposite fixture.



Finial

TF Heavy cast aluminum finial on top of lantern housing. For use with Bottom Mount (BM) luminaire only.

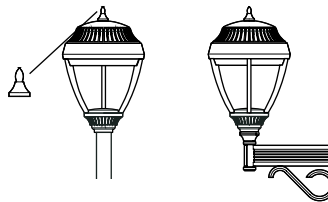

Kim Lighting reserves the right to change specifications without notice.

LUMINAIRE PERFORMANCE

Spectroradiometric			
	3000K Average	4000K Average	5000K Average
Color Rendering Index (CRI)	≤80	≤80	≤70
Power Factor	>.90	>.90	>.90

Projected Lumen Maintenance		
mA	100,000 hrs	(Calculated L70)
350 mA	93.33%	596,000 hrs.

Electrical Drive Current		
Volts - AC	Amps - AC	System Watts
120	0.56	67
208	0.32	67
240	0.28	67
277	0.24	67
347	0.19	67
480	0.14	67

B.U.G. Rating (TM15) in Lumens wher B = Backlight, U = Uplight, G = Glare								
Temperature	TYPE 1	TYPE 2	TYPE 3	TYPE 3 NFO	TYPE 4	TYPE 4 NFO	TYPE 5	TYPE L/R
3000K	TBD	B1 U0 G1	B1 U0 G1	N/A	B1 U0 G1	B0 U0 G1	B2 U0 G1	TBD
4000K	TBD	B2 U0 G2	B1 U0 G1	N/A	B1 U0 G1	B1 U0 G1	B2 U0 G1	TBD
5000K	TBD	B2 U0 G2	B1 U0 G1	N/A	B1 U0 G1	B1 U0 G1	B3 U0 G1	TBD

Absolute Lumens								
Temperature	TYPE 1	TYPE 2	TYPE 3	TYPE 3 NFO	TYPE 4	TYPE 4 NFO	TYPE 5	TYPE L/R
3000K	TBD	3714	3522	N/A	3507	2951	3685	TBD
4000K	TBD	4822	4573	N/A	4553	3830	4784	TBD
5000K	TBD	5159	4892	N/A	4871	4098	5118	TBD

LED performance and lumen output continues to improve at a rapid pace. Log onto www.kimlighting.com to download the most current photometric files from Kim Lighting's IES File Library. For custom optics and color temperature configurations, contact factory.
 *Data is prorated from 5000K IES files.

Kim Lighting reserves the right to change specifications without notice.

SPECIFICATIONS
Housing:

- One-piece die-cast, low copper (<0.6% Cu) aluminum alloy with integral cooling ribs over the optical chamber and electrical compartment.
- Solid barrier wall separates optical and electrical compartments.
- Double-thick wall with gussets on the support-arm mounting end.
- Housing forms a half cylinder with 55° front face plane providing a recess to allow a flush single-latch detail.
- All hardware is stainless steel or electro-zinc plated steel.

Lens Frame:

- One-piece die-cast, low copper (<0.6% Cu) aluminum alloy lens frame with 1" minimum depth around the gasket flange.
- Integral hinges with stainless steel pins provide no-tool mounting and removal from housing.
- Single die-cast aluminum cam-latch provides positive locking and sealing of the optical chamber by a one-piece extruded and vulcanized silicone gasket to provide an IP66 rating for the optical module.
- Clear 3/8" thick tempered glass lens retained by eight steel clips with full silicone gasketing around the perimeter.

Neighbor Friendly Optic

- Integrated Neighbor Friendly Optic on each PicoEmitter module to completely control unwanted backlight. Most effective with Type III and IV distributions.

Lens:

- One-piece clear tempered glass lens sealed with silicone gasket.

Optical Module:

- Precision, replaceable PicoEmitters are positioned to achieve directional control toward desired task.
- The entire EmitterDeck fastens to the housing as a one-piece module.
- Type I, II, III, IV, V, L (left), and R (right) standard distributions. Custom available.
- 3000K, 4000K, 5000K standard CCT. Amber and custom available.
- IP66 certified
- Die-cast, low copper aluminum heat sink

modules provide thermal transfer at PCB level.

- Anodized aluminum carrier plate and heat sink modules.

Electrical Characteristics:

- 120V through 480V @ 50/60Hz.
- Class 1, 350mA.
- Power Factor = >.90
- National Electrical Code, ANSI/NFPA 70.
- 10kV surge suppression.
- Thermalshield thermal control.
- -40c starting driver.
- 0-10V dimming interface.
- All electronic components are IP66 rated.
- Electronic components are UL and/or CSA recognized.

Dimming:

- 10% to 100% dimming using standard 0-10V interface driver.
- To activate the dimming system, a wiring harness is supplied and attached to the DIM Port (DIM IN) on the thermal shield protection system. This port allows the 0-10V Interface to bypass the thermal shield and control the driver.
- The thermal shield works in conjunction with the control system to assure that overheating will not harm the LEDs.

The wiring harness is connected with the use of the Purple lead as the positive (+) and the Grey lead as the negative (-) to an available control signal (by others).

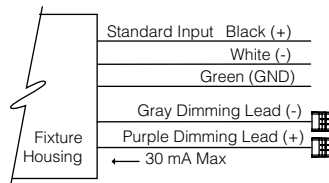
Support Arm:

- One-piece extruded aluminum with internal bolt guides and fully radiussed top and bottom.
- Luminaire-to-pole attachment is by internal draw bolts, and includes a pole reinforcing plate with wire strain relief.
- Arm is circular cut for specified round pole.
- Optional cast, low copper aluminum horizontal slip-fitter with adaptor plate to secure the luminaire to 2" IPS pipe size arms.

- Optional cast aluminum wall mount plate assembly. Attaches to the wall over the junction box. Luminaire attaches to the wall plate.

Finish:

- Fade and abrasion resistant, electrostatically applied, thermally cured, triglycidal isocyanurate (TGIC) polyester powdercoat.
- Standard colors include (BL) Black, (DB) Dark Bronze, (GT) Graphite, (WH) White, (PS) Platinum Silver, (LG) Light Gray, (TT) Titanium, and (CC) Custom Color (Include RAL#).

Fusing:

SF for 120, 277 and 347 Line Volts

DF for 208, 240 and 480 Line Volts.

- High temperature fuse holders factory installed inside the fixture housing. Fuse is included.

Certifications and Listings:

- UL 1598 Standard for wet locations for Luminaires.
- UL 8750 Standard for Safety for Light Emitting Diode (LED) Equipment for use in Lighting Products.
- IP66 certified.
- CSA C22.2#250.0 Luminaires.
- ANSI C136.31-2010 3G Vibration tested and compliant.
- RoHS compliant.
- IDA approved, 3000K and warmer CCTs only.

CAUTION:

- Fixtures must be grounded in accordance with national, state and/or local electrical codes, Failure to do so may result in serious personal injury.

WARRANTY:

- For full warranty see <http://www.hubbellighting.com/resources/warranty>

Kim Lighting reserves the right to change specifications without notice.

CONTROLS
Photocell Receptacle
A25-7

Fully gasketed and wired 7-pin receptacle option. Easy access location above the electrical compartment. 7-pin construction allows for a user-defined interface and provides a controlled definition of operational performance. ANSI twist-lock control module by-others.

Standard customer operation modes:

1. Traditional on/off photoelectric control.
2. 5-pin wireless photoelectric control for added dimming feature.
3. 7-pin wireless photoelectric control for dimming and additional I/O connections for customer use.

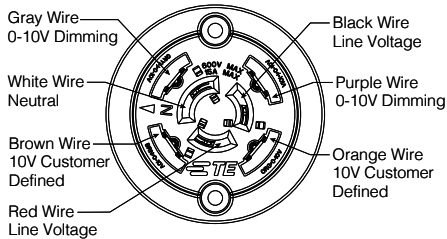
Button Photocell

A30 for 120V, **A31** for 208V, **A32** for 240V, **A33** for 277V, **A35** for 347V, **A34** for 480V,

Photocell is factory installed inside the housing with a fully gasketed sensor on the side wall. For multiple fixture mountings, one fixture is supplied with a photocell to operate the others.

Wireless Control

Hubbell Building Automation's wiSCAPE™ In-Fixture Module is a bi-directional wireless RF device that allows an individual fixture to be managed, monitored and metered. The wiSCAPE In-Fixture Module communicates wirelessly over a robust 2.4GHz ISM (Industrial, Scientific and Medical) certified meshed radio signal. The wiSCAPE Fixture Module drastically simplifies control and automation of projects, especially in retrofit environments, and challenges the legacy world of wired-systems. wiSCAPE wireless control technology easily adapts to complex automation situations for quick, simple and economical commissioning. The On-Fixture Module is compatible with A-25-7H option.

WIR-RMI-IO

120 - 347V 1000 Foot Range WiScape RF mesh control system with off/on/dim, motion, photo, GPS location, alert, monitoring and metering capabilities.

Pole Mounted
Round Pole-Mounted Occupancy Sensor up to 16'
SCL-R

Round Pole-Mounted Occupancy Sensor up to 16' - an outdoor occupancy sensor with 0-10V interface dimming control that mounts directly to the pole. Wide 360° pattern. Module colors are available in Black, Gray, and White. Module is cut for round pole mounting. Pole diameter is needed upon order. Poles to be drilled in the field will be provided with installation instructions.

Ordering Example: SCL-R4'/277²/BL³

Square Pole-Mounted Occupancy Sensor up to 16'
SCL-S

Square Pole-Mounted Occupancy Sensor up to 16' - an outdoor occupancy sensor with 0-10V interface dimming control that mounts directly to the pole. Wide 360° pattern. Module colors are available in Black, Gray, and White. Module is cut for square pole mounting. Pole diameter is needed upon order. Poles to be drilled in the field will be provided with installation instructions.

Ordering Example: SCL-L/277²/BL³

Round Pole-Mounted Occupancy Sensor 16' to 30'
SCH-R

Round Pole-Mounted Occupancy Sensor: 16' to 30' - an outdoor occupancy sensor with 0-10V interface dimming control that mounts directly to the pole. Wide 360° pattern. Module colors are available in Black, Gray, and White. Module is cut for round pole mounting. Pole diameter is needed upon order. Poles to be drilled in the field will be provided with installation instructions.

Ordering Example: SCH-R4'/277²/BL³

Square Pole-Mounted Occupancy Sensor 16' to 30'
SCH-S

Square Pole-Mounted Occupancy Sensor: 16 to 30' - an outdoor occupancy sensor with 0-10V interface dimming control that mounts directly to the pole. Wide 360° pattern. Module colors are available in Black, Gray, and White. Module is cut for round pole mounting. Pole diameter is needed upon order. Poles to be drilled in the field will be provided with installation instructions.

Ordering Example: SCH-S/277²/BL³

SCP

The SCP is a photo-control with motion sensing accessory that mounts to the side of any new or existing 3"-5" round or square straight pole. The SCP enables any pole mounted luminaire in excess of 75 watts, to meet California Title 24 requirements with integral 20KV/10KA surge protection for added reliability and serviceability.

For more detail:

http://www.aal.net/products/sensor_control_programmable

¹Pole Diameter, ²Voltage, ³Color

Kim Lighting reserves the right to change specifications without notice.