

JOB \_\_\_\_\_ TYPE \_\_\_\_\_  
 NOTES \_\_\_\_\_ APPROVALS \_\_\_\_\_

### FEATURES

- Full Cutoff PicoEmitter technology
- Available in 580nm, 3000K, 4000K and 5000K standard CCT
- Type 1, 2, 3, 4, 5, R & L distributions
- 0-10V dimming drivers standard
- Sealed optical chamber, IP66 certified

### Certifications



### SPECIFICATIONS

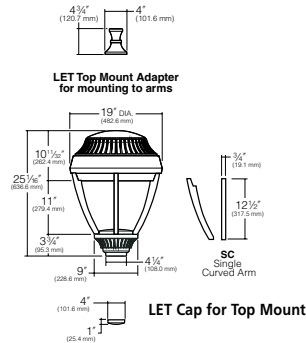

Approx. Weight = 54 lbs. EPA 0.7 for 1SA.  
 See Configuration for Additional EPAs.

### ORDERING CODE

Configuration	EPA	Fixture	Electrical Module	Fixture Finish	Photocell Options
<ul style="list-style-type: none"> <li>1SA 1 Arm Side Mt. 0.7</li> <li>2SB 2 Arm Side Mt. 1.4</li> <li>3SY 3 Arm Side Mt. 2.1</li> <li>4SC 4 Arm Side Mt. 2.4</li> <li>1W Single Wall Mt. n/a</li> </ul>		<b>LET19SC</b> Distribution Drive Current Source Color Temperature <sup>1</sup> Voltages	BL Black DB Dark Bronze GT Graphite LG Light Gray PS Platinum Silver TT Titanium WH White CC Custom Color*	A25-7 7-pin Photocell Receptacle A30 120V Button Photocell A31 208V Button Photocell A32 240V Button Photocell A33 277V Button Photocell A34 480V Button Photocell A35 347V Button Photocell	
NOTE: EPA is for Fixture only		1 Type I 2 Type II 3 Type III 4 Type IV 5 Type V R Type R Right L Type L Left	E35 350mA PicoEmitter 60L 60 LEDs, 67W 2K 580nm <sup>2</sup> 3K 3000K 4K 4000K 5K 5000K	UV 120-277V 120 120V 208 208V 240 240V 277 277V 347 <sup>3</sup> 347V 480 <sup>3</sup> 480V	* Consult Representative

Fuse Options	Lens Options	NFO Option	Control Options	Arm Options																																
SF 120, 277, 347 Line Volts DF 208, 240, 480 Line Volts	LS Polycarbonate Lens <sup>4</sup>	NFO Neighbor Friendly Optic. Photometry available for Type III/IV. All others, consult factory.	Wireless <b>WIR-RMI-IO</b> 120-480V, 1000' range, wiSCAPE RF control system with on/off/dim, alerts, monitoring and metering capabilities  Motion <b>SCL-R</b> Round Pole Mounted Occupancy Sensor up to 16' <b>SCL-S</b> Square Pole Mounted Occupancy Sensor up to 16' <b>SCH-R</b> Round Pole Mounted Occupancy Sensor 16' to 30' <b>SCH-S</b> Square Pole Mounted Occupancy Sensor 16' to 30'	<table border="1"> <thead> <tr> <th>Pole Arm</th> <th>Pole Tenon Mount</th> <th>Wall Mount</th> <th>Style</th> </tr> </thead> <tbody> <tr> <td>HA11S</td> <td>HA11S-TM1, HA11S-TM2, HA11S-TM3, HA11S-TM4</td> <td>HA11S-W</td> <td>Side Pole Swept Cast Arm</td> </tr> <tr> <td>HA12S</td> <td>HA12S-TM1, HA12S-TM2, HA12S-TM3, HA12S-TM4</td> <td>HA12S-W</td> <td>Side Pole S-Shaped Up Cast Arm</td> </tr> <tr> <td>HA14S</td> <td>HA14S-TM1, HA14S-TM2, HA14S-TM3, HA14S-TM4</td> <td>HA14S-W</td> <td>Side Pole Neo-Classic Arm</td> </tr> <tr> <td>HA31S</td> <td>HA31S-TM1, HA31S-TM2, HA31S-TM3, HA31S-TM4</td> <td>HA31S-W</td> <td>Side Pole Arm w/ Top Scroll</td> </tr> <tr> <td>HA33S</td> <td>HA33S-TM1, HA33S-TM2, HA33S-TM3, HA33S-TM4</td> <td>HA33S-W</td> <td>Side Pole Ribbon Arm w/Top Gusset</td> </tr> <tr> <td>HA37S</td> <td>HA37S-TM1</td> <td>HA37S-W</td> <td>Side Pole Ribbon w/ Top Brace, Bottom Scroll</td> </tr> <tr> <td>HA38S</td> <td>HA38S-TM1</td> <td>HA38S-W</td> <td>Side Pole Ribbon w/ Top Brace, Bottom Gusset</td> </tr> </tbody> </table>	Pole Arm	Pole Tenon Mount	Wall Mount	Style	HA11S	HA11S-TM1, HA11S-TM2, HA11S-TM3, HA11S-TM4	HA11S-W	Side Pole Swept Cast Arm	HA12S	HA12S-TM1, HA12S-TM2, HA12S-TM3, HA12S-TM4	HA12S-W	Side Pole S-Shaped Up Cast Arm	HA14S	HA14S-TM1, HA14S-TM2, HA14S-TM3, HA14S-TM4	HA14S-W	Side Pole Neo-Classic Arm	HA31S	HA31S-TM1, HA31S-TM2, HA31S-TM3, HA31S-TM4	HA31S-W	Side Pole Arm w/ Top Scroll	HA33S	HA33S-TM1, HA33S-TM2, HA33S-TM3, HA33S-TM4	HA33S-W	Side Pole Ribbon Arm w/Top Gusset	HA37S	HA37S-TM1	HA37S-W	Side Pole Ribbon w/ Top Brace, Bottom Scroll	HA38S	HA38S-TM1	HA38S-W	Side Pole Ribbon w/ Top Brace, Bottom Gusset
Pole Arm	Pole Tenon Mount	Wall Mount	Style																																	
HA11S	HA11S-TM1, HA11S-TM2, HA11S-TM3, HA11S-TM4	HA11S-W	Side Pole Swept Cast Arm																																	
HA12S	HA12S-TM1, HA12S-TM2, HA12S-TM3, HA12S-TM4	HA12S-W	Side Pole S-Shaped Up Cast Arm																																	
HA14S	HA14S-TM1, HA14S-TM2, HA14S-TM3, HA14S-TM4	HA14S-W	Side Pole Neo-Classic Arm																																	
HA31S	HA31S-TM1, HA31S-TM2, HA31S-TM3, HA31S-TM4	HA31S-W	Side Pole Arm w/ Top Scroll																																	
HA33S	HA33S-TM1, HA33S-TM2, HA33S-TM3, HA33S-TM4	HA33S-W	Side Pole Ribbon Arm w/Top Gusset																																	
HA37S	HA37S-TM1	HA37S-W	Side Pole Ribbon w/ Top Brace, Bottom Scroll																																	
HA38S	HA38S-TM1	HA38S-W	Side Pole Ribbon w/ Top Brace, Bottom Gusset																																	
<b>Mounting Options</b> HA Arm				Arm Finial HAF02																																
				Finial TF																																

For Pole Spec Select: [http://www.kimlighting.com/products/arms\\_and\\_poles/](http://www.kimlighting.com/products/arms_and_poles/)  
 For Control Spec Select: <http://trpsl.com/index.html>

<sup>1</sup> For custom optics and color temperature configurations, contact factory.  
<sup>2</sup> Turtle friendly. Maximum 500mA drive current for 2K amber option.  
<sup>3</sup> 347V & 480V currents may be supplied with step-down transformer.  
<sup>4</sup> Use only when vandalism is anticipated to be high. Required only for vandal protection in locations where fixtures can be reached by unauthorized persons.

Kim Lighting reserves the right to change specifications without notice.

**ARM OPTIONS**

**Note:** Refer to Kim Lighting's Arms and Poles Specification Guide for EPA information and additional information on arm, tenon and wall mounting.

**1W** Wall Mount arm is not included and must be ordered separately.

**Post Top Crook<sup>1</sup>**

ARM      Tenon Mount

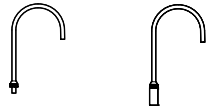

**HA01S      HA01S-TM1**

Mounting:    1SA   2SB   3SY   4SC

**Side Pole Crook<sup>1</sup>**

ARM      Tenon Mount      Wall Mt

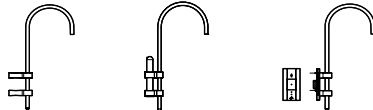

**HA02S      HA02S-TM1  
HA02S-TM2  
HA02S-TM3  
HA02S-TM4      HA02S-W**

Mounting:    1SA   2SB   3SY   4SC

**Post Top Swept Cast Arm<sup>1</sup>**

ARM      Tenon Mount

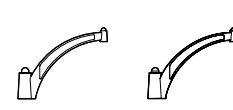

**HA03S      HA03S-TM1  
HA03S-TM1  
HA03S-TM1  
HA03S-TM1**

Mounting:    1SA   2SB   3SY   4SC

**Side Pole Swept Cast Arm**

ARM      Tenon Mount      Wall Mt

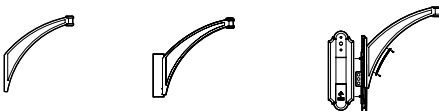

**HA11S      HA11S-TM1  
HA11S-TM2  
HA11S-TM3  
HA11S-TM4      HA11S-W**

Mounting:    1SA   2SB   3SY   4SC

**Side Pole S-Shaped Up Cast Arm**

ARM      Tenon Mount      Wall Mt

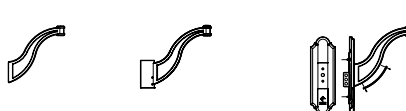

**HA12S      HA12S-TM1  
HA12S-TM2  
HA12S-TM3  
HA12S-TM4      HA12S-W**

Mounting:    1SA   2SB   3SY   4SC

**Side Pole Neo-Classic Arm<sup>1</sup>**

ARM      Tenon Mount      Wall Mt

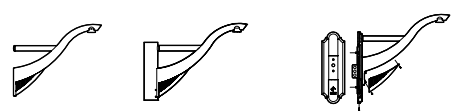

**HA14S      HA14S-TM1  
HA14S-TM2  
HA14S-TM3  
HA14S-TM4      HA14S-W**

Mounting:    1SA   2SB   3SY   4SC

**Side Pole Arm w/Top Scroll**

ARM      Tenon Mount      Wall Mt



**HA31S      HA31S-TM1  
HA31S-TM2  
HA31S-TM3  
HA31S-TM4      HA31S-W**

Mounting:    1SA   2SB   3SY   4SC

**Side Pole Ribbon Arm w/Top Gusset**

ARM      Tenon Mount      Wall Mt



**HA33S      HA33S-TM1  
HA33S-TM2  
HA33S-TM3  
HA33S-TM4      HA33S-W**

Mounting:    1SA   2SB   3SY   4SC

**Side Pole Ribbon Arm w/Top Brace**

ARM      Tenon Mount      Wall Mt

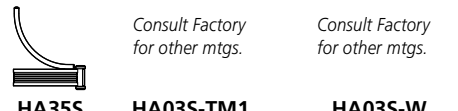

**HA35S      HA03S-TM1      HA03S-W**

Mounting:    1SA   2SB   3SY   4SC

**Side Pole Ribbon Arm w/Top Brace & Bottom Scroll**

ARM      Tenon Mount      Wall Mt

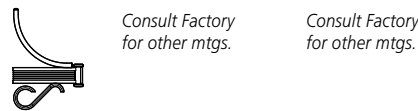

**HA37S      HA37S-TM1      HA37S-W**

Mounting:    1SA   2SB   3SY   4SC

**Side Pole Ribbon Arm w/Top Brace & Bottom Gusset**

ARM      Tenon Mount      Wall Mt

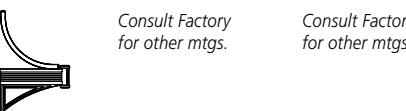

**HA38S      HA38S-TM1  
HA38S-TM2  
HA38S-TM3  
HA38S-TM4      HA38S-W**

Mounting:    1SA   2SB   3SY   4SC

**Arm Finial**

**HAF02** Traditional style finial available to close off mounting hub opposite fixture.



<sup>1</sup>Not available on arm where indicated.

**Finial**

**TF** Heavy cast aluminum finial on top of lantern housing. For use with Bottom Mount (BM) luminaire only.

Kim Lighting reserves the right to change specifications without notice.

**LUMINAIRE PERFORMANCE**

Spectroradiometric			
	3000K Average	4000K Average	5000K Average
Color Rendering Index (CRI)	≤80	≤80	≤70
Power Factor	>.90	>.90	>.90

Projected Lumen Maintenance		
mA	100,000 hrs	(Calculated L70)
350 mA	93.33%	596,000 hrs.

Electrical Drive Current		
Volts - AC	Amps - AC	System Watts
120	0.56	67
208	0.32	67
240	0.28	67
277	0.24	67
347	0.19	67
480	0.14	67

B.U.G. Rating (TM15) in Lumens wher B = Backlight, U = Uplight, G = Glare								
Temperature	TYPE 1	TYPE 2	TYPE 3	TYPE 3 NFO	TYPE 4	TYPE 4 NFO	TYPE 5	TYPE L/R
3000K	TBD	B1 U0 G1	B1 U0 G1	N/A	B1 U0 G1	B0 U0 G1	B2 U0 G1	TBD
4000K	TBD	B2 U0 G2	B1 U0 G1	N/A	B1 U0 G1	B1 U0 G1	B2 U0 G1	TBD
5000K	TBD	B2 U0 G2	B1 U0 G1	N/A	B1 U0 G1	B1 U0 G1	B3 U0 G1	TBD

Absolute Lumens								
Temperature	TYPE 1	TYPE 2	TYPE 3	TYPE 3 NFO	TYPE 4	TYPE 4 NFO	TYPE 5	TYPE L/R
3000K	TBD	3714	3522	N/A	3507	2951	3685	TBD
4000K	TBD	4822	4573	N/A	4553	3830	4784	TBD
5000K	TBD	5159	4892	N/A	4871	4098	5118	TBD

LED performance and lumen output continues to improve at a rapid pace. Log onto [www.kimlighting.com](http://www.kimlighting.com) to download the most current photometric files from Kim Lighting's IES File Library. For custom optics and color temperature configurations, contact factory.  
 \*Data is prorated from 5000K IES files.

Kim Lighting reserves the right to change specifications without notice.

**SPECIFICATIONS**
**Housing:**

- One-piece die-cast, low copper (<0.6% Cu) aluminum alloy with integral cooling ribs over the optical chamber and electrical compartment.
- Solid barrier wall separates optical and electrical compartments.
- Double-thick wall with gussets on the support-arm mounting end.
- Housing forms a half cylinder with 55° front face plane providing a recess to allow a flush single-latch detail.
- All hardware is stainless steel or electro-zinc plated steel.

**Lens Frame:**

- One-piece die-cast, low copper (<0.6% Cu) aluminum alloy lens frame with 1" minimum depth around the gasket flange.
- Integral hinges with stainless steel pins provide no-tool mounting and removal from housing.
- Single die-cast aluminum cam-latch provides positive locking and sealing of the optical chamber by a one-piece extruded and vulcanized silicone gasket to provide an IP66 rating for the optical module.
- Clear 3/8" thick tempered glass lens retained by eight steel clips with full silicone gasketing around the perimeter.

**Neighbor Friendly Optic**

- Integrated Neighbor Friendly Optic on each PicoEmitter module to completely control unwanted backlight. Most effective with Type III and IV distributions.

**Lens:**

- One-piece clear tempered glass lens sealed with silicone gasket.

**Optical Module:**

- Precision, replaceable PicoEmitters are positioned to achieve directional control toward desired task.
- The entire EmitterDeck fastens to the housing as a one-piece module.
- Type I, II, III, IV, V, L (left), and R (right) standard distributions. Custom available.
- 3000K, 4000K, 5000K standard CCT. Amber and custom available.
- IP66 certified
- Die-cast, low copper aluminum heat sink

modules provide thermal transfer at PCB level.

- Anodized aluminum carrier plate and heat sink modules.

**Electrical Characteristics:**

- 120V through 480V @ 50/60Hz.
- Class 1, 350mA.
- Power Factor = >.90
- National Electrical Code, ANSI/NFPA 70.
- 10kV surge suppression.
- Thermalshield thermal control.
- -40c starting driver.
- 0-10V dimming interface.
- All electronic components are IP66 rated.
- Electronic components are UL and/or CSA recognized.

**Dimming:**

- 10% to 100% dimming using standard 0-10V interface driver.
- To activate the dimming system, a wiring harness is supplied and attached to the DIM Port (DIM IN) on the thermal shield protection system. This port allows the 0-10V Interface to bypass the thermal shield and control the driver.
- The thermal shield works in conjunction with the control system to assure that overheating will not harm the LEDs.

The wiring harness is connected with the use of the Purple lead as the positive (+) and the Grey lead as the negative (-) to an available control signal (by others).

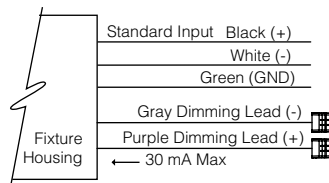
**Support Arm:**

- One-piece extruded aluminum with internal bolt guides and fully radiussed top and bottom.
- Luminaire-to-pole attachment is by internal draw bolts, and includes a pole reinforcing plate with wire strain relief.
- Arm is circular cut for specified round pole.
- Optional cast, low copper aluminum horizontal slip-fitter with adaptor plate to secure the luminaire to 2" IPS pipe size arms.

- Optional cast aluminum wall mount plate assembly. Attaches to the wall over the junction box. Luminaire attaches to the wall plate.

**Finish:**

- Fade and abrasion resistant, electrostatically applied, thermally cured, triglycidal isocyanurate (TGIC) polyester powdercoat.
- Standard colors include (BL) Black, (DB) Dark Bronze, (GT) Graphite, (WH) White, (PS) Platinum Silver, (LG) Light Gray, (TT) Titanium, and (CC) Custom Color (Include RAL#).

**Fusing:**

**SF** for 120, 277 and 347 Line Volts

**DF** for 208, 240 and 480 Line Volts.

- High temperature fuse holders factory installed inside the fixture housing. Fuse is included.

**Certifications and Listings:**

- UL 1598 Standard for wet locations for Luminaires.
- UL 8750 Standard for Safety for Light Emitting Diode (LED) Equipment for use in Lighting Products.
- IP66 certified.
- CSA C22.2#250.0 Luminaires.
- ANSI C136.31-2010 3G Vibration tested and compliant.
- RoHS compliant.
- IDA approved, 3000K and warmer CCTs only.

**CAUTION:**

- Fixtures must be grounded in accordance with national, state and/or local electrical codes, Failure to do so may result in serious personal injury.

**WARRANTY:**

- For full warranty see <http://www.hubbellighting.com/resources/warranty>

Kim Lighting reserves the right to change specifications without notice.

**CONTROLS**
**Photocell Receptacle**
**A25-7**

Fully gasketed and wired 7-pin receptacle option. Easy access location above the electrical compartment. 7-pin construction allows for a user-defined interface and provides a controlled definition of operational performance. ANSI twist-lock control module by-others.

Standard customer operation modes:

1. Traditional on/off photoelectric control.
2. 5-pin wireless photoelectric control for added dimming feature.
3. 7-pin wireless photoelectric control for dimming and additional I/O connections for customer use.

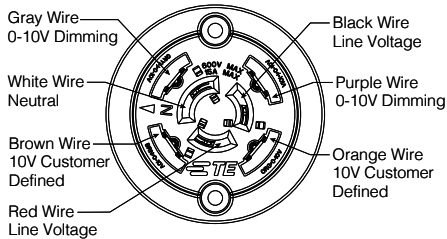
**Button Photocell**

**A30** for 120V, **A31** for 208V, **A32** for 240V, **A33** for 277V, **A35** for 347V, **A34** for 480V,

Photocell is factory installed inside the housing with a fully gasketed sensor on the side wall. For multiple fixture mountings, one fixture is supplied with a photocell to operate the others.

**Wireless Control**

Hubbell Building Automation's wiSCAPE™ In-Fixture Module is a bi-directional wireless RF device that allows an individual fixture to be managed, monitored and metered. The wiSCAPE In-Fixture Module communicates wirelessly over a robust 2.4GHz ISM (Industrial, Scientific and Medical) certified meshed radio signal. The wiSCAPE Fixture Module drastically simplifies control and automation of projects, especially in retrofit environments, and challenges the legacy world of wired-systems. wiSCAPE wireless control technology easily adapts to complex automation situations for quick, simple and economical commissioning. The On-Fixture Module is compatible with A-25-7H option.

**WIR-RMI-IO**

120 - 347V 1000 Foot Range WiScape RF mesh control system with off/on/dim, motion, photo, GPS location, alert, monitoring and metering capabilities.

**Pole Mounted**
**Round Pole-Mounted Occupancy Sensor up to 16'**
**SCL-R**

Round Pole-Mounted Occupancy Sensor up to 16' - an outdoor occupancy sensor with 0-10V interface dimming control that mounts directly to the pole. Wide 360° pattern. Module colors are available in Black, Gray, and White. Module is cut for round pole mounting. Pole diameter is needed upon order. Poles to be drilled in the field will be provided with installation instructions.

Ordering Example: SCL-R4/277<sup>2</sup>/BL<sup>3</sup>

**Square Pole-Mounted Occupancy Sensor up to 16'**
**SCL-S**

Square Pole-Mounted Occupancy Sensor up to 16' - an outdoor occupancy sensor with 0-10V interface dimming control that mounts directly to the pole. Wide 360° pattern. Module colors are available in Black, Gray, and White. Module is cut for square pole mounting. Pole diameter is needed upon order. Poles to be drilled in the field will be provided with installation instructions.

Ordering Example: SCL-L/277<sup>2</sup>/BL<sup>3</sup>

**Round Pole-Mounted Occupancy Sensor 16' to 30'**
**SCH-R**

Round Pole-Mounted Occupancy Sensor: 16' to 30' - an outdoor occupancy sensor with 0-10V interface dimming control that mounts directly to the pole. Wide 360° pattern. Module colors are available in Black, Gray, and White. Module is cut for round pole mounting. Pole diameter is needed upon order. Poles to be drilled in the field will be provided with installation instructions.

Ordering Example: SCH-R4/277<sup>2</sup>/BL<sup>3</sup>

**Square Pole-Mounted Occupancy Sensor 16' to 30'**
**SCH-S**

Square Pole-Mounted Occupancy Sensor: 16 to 30' - an outdoor occupancy sensor with 0-10V interface dimming control that mounts directly to the pole. Wide 360° pattern. Module colors are available in Black, Gray, and White. Module is cut for round pole mounting. Pole diameter is needed upon order. Poles to be drilled in the field will be provided with installation instructions.

Ordering Example: SCH-S/277<sup>2</sup>/BL<sup>3</sup>

**SCP**

The SCP is a photo-control with motion sensing accessory that mounts to the side of any new or existing 3"-5" round or square straight pole. The SCP enables any pole mounted luminaire in excess of 75 watts, to meet California Title 24 requirements with integral 20KV/10KA surge protection for added reliability and serviceability.

For more detail:

[http://www.aal.net/products/sensor\\_control\\_programmable](http://www.aal.net/products/sensor_control_programmable)

<sup>1</sup>Pole Diameter, <sup>2</sup>Voltage, <sup>3</sup>Color